

Solutions for the mining industry

Special cables for highest demands in the mining sector



Solutions for the mining industry

Special cables for highest demands in the mining sector

General catalogue

Linking the Future

As the worldwide leader in the cable industry, Prysmian Group believes in the effective, efficient and sustainable supply of energy and information as a primary driver in the development of communities.

With this in mind, we provide major global organisations in many industries with best-in-class cable solutions, based on state-of-the-art technology. Through two renowned commercial brands - Prysmian and Draka - based in almost 50 countries, we're constantly close to our customers, enabling them to further develop the world's energy and telecoms infrastructures, and achieve sustainable, profitable growth.

In our energy business, we design, produce, distribute and install cables and systems for the transmission and distribution of power at low, medium, high and extra-high voltage.

In telecoms, the Group is a leading manufacturer of all types of copper and fibre cables, systems and accessories - covering voice, video and data transmission.

Drawing on over 130 years' experience and continuously investing in R&D, we apply excellence, understanding and integrity to everything we do, meeting and exceeding the precise needs of our customers across all continents, at the same time shaping the evolution of our industry.

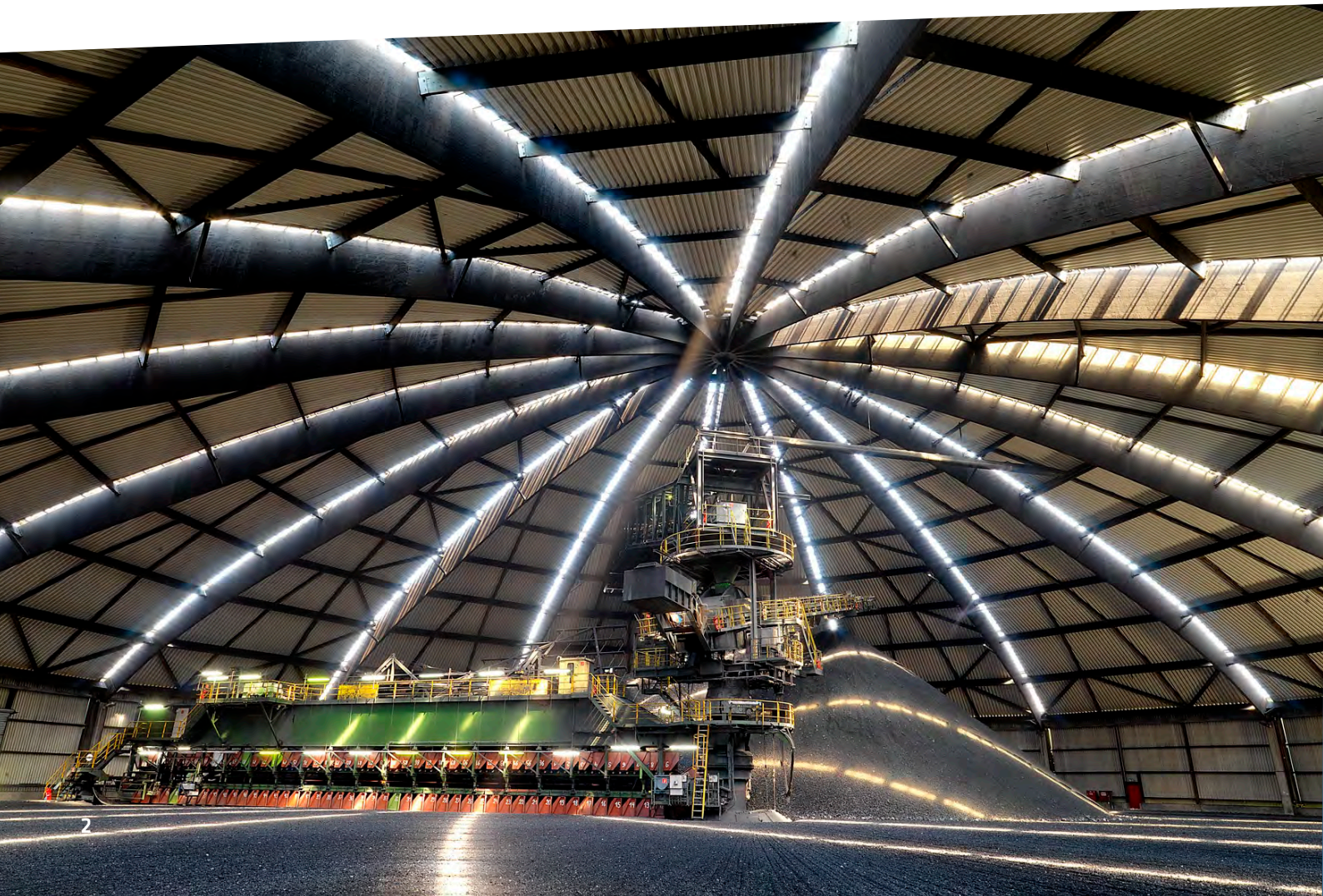



What links global expertise to the wheels of industry?

High-performing cable solutions to keep the wheels of industry turning

On every continent, in applications that range from air and rail transport infrastructure to heavy duty industries such as mining, tunnel drilling and defence, Prysmian's specialist cable solutions sit at the heart of significant international projects; supporting the work of major customers, with high-performing, durable and safe technology.

As the world leader in cabling, we draw on global expertise and local presence to work in close proximity with our customers,

delivering products and service platforms, built on easy contact, customised solutions and effective supply chains, meeting their specialised requirements, to help them drive the wheels of industry and achieve sustainable growth and profitability. As the worldwide leader in the cable industry, Prysmian Group believes in the effective, efficient and sustainable supply of energy and information as a primary driver in the development of communities.



Mining cables

Introduction

The development of elastomeric power cables for safe and reliable mining and industrial applications has paralleled the development of the electric motor and power generation since the 19th century.

Elastomeric cables are the natural choice for applications where durability, flexibility, and safe operation under extreme environmental conditions are important. The Prysmian Group's elastomeric cables have been "field proven" in thousands of operations, and with continuous development, utilise the best features of cables offered around the world.

In Germany, as elsewhere, there are many established guidelines governing manufacture of mining and industrial cables.

Innovation in work practices, with more equipment operating at higher voltages, has required the continued development of new elastomeric cable designs. Ongoing development programs have also been required to continually improve the reliability and safety of current designs. The major design responsibility for the Prysmian Group is to ensure that cables supplied will operate reliably and safely under a wide range of conditions. Personnel often work close to energised cables, especially in underground mines. The cable construction and materials must be selected to provide maximum safety during both normal operation and in the case of cable failure.



Application

Opencast and underground mining requires ever-increasing performance of machines and methods. This has led to the large machines in use today. On bucket wheel and dragline excavators for instance, installed power of more than 15 MW and voltages up to 35 kV are no longer unusual.

These large, movable machines require medium voltage flexible reeling and trailing cables for power supply and are suitable for operation under the most extreme conditions.

Prysmian and Draka branded reeling and trailing cables for opencast and underground mining have been field-proven worldwide for decades.

In these mining applications, particular requirements such as mechanical strength and safety have led to the use of high-grade mechanically resistant rubber.

Prysmian Group has developed extensive know-how over many years about the special operational conditions of opencast and underground mining. The decisive factor was close cooperation with many significant mining companies.

The experience we gain every day contributes to the design of our mining cables. The high operational reliability and service life of Prysmian's reeling and trailing cables for mining is based on this experience.



Benefits

Prysmian Group's Mining & Tunnelling cables offer significant benefits to a broad variety of specialized mining professionals such as OEMs, specifiers, contractors, installers, mining companies and more. These benefits include:

Unique Mechanical Performance

Prysmian Group's Mining and Tunnelling cables have been designed to withstand extreme conditions in terms of:

- Tensile loads
- Torsional stresses occurring during misalignment of cable guidance systems and oblique pay out
- Minimum bending radius at any ambient temperature range and stress conditions
- High travel speeds and acceleration

Chemical and Climate Resistance

Prysmian Group's Mining and Tunnelling cables have been designed to withstand the most severe conditions. For these applications Prysmian has developed the high performance compounds that are used in Mining and Tunnelling cables to guarantee resistance to extreme conditions (such as high-speed, oil and fuel, mud, moisture, and acids and basis), as well as to harsh environments (for instance, extreme low/hot temperature, UV irradiation and ozone).



Miniaturised

Prysmian Group's Mining and Tunnelling cables have the smallest possible dimensions. For instance, in MV cables:

- Dimension - up to 30% less and yet in strict compliance with the existing standards
- Weight - higher cable performance allow up to a 40% reduction in the cable weight
- Robustness - higher physical/mechanical resistance, exceeding standard requirements in terms of abrasion, cut-through and repeated bending

Customised and Multifunctional Engineering

Prysmian designs, compounds and builds cables according to specific customer needs. This allows us to have an exhaustive product range covering all functionalities (MV/LV, Instrumentation and Control, Optical fibres). Prysmian designs multifunctional cables from the simplest to the most sophisticated.

Longer Lifetime

Prysmian Group's Mining and Tunnelling cables guarantee an extended working lifetime (lower failure rate) in comparison with standard and traditional mining and tunneling cables. As a consequence the total cost of ownership is lower.

Mining cables



Index

Opencast Mining

Opencast Applications	page 12
Medium voltage reeling cables	page 14
PROTOLON(M)-R	page 16
PROTOLON(M)-R FO	page 22
TENAX M	page 28
Medium voltage trailing cables	page 34
TENAX SAS	page 36
PROTOLON (SB-SAM)	page 40
PROTOLON (SB-SAM) Screen	page 44
Medium voltage dredge cables	page 48
PROTOLON (ST) .../3E	page 50
PROTOLON (ST) NTSCGEW0EU	page 56
PROTOLON (M)-F	page 62
Cables for semi-flexible installation	page 66
PROTOLON (M)-F	page 68
PROTOMONT NSSHOEU	page 72
PROTOMONT (M) (N)SHOEU	page 76
PROTOMONT EMV-FC (N)SSHCOEU	page 80
Medium voltage single core cables	page 82
FELTOFLEX	page 84
PROTOLON NTMCGCW0EU	page 92
PROTOLON (M) NTMCGCW0EU	page 96
Control and signaling cables	page 100
OPTOFLEX (M)	page 102
PROTOMONT (MSR) 2YSLGCG0EU	page 104
L-2YY(Z)Y KF 40	page 106

Mining cables

Underground Mining

Underground Applications	page 108
Shearer cables for chain application	page 110
PROTOMONT (V) 1 kV	page 112
PROTOMONT (V) 3kV & 6kV	page 114
PROTOMONT (VO)	page 116
TENAX CTE	page 118
Shearer cables for free trailing	page 120
PROTOMONT (Z) NSSHKCGEOEU	page 122
Underground reeling cables	page 124
TENAX-LK	page 126
PROTOMONT(S)	page 128
CORDAFLEX (S) NSHTOEU	page 130
PROTOMONT (M+)	page 132
TBM Reeling	page 134
PROTOMONT TBM	page 136
TENAX HTT	page 140
Cables for semi-fixed installation	page 144
PROTOMONT Festoon	page 146
SUPROMONT (N)3GHSSYCY	page 148
PROTOMONT NSSHOEU .../3E	page 154
PROTOMONT (EMV-FC)	page 156
Cables according to BS 6708	page 158
Type 7-7M-7S-11	page 160
Type 307-307M-307S	page 162
Type 201-211	page 164
Type 62-63-64	page 166
Type 321-331	page 168
Type 631	page 170
Type 506-512-518-524	page 172

Technical Annex

Type / Trademark	page 175
Type / Type designation	page 176
Approvals / Standards	page 178
Colour coding of fibre-optics	page 180
Installation and handling of reeling cables	page 180
Installation and handling of underground mining cables	page 183
Installation and handling of opencast trailing cables	page 184
Laying instructions for OPTOFLEX (M) cables	page 185
Centre feeding point	page 186
Determination of the sag on mast mounting	page 187
Electrical field control in hybrid sealing ends	page 188
Stripping semiconductive layers	page 189
Sealing ends	page 190
Couplers and cable services	page 192
Electrical parameters	page 193
Monitoring of flexible cables in underground operations	page 200
Thermal parameters	page 201
Mechanical parameters	page 203
Chemical parameters	page 212
Conductors	page 214
Compounds	page 218
Shield	page 220
Electrical field control with cables	page 221
Core arrangement	page 222
Support elements	page 224
Anti-torsion braid	page 225
Cable drum overview	page 226
Comparison	page 227
Worldwide Prysmian Group mining cables acc. to local standards	page 228

Opencast Applications

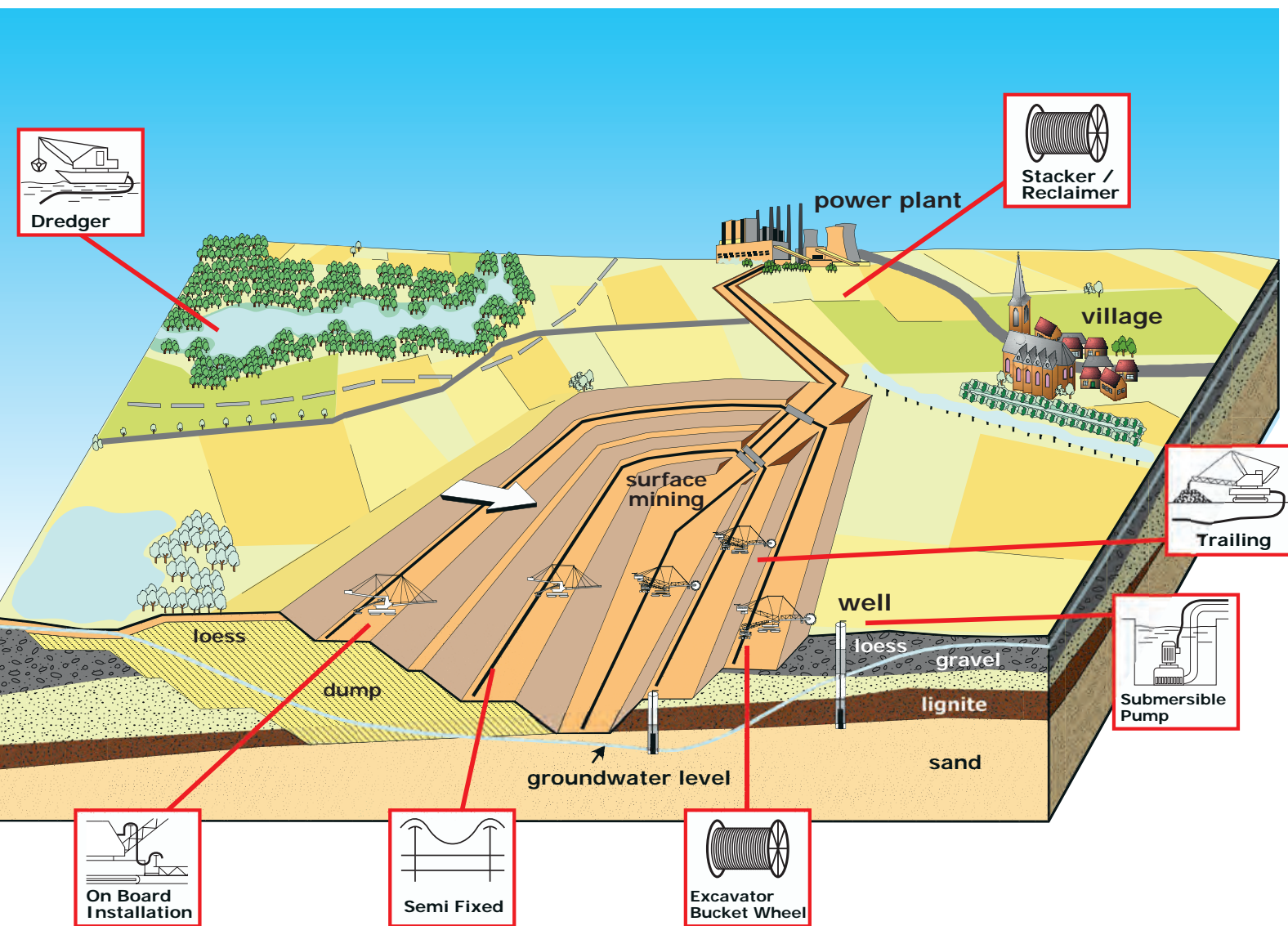

Application Groups

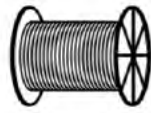

Stacker/
Reclaimer



Bunker,
Drills



Trailing

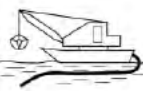

Dredge

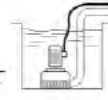

submer-
sible
pump

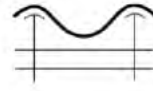

semi-
fixed

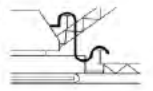

semi-
fixed

MV Reeling

PROTOLON(M)-R

+

+

-

-

-

+

+

PROTOLON(M)-R FO

+

+

-

-

-

+

+

TENAX M

+

+

-

-

-

+

+

MV Trailing

TENAX SAS

-

-

+

-

-

+

+

PROTOLON(SB-SAM)

-

-

+

-

-

+

+

PROTOLON(SB-SAM)screen

-

-

+

-

-

+

+

MV Dredge

PROTOLON(ST)..3E

-

-

-

+

+

+

+

PROTOLON(ST)

-

-

-

+

+

+

+

PROTOLON(M)-F

-

-

-

+

+

+

+

Semi-flexible

PROTOLON(M)-F

-

-

-

-

+

+

+

PROTOMONT NSSHOEU

-

-

-

-

+

+

+

PROTOMONT (EMV FC)

-

-

-

-

+

+

+

PROTOMONT(M) (N)SHOEU

-

-

-

-

+

+

+

MV Single core

FELTOFLEX NTMCWOEU

-

-

-

-

-

+

+

PROTOLON NTMCGCWOEU

-

-

-

-

-

+

+

PROTOLON(M) (N)TM..

-

-

-

-

-

+

+

Control and Signaling

OPTOFLEX(M)

-

-

-

-

-

+

+

PROTOMONT(MSR)

-

-

-

-

-

+

+

L-2YY(Z)Y-KF40

-

-

-

-

-

+

+

+

main application

+

suitable

-

not suitable

Opencast Mining



MEDIUM VOLTAGE REELING CABLES

	PROTOLON(M)-R	PROTOLON(M)-R FO	TENAX M
Travel speed	max. 60m/min	max. 60m/min	max. 30m/min
Permissible tensile force	20N/mm ²	20N/mm ²	15N/mm ²
Stability against torsion	+/- 100°/m	+/- 100°/m	+/- 50°/m
Sheath quality	5GM5	5GM5	5GM3+
Reversed bending stability	+++	+++	++
Flexibility	+++	+++	++
Resistance against water	+++	+++	++
S-bendings in operation	Multiple planes	Multiple planes	Single plane
Fully flexible temperature range	-35°C to +60°C	-35°C to +60°C	-25°C to +60°C
Approvals	Fire Certificate, Gost K, Gost B	Fire Certificate, Gost K, Gost B	

PROTOLON(M)-R

Medium voltage reeling cable without integrated fiber-optics



Application

For connection of large material handling machines such as excavators, dumpers, mobile crusher in open-cast mines. Flexible MV reeling cable suitable for high mechanical stresses in conjunction with mono spiral reels and cylindrical reels.

Global data

Brand	PROTOLON(M)
Type designation	R-(N)TSCGEW0EU
Standard	Based on DIN VDE 0250-813
Certifications / Approvals	MSHA P-189-4 Fire Certificate of Russian Federation GOST K GOST B

Notes on installation

Notes on installation Suitable material sets for self-assembly or termination at manufacturer's factory workshop.

Design features

Conductor	Electrolytic copper, not tinned, very finely stranded (class FS)
Insulation	PROTOLON, Basic material: EPR, Compound type: better 3GI3
Electrical field control	Inner and outer layer of semiconductive rubber compound
Core identification	Natural coloring with black semiconductive rubber on which white digits 1 to 3 are printed
Core arrangement	Three main conductors laid-up, with protective-earth conductor split into 3 in the outer interstices
Inner sheath	Basic material: EPR, Compound type: 5GM3
Reinforcement	Braid of polyester threads in a vulcanized bond between inner and outer sheath
Outer sheath	Basic material: Synthetic elastomer compound e.g. CR, Compound type: better 5GM5, Color: Red

Electrical parameters

Rated voltage	3.6/6 kV	6/10 kV	8.7/15 kV	12/20 kV	14/25 kV	18/30 kV	20/35 kV
Maximum permissible operating voltage AC	4.2/7.2 kV	6.9/12 kV	10.4/18 kV	13.9/24 kV	17.3/30 kV	20.8/36 kV	24.2/42 kV
Maximum permissible operating voltage DC	5.4/10.8 kV	9/18 kV	13.5/27 kV	18/36 kV	22.5/45 kV	27/54 kV	31.5/63 kV
AC test voltage	11 kV	17 kV	24 kV	29 kV	36 kV	43 kV	50 kV

Chemical parameters

Resistance to fire	EN 60332-1-2, IEC 60332-1-2
Resistance to oil	EN 60811-404, IEC 60811-404
Weather resistance	Unrestricted use outdoors and indoors, resistant to ozone, UV and moisture

Thermal parameters

Max. permissible temperature at conductor	90 °C
Max. short circuit temperature of the conductor	250 °C
Ambient temperature for fix installation min.	-40 °C
Ambient temperature for fix installation max.	80 °C
Ambient temperature in fully flexible operation min.	-35 °C
Ambient temperature in fully flexible operation max.	60 °C

Mechanical parameters

Tensile load on the conductor max .	20 N/mm ²
Max. tensile load on the conductor during acceleration	25 N/mm ²
Torsional stress	100 °/m
Bending radii min.	Acc. to DIN VDE 0298 part 3
Minimum distance with S-type directional changes	20 x D
Travel speed	In operation: up to 60 m/min On rewinding: up to 100 m/min
Additional tests	Reversed bending test, torsional stress test, roller bending test (type C)

Rated voltage 3.6/6 kV

Number of cores x cross section	Part number	Conductor diameter max. mm	Outer diameter min. mm	Outer diameter max. mm	Net weight approx. kg/km	Permissible tensile force max. N	Conductor resistance at 20°C max. Ω/km	Nom. operating capacitance μF/km	Inductance nom. mH/km	Current carrying capacity (1) A	Short Circuit Current (conductor) kA
3x25+3x25/3	20007613	7.1	35.5	38.5	2220	1500	0.78	0.37	0.31	131	3.58
3x25+3x50/3		7.1	39.9	42.9	2760	1500	0.78	0.37	0.35	131	3.58
3x35+3x25/3	20007426	8.4	39.3	42.3	2780	2100	0.554	0.43	0.3	162	5.01
3x35+3x50/3		8.4	42.2	45.2	3190	2100	0.554	0.43	0.32	162	5.01
3x50+3x25/3	20007893	10.1	42.8	45.8	3440	3000	0.386	0.49	0.28	202	7.15
3x50+3x50/3		10.1	42.8	45.8	3620	3000	0.386	0.49	0.3	202	7.15
3x70+3x35/3	20156763	11.8	46.6	49.6	4350	4200	0.272	0.55	0.27	250	10.01
3x70+3x50/3		11.8	46.6	49.6	4450	4200	0.272	0.55	0.27	250	10.01
3x95+3x50/3	20004527	13.8	51.5	55.5	5630	5700	0.206	0.63	0.26	301	13.6
3x120+3x70/3	20004525	15.5	55.2	59.2	6780	7200	0.161	0.7	0.25	352	17.16
3x150+3x70/3	20004528	17.4	59.2	63.2	8000	9000	0.129	0.76	0.25	404	21.45
3x185+3x95/3	20007425	19.2	64.4	68.4	9610	11100	0.106	0.82	0.24	462	26.46
3x240+3x120/3	20014799	22.1	70.6	74.6	12220	14400	0.08	0.93	0.24	540	34.32
3x300+3x150/3	20014797	24.7	77.5	81.5	14950	18000	0.064	1.03	0.23	620	42.9

Rated voltage 6/10 kV

Number of cores x cross section	Part number	Conductor diameter max. mm	Outer diameter min. mm	Outer diameter max. mm	Net weight approx. kg/km	Permissible tensile force max. N	Conductor resistance at 20°C max. Ω/km	Nom. operating capacitance μF/km	Inductance nom. mH/km	Current carrying capacity (1) A	Short Circuit Current (conductor) kA
3x25+3x25/3	20007429	7.1	36.8	39.8	2320	1500	0.78	0.33	0.32	131	3.58
3x25+3x50/3		7.1	41.3	44.3	2880	1500	0.78	0.33	0.32	131	3.58
3x35+3x25/3	20006949	8.4	40.5	43.5	2880	2100	0.554	0.38	0.31	162	5.01
3x35+3x50/3	20018359	8.4	42.9	45.9	3270	2100	0.554	0.38	0.31	162	5.01
3x50+3x25/3	20008746	10.1	44.1	47.1	3560	3000	0.386	0.43	0.29	202	7.15
3x50+3x50/3	20031763	10.1	44.1	47.1	3730	3000	0.386	0.43	0.29	202	7.15
3x70+3x35/3	20004607	11.8	47.9	50.9	4480	4200	0.272	0.49	0.28	250	10.01
3x70+3x50/3	20004608	11.8	47.9	50.9	4590	4200	0.272	0.49	0.28	250	10.01
3x95+3x50/3	20004611	13.8	52.8	56.8	5770	5700	0.206	0.56	0.27	301	13.6
3x120+3x70/3	20001446	15.5	56.4	60.4	6930	7200	0.161	0.62	0.26	352	17.16
3x150+3x70/3	20007824	17.4	61.9	65.9	8330	9000	0.129	0.67	0.25	404	21.45
3x185+3x95/3		19.2	65.7	69.7	9790	11100	0.106	0.73	0.25	462	26.46
3x240+3x120/3		22.1	73.3	77.3	12570	14400	0.08	0.82	0.24	540	34.32
3x300+3x150/3		24.7	78.7	82.7	15060	18000	0.064	0.91	0.24	620	42.9

Rated voltage 8.7/15 kV

Number of cores x cross section	Part number	Conductor diameter max. mm	Outer diameter min. mm	Outer diameter max. mm	Net weight approx. kg/km	Permissible tensile force max. N	Conductor resistance at 20°C max. Ω/km	Nom. operating capacitance μF/km	Inductance nom. mH/km	Current carrying capacity (1) A	Short Circuit Current (conductor) kA
3x25+3x25/3		7.1	41.1	44.1	2700	1500	0.78	0.26	0.34	139	3.58
3x25+3x50/3		7.1	43.6	46.6	3080	1500	0.78	0.26	0.34	139	3.58
3x35+3x25/3		8.4	43.9	46.9	3190	2100	0.554	0.29	0.33	172	5.01
3x35+3x50/3		8.4	43.9	46.9	3380	2100	0.554	0.29	0.33	172	5.01
3x50+3x25/3		10.1	47.5	50.5	3890	3000	0.386	0.33	0.31	215	7.15
3x50+3x50/3	20004682	10.1	47.5	50.5	4080	3000	0.386	0.33	0.31	215	7.15
3x70+3x35/3		11.8	52	56	5010	4200	0.272	0.38	0.3	265	10.01
3x70+3x50/3		11.8	52	56	5130	4200	0.272	0.38	0.3	265	10.01
3x95+3x50/3	20004683	13.8	56.2	60.2	6180	5700	0.206	0.41	0.29	319	13.6
3x120+3x70/3		15.5	61.3	65.3	7580	7200	0.161	0.45	0.28	371	17.16
3x150+3x70/3		17.4	65.3	69.3	8980	9000	0.129	0.5	0.27	428	21.45
3x185+3x95/3		19.2	69.1	73.1	10280	11100	0.106	0.54	0.26	488	26.46
3x240+3x120/3		22.1	76.6	80.6	13110	14400	0.08	0.6	0.26	574	34.32
3x300+3x150/3		24.7	83.5	88.5	16010	18000	0.064	0.66	0.25	665	42.9

Rated voltage 12/20 kV

Number of cores x cross section	Part number	Conductor diameter max. mm	Outer diameter min. mm	Outer diameter max. mm	Net weight approx. kg/km	Permissible tensile force max. N	Conductor resistance at 20°C max. Ω/km	Nom. operating capacitance μF/km	Inductance nom. mH/km	Current carrying capacity (1) A	Short Circuit Current (conductor) kA
3x25+3x25/3	20008326	7.1	44.1	47.1	2970	1500	0.78	0.23	0.36	139	3.58
3x25+3x50/3		7.1	44.1	47.1	3160	1500	0.78	0.23	0.36	139	3.58
3x35+3x25/3	20025024	8.4	46.8	49.8	3470	2100	0.554	0.26	0.34	172	5.01
3x35+3x50/3		8.4	46.8	49.8	3660	2100	0.554	0.26	0.34	172	5.01
3x50+3x25/3	20142156	10.1	51.3	55.3	4370	3000	0.386	0.29	0.32	215	7.15
3x50+3x50/3	20015893	10.1	51.3	55.3	4540	3000	0.386	0.29	0.32	215	7.15
3x70+3x35/3		11.8	55	59	5360	4200	0.272	0.33	0.31	265	10.01
3x70+3x50/3		11.8	55	59	5470	4200	0.272	0.33	0.31	265	10.01
3x95+3x50/3	20004728	13.8	59.2	63.2	6550	5700	0.206	0.37	0.3	319	13.6
3x120+3x70/3		15.5	64.2	68.2	7980	7200	0.161	0.4	0.29	371	17.16
3x150+3x70/3		17.4	68.2	72.2	9380	9000	0.129	0.44	0.28	428	21.45
3x185+3x95/3		19.2	73.4	77.4	10990	11100	0.106	0.48	0.27	488	26.46
3x240+3x120/3		22.1	79.6	83.6	13620	14400	0.08	0.54	0.26	574	34.32
3x300+3x150/3		24.7	86.4	91.4	16560	18000	0.064	0.59	0.26	665	42.9

Rated voltage 14/25 kV

Number of cores x cross section	Part number	Conductor diameter max. mm	Outer diameter min. mm	Outer diameter max. mm	Net weight approx. kg/km	Permissible tensile force max. N	Conductor resistance at 20°C max. Ω/km	Nom. operating capacitance μF/km	Inductance nom. mH/km	Current carrying capacity (1) A	Short Circuit Current (conductor) kA
3x25+3x25/3		7.1	47.9	50.9	3360	1500	0.78	0.2	0.38	139	3.58
3x25+3x50/3		7.1	47.9	50.9	3540	1500	0.78	0.2	0.38	139	3.58
3x35+3x25/3		8.4	51.5	55.5	4050	2100	0.554	0.22	0.36	172	5.01
3x35+3x50/3		8.4	51.5	55.5	4240	2100	0.554	0.22	0.36	172	5.01
3x50+3x25/3		10.1	55.2	59.2	4820	3000	0.386	0.25	0.34	215	7.15
3x50+3x50/3		10.1	55.2	59.2	5010	3000	0.386	0.25	0.34	215	7.15
3x70+3x35/3		11.8	58.8	62.8	5830	4200	0.272	0.28	0.33	265	10.01
3x70+3x50/3	20008713	11.8	58.8	62.8	5940	4200	0.272	0.28	0.33	265	10.01
3x95+3x50/3		13.8	64.4	68.4	7280	5700	0.206	0.31	0.31	319	13.6
3x120+3x70/3		15.8	68	72	8520	7200	0.161	0.34	0.3	371	17.16
3x150+3x70/3		17.4	73.4	77.4	10230	9000	0.129	0.37	0.29	428	21.45
3x185+3x95/3		19.2	77.3	81.3	11610	11100	0.106	0.4	0.28	488	26.46
3x240+3x120/3		22.1	84.7	89.7	14660	14400	0.08	0.45	0.27	574	34.32
3x300+3x150/3		24.7	90.2	95.2	17280	18000	0.74	0.49	0.27	665	42.9

Rated voltage 18/30 kV

Number of cores x cross section	Part number	Conductor diameter max. mm	Outer diameter min. mm	Outer diameter max. mm	Net weight approx. kg/km	Permissible tensile force max. N	Conductor resistance at 20°C max. Ω/km	Nom. operating capacitance μF/km	Inductance nom. mH/km	Current carrying capacity (1) A	Short Circuit Current (conductor) kA
3x25+3x25/3		7.1	52.2	56.2	3900	1500	0.78	0.18	0.4	139	3.58
3x25+3x50/3		7.1	52.2	56.2	4090	1500	0.78	0.18	0.4	139	3.58
3x35+3x25/3		8.4	55	59	4450	2100	0.554	0.19	0.38	172	5.01
3x35+3x50/3		8.4	55	59	4640	2100	0.554	0.19	0.38	172	5.01
3x50+3x25/3		10.1	58.6	62.6	5250	3000	0.386	0.22	0.36	215	7.15
3x50+3x50/3		10.1	58.6	62.6	5430	3000	0.386	0.22	0.36	215	7.15
3x70+3x35/3		11.8	63.6	67.6	6500	4200	0.272	0.24	0.34	265	10.01
3x70+3x50/3	20004740	11.8	63.6	67.6	6610	4200	0.272	0.24	0.34	265	10.01
3x95+3x50/3		13.8	67.8	71.8	7770	5700	0.206	0.27	0.33	319	13.6
3x120+3x70/3	20006962	15.5	72.8	76.8	9280	7200	0.161	0.29	0.31	371	17.16
3x150+3x70/3		17.4	76.9	80.9	10780	9000	0.129	0.32	0.3	428	21.45
3x185+3x95/3		19.2	80.6	84.6	12170	11100	0.106	0.34	0.3	488	26.46
3x240+3x120/3		22.1	88.1	93.1	15280	14400	0.08	0.38	0.28	574	34.32
3x300+3x150/3		24.7	94.6	99.6	18200	18000	0.064	0.42	0.28	665	42.9

Rated voltage 20/35 kV

Number of cores x cross section	Part number	Conductor diameter max. mm	Outer diameter min. mm	Outer diameter max. mm	Net weight approx. kg/km	Permissible tensile force max. N	Conductor resistance at 20°C max. Ω/km	Nom. operating capacitance μF/km	Inductance nom. mH/km	Current carrying capacity (1) A	Short Circuit Current (conductor) kA
3x25+3x25/3		7.1	56.8	60.8	4450	1500	0.78	0.16	0.42	139	3.58
3x35+3x25/3		8.4	61.1	65.1	5260	2100	0.554	0.18	0.4	172	5.01
3x50+3x25/3		10.1	64.6	68.6	6080	3000	0.386	0.2	0.37	215	7.15
3x50+3x50/3		10.1	64.6	68.6	6270	3000	0.386	0.2	0.37	215	7.15
3x70+3x35/3		11.8	68.2	72.2	7160	4200	0.272	0.23	0.36	265	10.01
3x70+3x50/3	20004750	11.8	68.2	72.2	7260	4200	0.272	0.25	0.36	265	10.01

(1) Ambient temperature 30°C

PROTOLON(M)-R FO

Medium voltage reeling cable with integrated fiber-optics



Application

For connection of large material handling machines such as excavators, dumpers, mobile crushers in open-cast mines. Flexible MV reeling cable suitable for high mechanical stresses in conjunction with mono-spiral reels and cylindrical reels.

Global data

Brand	PROTOLON(M)-R LWL
Type designation	R-(N)TSCGEW0EU
Standard	Based on DIN VDE 0250-813
Certifications / Approvals	MSHA P-189-4 Fire Certificate of Russian Federation GOST K GOST B

Notes on installation

Notes on installation Suitable material sets for self-assembly.

Termination of fiber-optics requires special skills and the use of elaborate tools. Therefore, it is recommended that the assembly should be entrusted to our customer service (to be completed at the manufacturer's plant). Please provide the connection dimensions.

Design features

Conductor	Electrolytic copper, not tinned, very finely stranded (class FS)
Insulation	PROTOLON, Basic material: EPR, Compound type: Special compound, better 3GI3
Electrical field control	Inner and outer layer of semiconductive rubber compound
Core identification	Natural coloring with black semiconductive rubber on which white digits 1 to 3 are printed
Optical Fiber	Inner core diameter of fiber 9 μm, 62.5 μm or 50 μm; Diameter over cladding 125 μm; Diameter over coating 250 μm; Designs up to 24 fibers available.
	Fiber G50/125 Attenuation at 850 nm: <2.8 dB/km Attenuation at 1310 nm: <0.8 dB/km Bandwidth at 850 nm: >400 MHz Bandwidth at 1300 nm: >1200 MHz Numerical aperture: 0.20 +/- 0.02
	Fiber G62.5/125 Attenuation at 850 nm: <3.3 dB/km Attenuation at 1310 nm: <0.9 dB/km Bandwidth at 850 nm: >400 MHz Bandwidth at 1300 nm: >600 MHz Numerical aperture: 0.275 +/- 0.02
	Fiber E9/125 Attenuation at 1310 nm: <0.4 dB/km Attenuation at 1550 nm: <0.3 dB/km Numerical aperture: 0.14 +/- 0.02 Chromatic dispersion at 1300 nm: <3.5 ps/nm km Chromatic dispersion at 1550 nm: <3.5 ps/nm km
Fiber coding	Color coding of the fibers and buffering tube for identification of the fiber type
Fiber covering	Hollow core with filling compound, Basic material: ETFE, Compound: 7YI 1, Natural color
Arrangement of fiber optic elements	Six cores in one layer, especially laid-up around the supporting element
Core arrangement	Three-core design, protective-earth conductor split into two and fiber-optic element in the outer interstices
Inner sheath	Basic material: EPR, Compound type: Special compound type 5GM3
Reinforcement	Braid of polyester threads in a vulcanized bond between inner and outer sheath
Outer sheath	Basic material: Synthetic elastomer compound e.g. CR, Compound type: Special compound, Color: Red

Electrical parameters

Rated voltage	3.6/6 kV	6/10 kV	8.7/15 kV	12/20 kV	14/25 kV	18/30 kV	20/35 kV
Maximum permissible operating voltage AC	4.2/7.2 kV	6.9/12 kV	10.4/18 kV	13.9/24 kV	17.3/30 kV	20.8/36 kV	24.2/42 kV
Maximum permissible operating voltage DC	5.4/10.8 kV	9/18 kV	13.5/27 kV	18/36 kV	22.5/45 kV	27/54 kV	31.5/63 kV
AC test voltage	11 kV	17 kV	24 kV	29 kV	36 kV	43 kV	50 kV

Chemical parameters

Resistance to fire	EN 60332-1-2, IEC 60332-1-2
Resistance to oil	EN 60811-404, IEC 60811-404
Weather resistance	Unrestricted use outdoors and indoors, resistant to ozone, UV and moisture

Thermal parameters

Max. permissible temperature at conductor	90 °C
Max. short circuit temperature of the conductor	250 °C
Ambient temperature for fix installation min.	-40 °C
Ambient temperature for fix installation max.	80 °C
Ambient temp. in fully flex. operation min.	-35 °C
Ambient temp. in fully flex. operation max.	60 °C

Mechanical parameters

Tensile load on the conductor max .	20 N/mm ²
Max. tensile load on the conductor during acceleration	25 N/mm ²
Torsional stress	100 °/m
Bending radii min.	Acc. to DIN VDE 0298 part 3
Minimum distance with S-type directional changes	20 x D
Travel speed	In operation: up to 60 m/min On rewinding: up to 100 m/min
Additional tests	Reversed bending test, torsional stress test, roller bending test (type C)

Rated voltage 3.6/6 kV

Number of cores x cross section	Conductor diameter max. mm	Outer diameter min. mm	Outer diameter max. mm	Net weight approx. kg/km	Permissible tensile force max. N	Conductor resistance at 20°C max. Ω/km	Nom. operating capacitance μF/km	Inductance nom. mH/km	Current carrying capacity (1) A	Short Circuit Current (conductor) kA
3x25+ 2x25/2+FO	7.1	40	43	2590	1500	0.78	0.37	0.35	131	3.58
3x25+ 2x50/2+FO	7.1	42.6	45.6	2900	1500	0.78	0.37	0.38	131	3.58
3x35+ 2x25/2+FO	8.4	41.6	44.6	2960	2100	0.554	0.43	0.32	162	5.01
3x35+ 2x50/2+FO	8.4	44.5	47.5	3300	2100	0.554	0.43	0.35	162	5.01
3x50+ 2x25/2+FO	10.1	42.8	45.8	3430	3000	0.386	0.49	0.28	202	7.15
3x50+ 2x50/2+FO	10.1	46.4	49.4	3950	3000	0.386	0.49	0.31	202	7.15
3x70+ 2x35/2+FO	11.8	46.4	49.4	4350	4200	0.272	0.55	0.27	250	10.01
3x70+ 2x50/2+FO	11.8	49.8	53.8	4700	4200	0.272	0.55	0.29	250	10.01
3x95+ 2x50/2+FO	13.8	51.5	55.5	5630	5700	0.206	0.63	0.26	301	13.6
3x120+ 2x70/2+FO	15.5	55.2	59.2	6800	7200	0.161	0.7	0.25	352	17.16
3x150+ 2x70/2+FO	17.4	59.2	63.2	7970	9000	0.129	0.76	0.25	404	21.45
3x185+ 2x95/2+FO	19.2	64.4	68.4	9630	11100	0.106	0.82	0.24	462	26.46
3x240+ 2x120/2+FO	22.1	70.6	74.6	12160	14400	0.08	0.93	0.24	540	34.32
3x300+ 2x150/2+FO	24.7	77.5	81.5	14880	18000	0.064	1.03	0.23	620	42.9

(1) Ambient temperature 30°C

Please indicate number of fibers and fiber mode

Rated voltage 6/10 kV

Number of cores x cross section	Conductor diameter max. mm	Outer diameter min. mm	Outer diameter max. mm	Net weight approx. kg/km	Permissible tensile force max. N	Conductor resistance at 20°C max. Ω/km	Nom. operating capacitance μF/km	Inductance nom. mH/km	Current carrying capacity (1) A	Short Circuit Current (conductor) kA
3x25+ 2x25/2+FO	7.1	41.3	44.3	2660	1500	0.78	0.33	0.35	131	3.58
3x25+ 2x50/2+FO	7.1	43.6	46.6	2900	1500	0.78	0.33	0.38	131	3.58
3x35+ 2x25/2+FO	8.4	42.9	45.9	3070	2100	0.554	0.38	0.33	162	5.01
3x35+ 2x50/2+FO	8.4	45.2	48.2	3500	2100	0.554	0.38	0.35	162	5.01
3x50+ 2x25/2+FO	10.1	44.1	47.1	3560	3000	0.386	0.43	0.29	202	7.15
3x50+ 2x50/2+FO	10.1	47.8	50.8	3900	3000	0.386	0.43	0.32	202	7.15
3x70+ 2x35/2+FO	11.8	47.7	50.7	4480	4200	0.272	0.49	0.28	250	10.01
3x70+ 2x50/2+FO	11.8	51.2	55.2	5010	4200	0.272	0.49	0.3	250	10.01
3x95+ 2x50/2+FO	13.8	52.8	56.8	5770	5700	0.206	0.56	0.27	301	13.6
3x120+ 2x70/2+FO	15.5	56.4	60.4	6950	7200	0.161	0.62	0.25	352	17.16
3x150+ 2x70/2+FO	17.4	61.9	65.9	8350	9000	0.129	0.67	0.25	404	21.45
3x185+ 2x95/2+FO	19.2	65.7	69.7	9810	11100	0.106	0.73	0.24	462	26.46
3x240+ 2x120/2+FO	22.1	73.3	77.3	12600	14400	0.08	0.82	0.24	540	34.32
3x300+ 2x150/2+FO	24.7	78.7	82.7	15090	18000	0.064	0.91	0.23	620	42.9

Please indicate number of fibers and fiber mode
(1) Ambient temperature 30°C

Rated voltage 8.7/15 kV

Number of cores x cross section	Conductor diameter max. mm	Outer diameter min. mm	Outer diameter max. mm	Net weight approx. kg/km	Permissible tensile force max. N	Conductor resistance at 20°C max. Ω/km	Nom. operating capacitance μF/km	Inductance nom. mH/km	Current carrying capacity (1) A	Short Circuit Current (conductor) kA
3x25+ 2x25/2+FO	7.1	43.6	46.6	2910	1500	0.78	0.26	0.36	139	3.58
3x25+ 2x50/2+FO	7.1	45.9	48.9	3250	1500	0.78	0.26	0.38	139	3.58
3x35+ 2x25/2+FO	8.4	43.9	46.9	3180	2100	0.554	0.29	0.33	172	5.01
3x35+ 2x50/2+FO	8.4	47.5	50.5	3600	2100	0.554	0.29	0.35	172	5.01
3x50+ 2x25/2+FO	10.1	47.5	50.5	3900	3000	0.386	0.33	0.31	215	7.15
3x50+ 2x50/2+FO	10.1	51	55	4500	3000	0.386	0.33	0.32	215	7.15
3x70+ 2x35/2+FO	11.8	52	56	5020	4200	0.272	0.37	0.3	265	10.01
3x70+ 2x50/2+FO	11.8	52	56	5130	4200	0.272	0.37	0.3	265	10.01
3x95+ 2x50/2+FO	13.8	56.2	60.2	6180	5700	0.206	0.41	0.28	319	13.6
3x120+ 2x70/2+FO	15.5	61.3	65.3	7600	7200	0.161	0.45	0.27	371	17.16
3x150+ 2x70/2+FO	17.4	65.3	69.3	8820	9000	0.129	0.5	0.27	428	21.45
3x185+ 2x95/2+FO	19.2	69.1	73.1	10300	11100	0.106	0.54	0.26	488	26.46
3x240+ 2x120/2+FO	22.1	76.6	80.6	13140	14400	0.08	0.6	0.25	574	34.32
3x300+ 2x150/2+FO	24.7	83.5	88.5	16040	18000	0.064	0.66	0.25	665	42.9

Please indicate number of fibers and fiber mode
(1) Ambient temperature 30°C

Rated voltage 12/20 kV

Number of cores x cross section	Conductor diameter max. mm	Outer diameter min. mm	Outer diameter max. mm	Net weight approx. kg/km	Permissible tensile force max. N	Conductor resistance at 20°C max. Ω/km	Nom. operating capacitance μF/km	Inductance nom. mH/km	Current carrying capacity (1) A	Short Circuit Current (conductor) kA
3x25+ 2x25/2+FO	7.1	44.1	47.1	2980	1500	0.78	0.23	0.36	139	3.58
3x25+ 2x50/2+FO	7.1	47	50	3300	1500	0.78	0.23	0.39	139	3.58
3x35+ 2x25/2+FO	8.4	46.8	49.8	3480	2100	0.554	0.26	0.34	172	5.01
3x35+ 2x50/2+FO	8.4	50.3	54.3	4000	2100	0.554	0.26	0.36	172	5.01
3x50+ 2x25/2+FO	10.1	51.3	55.3	4370	3000	0.386	0.3	0.32	215	7.15
3x50+ 2x50/2+FO	10.1	51.3	55.3	4450	3000	0.386	0.3	0.32	215	7.15
3x70+ 2x35/2+FO	11.8	55	59	5370	4200	0.272	0.33	0.31	265	10.01
3x70+ 2x50/2+FO	11.8	55	59	5480	4200	0.272	0.33	0.31	265	10.01
3x95+ 2x50/2+FO	13.8	59.2	63.2	6550	5700	0.206	0.37	0.3	319	13.6
3x120+ 2x70/2+FO	15.5	64.2	68.2	8000	7200	0.161	0.41	0.29	371	17.16
3x150+ 2x70/2+FO	17.4	68.2	72.2	9240	9000	0.129	0.44	0.28	428	21.45
3x185+ 2x95/2+FO	19.2	73.4	77.4	11010	11100	0.106	0.48	0.27	488	26.46
3x240+ 2x120/2+FO	22.1	79.6	83.6	13650	14400	0.08	0.54	0.26	574	34.32
3x300+ 2x150/2+FO	24.7	86.4	91.4	16590	18000	0.064	0.59	0.26	665	42.9

Please indicate number of fibers and fiber mode
(1) Ambient temperature 30°C

Rated voltage 14/25 kV

Number of cores x cross section	Conductor diameter max. mm	Outer diameter min. mm	Outer diameter max. mm	Net weight approx. kg/km	Permissible tensile force max. N	Conductor resistance at 20°C max. Ω/km	Nom. operating capacitance μF/km	Inductance nom. mH/km	Current carrying capacity (1) A	Short Circuit Current (conductor) kA
3x25+ 2x25/2+FO	7.1	47.9	50.9	3360	1500	0.78	0.2	0.38	139	3.58
3x25+ 2x50/2+FO	7.1	47.9	50.9	3440	1500	0.78	0.2	0.4	139	3.58
3x35+ 2x25/2+FO	8.4	51.5	55.5	4050	2100	0.554	0.22	0.36	172	5.01
3x35+ 2x50/2+FO	8.4	51.5	55.5	4130	2100	0.554	0.22	0.36	172	5.01
3x50+ 2x25/2+FO	10.1	55.2	59.2	4830	3000	0.386	0.26	0.34	215	7.15
3x50+ 2x50/2+FO	10.1	55.2	59.2	4900	3000	0.386	0.26	0.34	215	7.15
3x70+ 2x35/2+FO	11.8	58.8	62.8	5840	4200	0.272	0.28	0.32	265	10.01
3x70+ 2x50/2+FO	11.8	58.8	62.8	5950	4200	0.272	0.28	0.32	265	10.01
3x95+ 2x50/2+FO	13.8	64.4	68.4	7280	5700	0.206	0.31	0.31	319	13.6
3x120+ 2x70/2+FO	15.5	68	72	8530	7200	0.161	0.35	0.3	371	17.16
3x150+ 2x70/2+FO	17.4	73.4	77.4	10080	9000	0.129	0.37	0.29	428	21.45
3x185+ 2x95/2+FO	19.2	77.3	81.3	11630	11100	0.106	0.4	0.28	488	26.46
3x240+ 2x120/2+FO	22.1	84.7	89.7	14690	14400	0.08	0.45	0.27	574	34.32
3x300+ 2x150/2+FO	24.7	90.2	95.2	17310	18000	0.064	0.5	0.26	665	42.9

Please indicate number of fibers and fiber mode
(1) Ambient temperature 30°C

Rated voltage 18/30 kV

Number of cores x cross section	Conductor diameter max. mm	Outer diameter min. mm	Outer diameter max. mm	Net weight approx. kg/km	Permissible tensile force max. N	Conductor resistance at 20°C max. Ω/km	Nom. operating capacitance μF/km	Inductance nom. mH/km	Current carrying capacity (1) A	Short Circuit Current (conductor) kA
3x25+ 2x25/2+FO	7.1	52.2	56.2	3900	1500	0.78	0.18	0.4	139	3.58
3x25+ 2x50/2+FO	7.1	52.2	56.2	3980	1500	0.78	0.18	0.4	139	3.58
3x35+ 2x25/2+FO	8.4	55	59	4450	2100	0.554	0.2	0.38	172	5.01
3x35+ 2x50/2+FO	8.4	55	59	4530	2100	0.554	0.2	0.38	172	5.01
3x50+ 2x25/2+FO	10.1	58.6	62.6	5250	3000	0.386	0.22	0.35	215	7.15
3x50+ 2x50/2+FO	10.1	58.6	62.6	5320	3000	0.386	0.22	0.35	215	7.15
3x70+ 2x35/2+FO	11.8	63.6	67.6	6510	4200	0.272	0.25	0.34	265	10.01
3x70+ 2x50/2+FO	11.8	63.6	67.6	6610	4200	0.272	0.25	0.34	265	10.01
3x95+ 2x50/2+FO	13.8	67.8	71.8	7770	5700	0.206	0.27	0.33	319	13.6
3x120+ 2x70/2+FO	15.5	72.8	76.8	9230	7200	0.161	0.29	0.31	371	17.16
3x150+ 2x70/2+FO	17.4	76.9	80.9	10630	9000	0.129	0.32	0.3	428	21.45
3x185+ 2x95/2+FO	19.2	80.6	84.6	12190	11100	0.106	0.34	0.3	488	26.46
3x240+ 2x120/2+FO	22.1	88.1	93.1	15310	14400	0.08	0.38	0.28	574	34.32
3x300+ 2x150/2+FO	24.7	94.6	99.6	18220	18000	0.064	0.42	0.28	665	42.9

Please indicate number of fibers and fiber mode
(1) Ambient temperature 30°C

Rated voltage 20/35 kV

Number of cores x cross section	Conductor diameter max. mm	Outer diameter min. mm	Outer diameter max. mm	Net weight approx. kg/km	Permissible tensile force max. N	Conductor resistance at 20°C max. Ω/km	Nom. operating capacitance μF/km	Inductance nom. mH/km	Current carrying capacity (1) A	Short Circuit Current (conductor) kA
3x25+ 2x25/2+FO	7.1	56.8	60.8	4450	1500	0.78	0.16	0.42	139	3.58
3x35+ 2x25/2+FO	8.4	61.1	65.1	5250	2100	0.554	0.18	0.4	172	5.01
3x50+ 2x25/2+FO	10.1	64.6	68.6	6080	3000	0.386	0.2	0.37	215	7.15
3x50+ 2x35/2+FO	10.1	64.6	68.6	6160	3000	0.386	0.2	0.37	215	7.15
3x70+ 2x35/2+FO	11.8	68.2	72.2	7160	4200	0.272	0.23	0.36	265	10.01

(1) Ambient temperature 30°C
Please indicate number of fibers and fiber mode

TENAX M

Medium voltage reeling cable



Application

Medium voltage reeling cable as power feeder cable for large mobile equipment such as excavators and spreaders, construction machines, etc. The cable design is specialized for reeling applications with mono-spiral reels and cylindrical reels with single plane guiding systems.

Global data

Brand	TENAX-M
Type designation	(N)TSCGEW0EU
Standard	Based on DIN VDE 0250-813

Design features

Conductor	Plain copper, finely stranded, class 5 according to DIN EN 60228 / VDE 0295
Insulation	Rubber, Compound type: 3GI3
Electrical field control	Inner and outer layer of semiconductive rubber compound
Core arrangement	Cores layed up around conductive filler with aramid rope in the center
Inner sheath	Rubber, special compound, mechanical properties acc. to 5GM3
Outer sheath	Abrasion and tear proof special rubber compound, quality better 5GM3 acc. to DIN VDE 0207 part 21, resistance to ozone, UV and oil.
	Sheath color: Red or Black

Electrical parameters

Rated voltage	3.6/6 kV	6/10 kV	8.7/15 kV	12/20 kV	14/25 kV	18/30 kV	20/35 kV
Maximum permissible operating voltage AC	4.2/7.2 kV	6.9/12 kV	10.4/18 kV	13.9/24 kV	17.3/30 kV	20.8/36 kV	24.2/42 kV
Maximum permissible operating voltage DC	5.4/10.8 kV	9/18 kV	13.5/27 kV	18/36 kV	22.5/45 kV	27/54 kV	31.5/63 kV
AC test voltage	11 kV	17 kV	24 kV	29 kV	36 kV	43 kV	50 kV

Chemical parameters

Resistance to fire	EN 60332-1, IEC 60332-1
Resistance to oil	EN 60811-404, IEC 60811-404
Weather resistance	Unrestricted use outdoors and indoors, resistant to ozone, UV and moisture

Thermal parameters

Max. permissible temperature at conductor	90 °C
Max. short circuit temperature of the conductor	250 °C
Ambient temperature for fix installation min.	-40 °C
Ambient temperature for fix installation max.	80 °C
Ambient temp. in fully flex. operation min.	-25 °C
Ambient temp. in fully flex. operation max.	60 °C

Mechanical parameters

Max. tensile load of cable	15 N/mm ²
Torsional stress	50 °/m
Bending radii min.	Acc. to DIN VDE 0298 part 3
Minimum distance with S-type directional changes	20 X D
Travel speed	Up to 30 m/min

Mechanical parameters

Tensile load on the conductor max .	20 N/mm ²
Max. tensile load on the conductor during acceleration	25 N/mm ²
Torsional stress	100 °/m
Bending radii min.	Acc. to DIN VDE 0298 part 3
Minimum distance with S-type directional changes	20 x D
Travel speed	In operation: up to 60 m/min On rewinding: up to 100 m/min
Additional tests	Reversed bending test, torsional stress test, roller bending test (type C)

Rated voltage 3.6/6 kV

Number of cores x cross section	Conductor diameter max. mm	Outer diameter min. mm	Outer diameter max. mm	Net weight approx. kg/km	Permissible tensile force max. N	Conductor resistance at 20°C max. Ω/km	Nom. operating capacitance μF/km	Inductance nom. mH/km	Current carrying capacity (1) A	Short Circuit Current (conductor) kA
3x25+3x25/3	6.21	33.7	36.2	1950	1125	0.78	0.34	0.33	131	3.58
3x25+3x50/3	6.21	33.7	36.2	2050	1125	0.78	0.34	0.33	131	3.58
3x35+3x25/3	7.8	37.2	39.7	2450	1575	0.55	0.4	0.31	162	5.01
3x35+3x50/3	7.8	37.2	39.7	2500	1575	0.55	0.4	0.31	162	5.01
3x50+3x25/3	9.56	42.3	44.8	3200	2250	0.39	0.47	0.29	202	7.15
3x50+3x50/3	9.56	42.3	44.8	3200	2250	0.39	0.47	0.29	202	7.15
3x70+3x35/3	11.06	45.6	48.1	4000	3150	0.27	0.52	0.28	250	10.01
3x70+3x50/3	11.06	45.6	48.1	4150	3150	0.27	0.52	0.28	250	10.01
3x95+3x50/3	12.6	48.9	52.4	4900	4275	0.21	0.58	0.27	301	13.59
3x120+3x70/3	14.8	55	58.5	6150	5400	0.16	0.66	0.26	352	17.16
3x150+3x70/3	15.95	57.5	61	7100	6750	0.13	0.7	0.25	404	21.45
3x185+3x95/3	17.7	63	66.5	8700	8325	0.11	0.77	0.25	461	26.46
3x240+3x120/3	20.2	68.4	71.9	10500	10800	0.08	0.86	0.24	544	34.32
3x300+3x150/3	22.68	75.5	79	13200	13500	0.06	0.95	0.24	626	42.9

(1) Nominal current carrying capacity for rubber cables laid on a surface, at 30°C ambient temperature (see also VDE 0298-4, Table 15).

Rated voltage 6/10 kV

Number of cores x cross section	Conductor diameter max. mm	Outer diameter min. mm	Outer diameter max. mm	Net weight approx. kg/km	Permissible tensile force max. N	Conductor resistance at 20°C max. Ω/km	Nom. operating capacitance μF/km	Inductance nom. mH/km	Current carrying capacity (1) A	Short Circuit Current (conductor) kA
3x25+3x25/3	6.21	34.9	37.4	2050	1125	0.78	0.31	0.34	135	3.58
3x25+3x50/3	6.21	34.9	37.4	2100	1125	0.78	0.31	0.34	135	3.58
3x35+3x25/3	7.8	39.7	42.2	2650	1575	0.55	0.36	0.31	172	5.01
3x35+3x50/3	7.8	39.7	42.2	2700	1575	0.55	0.36	0.31	172	5.01
3x50+3x25/3	9.56	43.5	46	3300	2250	0.39	0.42	0.3	216	7.15
3x50+3x50/3	9.56	43.5	46	3300	2250	0.39	0.42	0.3	216	7.15
3x70+3x35/3	11.06	46.7	49.2	4100	3150	0.27	0.46	0.28	265	10.01
3x70+3x50/3	11.06	46.7	49.2	4300	3150	0.27	0.46	0.28	265	10.01
3x95+3x50/3	12.6	51.4	54.9	5150	4275	0.21	0.52	0.27	319	13.59
3x120+3x70/3	14.8	56.1	59.6	6250	5400	0.16	0.59	0.26	371	17.16
3x150+3x70/3	15.95	58.6	62.1	7200	6750	0.13	0.62	0.26	428	21.45
3x185+3x95/3	17.7	64.2	67.7	8850	8325	0.11	0.68	0.25	488	26.46
3x240+3x120/3	20.2	69.5	73	10650	10800	0.08	0.76	0.25	575	34.32
3x300+3x150/3	22.68	76.7	80.2	13350	13500	0.06	0.84	0.24	662	42.9

(1) Nominal current carrying capacity for rubber cables laid on a surface, at 30°C ambient temperature (see also VDE 0298-4, Table 15).

Rated voltage 8.7/15 kV

Number of cores x cross section	Conductor diameter max. mm	Outer diameter min. mm	Outer diameter max. mm	Net weight approx. kg/km	Permissible tensile force max. N	Conductor resistance at 20°C max. Ω/km	Nom. operating capacitance μF/km	Inductance nom. mH/km	Current carrying capacity (1) A	Short Circuit Current (conductor) kA
3x25+3x25/3	6.21	39.3	41.8	2400	1125	0.78	0.23	0.37	135	3.58
3x25+3x50/3	6.21	39.3	41.8	2450	1125	0.78	0.23	0.37	135	3.58
3x35+3x25/3	7.8	42.7	45.2	2900	1575	0.55	0.27	0.34	172	5.01
3x35+3x50/3	7.8	42.7	45.2	2950	1575	0.55	0.27	0.34	172	5.01
3x50+3x25/3	9.56	46.5	49	3600	2250	0.39	0.31	0.32	216	7.15
3x50+3x50/3	9.56	46.5	49	3600	2250	0.39	0.31	0.32	216	7.15
3x70+3x35/3	11.06	51.2	53.7	4550	3150	0.27	0.35	0.31	265	10.01
3x70+3x50/3	11.06	51.2	53.7	4750	3150	0.27	0.35	0.31	265	10.01
3x95+3x50/3	12.6	54.5	58	5500	4275	0.21	0.38	0.29	319	13.59
3x120+3x70/3	14.8	59.2	62.7	6650	5400	0.16	0.44	0.28	371	17.16
3x150+3x95/3	15.95	63.5	67	7850	6750	0.13	0.46	0.28	428	21.45
3x185+3x95/3	17.7	67.2	70.7	9250	8325	0.11	0.5	0.27	488	26.46
3x240+3x120/3	20.2	74.4	77.9	11400	10800	0.08	0.56	0.26	575	34.32
3x300+3x150/3	22.68	79.7	83.2	13900	13500	0.06	0.62	0.25	662	42.9

(1) Nominal current carrying capacity for rubber cables laid on a surface, at 30°C ambient temperature (see also VDE 0298-4, Table 15).

Rated voltage 12/20 kV

Number of cores x cross section	Conductor diameter max. mm	Outer diameter min. mm	Outer diameter max. mm	Net weight approx. kg/km	Permissible tensile force max. N	Conductor resistance at 20°C max. Ω/km	Nom. operating capacitance μF/km	Inductance nom. mH/km	Current carrying capacity (1) A	Short Circuit Current (conductor) kA
3x25+3x25/3	6.21	42.1	44.6	2650	1125	0.78	0.21	0.38	135	3.58
3x25+3x50/3	6.21	42.1	44.6	2700	1125	0.78	0.21	0.38	135	3.58
3x35+3x25/3	7.8	45.5	48	3150	1575	0.55	0.25	0.35	172	5.01
3x35+3x50/3	7.8	45.5	48	3250	1575	0.55	0.25	0.35	172	5.01
3x50+3x25/3	9.56	50.7	53.2	4050	2250	0.39	0.28	0.33	216	7.15
3x50+3x50/3	9.56	50.7	53.2	4050	2250	0.39	0.28	0.33	216	7.15
3x70+3x35/3	11.06	54	56.5	4900	3150	0.27	0.31	0.32	265	10.01
3x70+3x50/3	11.06	54	56.5	5050	3150	0.27	0.31	0.32	265	10.01
3x95+3x50/3	12.6	57.3	60.8	5850	4275	0.21	0.34	0.3	319	13.59
3x120+3x70/3	14.8	63.8	67.3	7250	5400	0.16	0.39	0.29	371	17.16
3x150+3x95/3	15.95	66.3	69.8	8250	6750	0.13	0.41	0.28	428	21.45
3x185+3x95/3	17.7	70	73.5	9650	8325	0.11	0.45	0.28	488	26.46
3x240+3x120/3	20.2	77.2	80.7	11850	10800	0.08	0.5	0.27	575	34.32
3x300+3x150/3	22.68	82.5	86	14350	13500	0.06	0.55	0.26	662	42.9

(1) Nominal current carrying capacity for rubber cables laid on a surface, at 30°C ambient temperature (see also VDE 0298-4, Table 15).

Rated voltage 14/25 kV

Number of cores x cross section	Conductor diameter max. mm	Outer diameter min. mm	Outer diameter max. mm	Net weight approx. kg/km	Permissible tensile force max. N	Conductor resistance at 20°C max. Ω/km	Nom. operating capacitance μF/km	Inductance nom. mH/km	Current carrying capacity (1) A	Short Circuit Current (conductor) kA
3x25+3x25/3	6.21	45.8	48.3	2950	1125	0.78	0.18	0.4	135	3.58
3x25+3x50/3	6.21	45.8	48.3	3050	1125	0.78	0.18	0.4	135	3.58
3x35+3x25/3	7.8	50.6	53.1	3700	1575	0.55	0.21	0.37	172	5.01
3x35+3x50/3	7.8	50.6	53.1	3750	1575	0.55	0.21	0.37	172	5.01
3x50+3x25/3	9.56	54.4	56.9	4450	2250	0.39	0.24	0.35	216	7.15
3x50+3x50/3	9.56	54.4	56.9	4450	2250	0.39	0.24	0.35	216	7.15
3x70+3x35/3	11.06	57.6	60.1	5300	3150	0.27	0.27	0.33	265	10.01
3x70+3x50/3	11.06	57.6	60.1	5500	3150	0.27	0.27	0.33	265	10.01
3x95+3x50/3	12.6	62.7	66.2	6550	4275	0.21	0.29	0.32	319	13.59
3x120+3x70/3	14.8	67.4	70.9	7750	5400	0.16	0.33	0.3	371	17.16
3x150+3x95/3	15.95	69.9	73.4	8750	6750	0.13	0.35	0.3	428	21.45
3x185+3x95/3	17.7	75.5	79	10500	8325	0.11	0.38	0.29	488	26.46
3x240+3x120/3	20.2	80.8	84.3	12450	10800	0.08	0.42	0.28	575	34.32
3x300+3x150/3	22.68	88	91.5	15350	13500	0.06	0.46	0.27	662	42.9

(1) Nominal current carrying capacity for rubber cables laid on a surface, at 30°C ambient temperature (see also VDE 0298-4, Table 15).

Rated voltage 18/30 kV

Number of cores x cross section	Conductor diameter max. mm	Outer diameter min. mm	Outer diameter max. mm	Net weight approx. kg/km	Permissible tensile force max. N	Conductor resistance at 20°C max. Ω/km	Nom. operating capacitance μF/km	Inductance nom. mH/km	Current carrying capacity (1) A	Short Circuit Current (conductor) kA
3x25+3x25/3	6.21	50.5	53	3450	1125	0.78	0.16	0.42	135	3.58
3x25+3x50/3	6.21	50.5	53	3550	1125	0.78	0.16	0.42	135	3.58
3x35+3x25/3	7.8	53.9	56.4	4050	1575	0.55	0.19	0.39	172	5.01
3x35+3x50/3	7.8	53.9	56.4	4100	1575	0.55	0.19	0.39	172	5.01
3x50+3x25/3	9.56	57.7	60.2	4850	2250	0.39	0.21	0.37	216	7.15
3x50+3x50/3	9.56	57.7	60.2	4850	2250	0.39	0.21	0.37	216	7.15
3x70+3x35/3	11.06	62.7	65.2	5950	3150	0.27	0.23	0.35	265	10.01
3x70+3x50/3	11.06	62.7	65.2	6150	3150	0.27	0.23	0.35	265	10.01
3x95+3x50/3	12.6	66.1	69.6	7000	4275	0.21	0.25	0.33	319	13.59
3x120+3x70/3	14.8	70.8	74.3	8250	5400	0.16	0.28	0.32	371	17.16
3x150+3x95/3	15.95	75.1	78.6	9550	6750	0.13	0.3	0.31	428	21.45
3x185+3x95/3	17.7	78.8	82.3	11050	8325	0.11	0.32	0.3	488	26.46
3x240+3x120/3	20.2	86	89.5	13400	10800	0.08	0.36	0.29	575	34.32
3x300+3x150/3	22.68	91.3	94.8	16000	13500	0.06	0.39	0.28	662	42.9

(1) Nominal current carrying capacity for rubber cables laid on a surface, at 30°C ambient temperature (see also VDE 0298-4, Table 15).

Rated voltage 20/35 kV

Number of cores x cross section	Conductor diameter max. mm	Outer diameter min. mm	Outer diameter max. mm	Net weight approx. kg/km	Permissible tensile force max. N	Conductor resistance at 20°C max. Ω/km	Nom. operating capacitance μF/km	Inductance nom. mH/km	Current carrying capacity (1) A	Short Circuit Current (conductor) kA
3x25+3x25/3	6.21	54.7	57.2	3900	1125	0.78	0.15	0.44	135	3.58
3x35+3x25/3	7.8	58.1	60.6	4550	1575	0.55	0.17	0.41	172	5.01
3x50+3x25/3	9.56	63.7	66.2	5600	2250	0.39	0.19	0.38	216	7.15
3x50+3x50/3	9.56	63.7	66.2	5650	2250	0.39	0.19	0.38	216	7.15
3x70+3x35/3	11.06	66.9	69.4	6550	3150	0.27	0.21	0.36	265	10.01
3x70+3x50/3	11.06	66.9	69.4	6700	3150	0.27	0.21	0.36	265	10.01

(1) Nominal current carrying capacity for rubber cables laid on a surface, at 30°C ambient temperature (see also VDE 0298-4, Table 15).

Opencast Mining



MEDIUM VOLTAGE TRAILING CABLES

	TENAX SAS	PROTOLON(SB-SAM)	PROTOLON(SB-SAM) Screen
Application	Trailing & Reeling	Trailing	Trailing
Permissible tensile force	25N/mm ²	20N/mm ²	20N/mm ²
Cable Design	acc. to VDE	based on VDE	based on VDE
Sheath quality	5GM5+	5GM5	5GM5
Sheath abrasion against surface	++++	+++	+++
Reversed bending stability	+++	+++	++
Temperature range in fully flexible operation	-50°C to +60°C	-30°C to +60°C	-30°C to +60°C
Approvals	Fire Certificate, Gost K, Gost B	Fire Certificate, Gost K, Gost B	Fire Certificate, Gost K, Gost B

TENAX SAS

Power supply cable for trailing applications cold flexible version up to -50°C

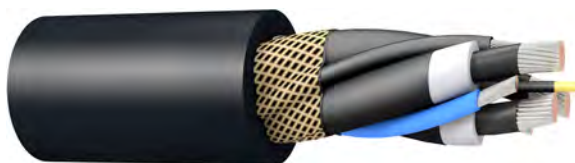

Application

As power supply cable to large mobile equipment in mines. Trailing cable for use with shovels and draglines in trailing and reeling applications. The outer sheath is extremely robust and tough against abrasion and tearing, fully flexible operation down to -50°C,

Global data

Brand	TENAX-SAS
Type designation	NTSCGEWOEU
Standard	DIN VDE 0250-813
Certifications / Approvals	Fire Certificate of Russian Federation GOST K GOST B

Design features

Conductor	Tinned copper, finely stranded (class 5), according to DIN VDE 0295
PE-Conductor	Tinned copper, finely stranded (class 5) with semi conductive special rubber compound
Insulation	Rubber, Compound type: EPR 3GI3
Electrical field control	Inner and outer layer of semiconductive rubber compound, cold strippable outer layer
Core arrangement	Cores laid up around conductive central cradle separator with aramid rope in the centre
Inner sheath	Rubber sheath, Special compound: 5GM3 (mechanical properties)
Pilot conductor	Tinned copper, finely stranded (class 5), EPR-Insulation
Outer sheath	Rubber, compound type: better 5GM5, acc. to DIN VDE 0207 part 21; Sheath color: Black

Electrical parameters

Rated voltage	3.6/6 kV	6/10 kV	8.7/15 kV	12/20 kV	14/25 kV	18/30 kV
Maximum permissible operating voltage AC	4.2/7.2 kV	6.9/12 kV	10.4/18 kV	13.9/24 kV	17.3/30 kV	20.8/36 kV
Maximum permissible operating voltage DC	5.4/10.8 kV	9/18 kV	13.5/27 kV	18/36 kV	22.5/45 kV	27/54 kV
AC test voltage	11 kV	17 kV	24 kV	29 kV	36 kV	43 kV

Chemical parameters

Resistance to fire	EN 60322-1-2, IEC 60322-1-2
Resistance to oil	EN 60811-404, IEC 60811-404
Weather resistance	Unrestricted use outdoors and indoors, resistant to ozone and moisture

Thermal parameters

Max. permissible temperature at conductor	90 °C
Max. short circuit temperature of the conductor	250 °C
Ambient temperature for fix installation min.	-50 °C
Ambient temperature for fix installation max.	80 °C
Ambient temp. in fully flex. operation min.	-50 °C
Ambient temp. in fully flex. operation max.	60 °C

Mechanical parameters

Max. tensile load of cable	25 N/mm ²
Bending radii min.	Acc. to DIN VDE 0298 part 3
Minimum distance with S-type directional changes	20 x D

Rated voltage 3.6/6 kV

Number of cores x cross section	Part number	Conductor diameter max. mm	Outer diameter min. mm	Outer diameter max. mm	Net weight approx. kg/km	Permissible tensile force max. N	Conductor resistance at 20°C max. Ω/km	Nom. operating capacitance μF/km	Inductance nom. mH/km	Current carrying capacity (1) A	Short Circuit Current (conductor) kA
3x35+3x25/3		6.2	44.4	47.9	2750	1575	0.565	0.23	0.36	162	5
3x35+2x16+16	20076465	7.5	47.2	50.7	3225	1575	0.565	0.26	0.34	162	5
3x50+3x25/3		9	50.3	54.8	3850	2250	0.393	0.29	0.32	202	7.2
3x70+3x35/3		10.6	55.6	60.1	4900	3150	0.277	0.33	0.31	250	10
3x95+3x50/3		12.6	59.9	64.4	5800	4275	0.21	0.37	0.29	301	13.6
3x120+3x70/3		14.8	66.5	71	7250	5400	0.164	0.42	0.28	352	17.2
3x150+3x70/3		16	68.9	73.4	8150	6750	0.132	0.45	0.27	404	21.5
3x185+3x95/3		17.7	72.7	77.2	9600	8325	0.108	0.48	0.27	461	26.5
3x240+3x120/3		20.3	80.1	84.6	12050	10800	0.0817	0.54	0.26	540	34.3

Rated voltage 6/10 kV

Number of cores x cross section	Part number	Conductor diameter max. mm	Outer diameter min. mm	Outer diameter max. mm	Net weight approx. kg/km	Permissible tensile force max. N	Conductor resistance at 20°C max. Ω/km	Nom. operating capacitance μF/km	Inductance nom. mH/km	Current carrying capacity (1) A	Short Circuit Current (conductor) kA
3x25+3x16/3		6.2	46.1	49.6	2925	1125	0.8	0.21	0.37	131	3.6
3x35+3x16/3		7.5	48.9	52.4	3375	1575	0.565	0.24	0.35	162	5
3x50+3x25/3		9	52	56.5	4025	2250	0.393	0.27	0.33	202	7.2
3x70+3x35/3		10.6	57.3	61.8	5100	3150	0.277	0.3	0.31	250	10
3x95+3x50/3		12.6	61.6	66.1	6025	4275	0.21	0.34	0.3	301	13.6
3x120+3x70/3		14.8	68.2	72.7	7475	5400	0.164	0.38	0.29	352	17.2
3x150+3x70/3		16	70.6	75.1	8375	6750	0.132	0.41	0.28	404	21.5
3x185+3x95/3		17.7	74.4	78.9	9850	8325	0.108	0.44	0.27	461	26.5
3x240+3x120/3		20.3	81.8	86.3	12325	10800	0.0817	0.49	0.26	540	34.3

Rated voltage 8.7/15 kV

Number of cores x cross section	Conductor diameter max. mm	Outer diameter min. mm	Outer diameter max. mm	Net weight approx. kg/km	Permissible tensile force max. N	Conductor resistance at 20°C max. Ω/km	Nom. operating capacitance μF/km	Inductance nom. mH/km	Current carrying capacity (1) A	Short Circuit Current (conductor) kA
3x25+3x16/3	6.2	50.8	55.3	3375	1125	0.8	0.18	0.4	139	3.6
3x35+3x16/3	7.5	55.4	59.9	4050	1575	0.565	0.2	0.37	172	5
3x50+3x25/3	9	58.5	63	4725	2250	0.393	0.22	0.35	215	7.2
3x70+3x35/3	10.6	62.1	66.6	5650	3150	0.277	0.25	0.33	265	10
3x95+3x50/3	12.6	68.2	72.7	6850	4275	0.21	0.28	0.32	319	13.6
3x120+3x70/3	14.8	72.9	77.4	8125	5400	0.164	0.32	0.3	371	17.2
3x150+3x70/3	16	75.4	79.9	9075	6750	0.132	0.33	0.3	428	21.5
3x185+3x95/3	17.7	80.9	85.4	10825	8325	0.108	0.36	0.29	488	26.5
3x240+3x120/3	20.3	86.5	91	13125	10800	0.0817	0.4	0.28	574	34.3

Rated voltage 12/20 kV

Number of cores x cross section	Conductor diameter max. mm	Outer diameter min. mm	Outer diameter max. mm	Net weight approx. kg/km	Permissible tensile force max. N	Conductor resistance at 20°C max. Ω/km	Nom. operating capacitance μF/km	Inductance nom. mH/km	Current carrying capacity (1) A	Short Circuit Current (conductor) kA
3x25+3x16/3	6.2	56.9	61.4	4000	1125	0.8	0.16	0.42	139	3.6
3x35+3x16/3	7.5	59.7	64.2	4525	1575	0.565	0.18	0.39	172	5
3x50+3x25/3	9	62.8	67.3	5250	2250	0.393	0.2	0.37	215	7.2
3x70+3x35/3	10.6	68.2	72.7	6425	3150	0.277	0.22	0.35	265	10
3x95+3x50/3	12.6	72.5	77	7450	4275	0.21	0.25	0.33	319	13.6
3x120+3x70/3	14.8	79	83.5	9000	5400	0.164	0.27	0.32	371	17.2
3x150+3x70/3	16	81.5	86	9975	6750	0.132	0.29	0.31	428	21.5
3x185+3x95/3	17.7	85.2	89.7	11525	8325	0.108	0.31	0.3	488	26.5
3x240+3x120/3	20.3	92.6	97.1	14175	10800	0.0817	0.35	0.29	574	34.3

Rated voltage 14/25 kV

Number of cores x cross section	Conductor diameter max. mm	Outer diameter min. mm	Outer diameter max. mm	Net weight approx. kg/km	Permissible tensile force max. N	Conductor resistance at 20°C max. Ω/km	Nom. operating capacitance μF/km	Inductance nom. mH/km	Current carrying capacity (1) A	Short Circuit Current (conductor) kA
3x25+3x16/3	6.2	62.5	67	4675	1125	0.8	0.14	0.44	139	3.6
3x35+3x16/3	7.5	67.1	71.6	5450	1575	0.565	0.16	0.42	172	5
3x50+3x25/3	9	70.2	74.7	6200	2250	0.393	0.17	0.39	215	7.2
3x70+3x35/3	10.6	73.8	78.3	7225	3150	0.277	0.19	0.37	265	10
3x95+3x50/3	12.6	79.9	84.4	8550	4275	0.21	0.21	0.35	319	13.6
3x120+3x70/3	14.8	84.6	89.1	9925	5400	0.164	0.24	0.34	371	17.2
3x150+3x70/3	16	87.1	91.6	10925	6750	0.132	0.25	0.33	428	21.5
3x185+3x95/3	17.7	92.6	97.1	12800	8325	0.108	0.27	0.32	488	26.5
3x240+3x120/3	20.3	98.2	102.7	15225	10800	0.0817	0.3	0.3	574	34.3

Rated voltage 18/30 kV

Number of cores x cross section	Conductor diameter max. mm	Outer diameter min. mm	Outer diameter max. mm	Net weight approx. kg/km	Permissible tensile force max. N	Conductor resistance at 20°C max. Ω/km	Nom. operating capacitance μF/km	Inductance nom. mH/km	Current carrying capacity (1) A	Short Circuit Current (conductor) kA
3x25+3x16/3	6.2	69.5	74	5575	1125	0.8	0.13	0.46	139	3.6
3x35+3x16/3	7.5	72.3	76.8	6175	1575	0.565	0.14	0.44	172	5
3x50+3x25/3	9	75.4	79.9	6950	2250	0.393	0.16	0.41	215	7.2
3x70+3x35/3	10.6	80.7	85.2	8275	3150	0.277	0.17	0.39	265	10
3x95+3x50/3	12.6	85	89.5	9400	4275	0.21	0.19	0.37	319	13.6
3x120+3x70/3	14.8	91.6	96.1	11100	5400	0.164	0.21	0.35	371	17.2
3x150+3x70/3	16	94	98.5	12125	6750	0.132	0.22	0.34	428	21.5
3x185+3x95/3	17.7	97.8	102.3	13775	8325	0.108	0.24	0.33	488	26.5
3x240+3x120/3	20.3	103.4	107.9	16250	10800	0.0817	0.27	0.32	574	34.3

PROTOLON (SB-SAM) Flexible trailing cable



Application

As power supply or connection cables for large material handling machines, e.g. excavators in opencast mines subject to extremely high mechanical stresses in which abrasion and chaffing stresses are to be expected in trailing operation.

Global data

Brand	PROTOLON(SB-SAM)
Type designation	(N)TSCGEWOU
Standard	Based on DIN VDE 0250-813
Certifications / Approvals	MSHA P-189-4 Fire Certificate of Russian Federation GOST K GOST B

Notes on installation

Notes on installation	Suitable material sets for self-assembly or termination at manufacturer's factory workshop.
-----------------------	---

Design features

Conductor	Electrolytic copper, not tinned, finely stranded (class 5)
PE-Conductor	Electrolytic copper, not tinned, very finely stranded (class FS)
Insulation	PROTOLON, Basic material: EPR, Compound type: Special compound, better 3GI3
Electrical field control	Inner and outer layer of semiconductive rubber compound
Core identification	Natural coloring with black semiconductive rubber on which white digits 1 to 3 are printed
Core arrangement	Three main conductors laid-up, with protective-earth conductor and pilot core in the outer interstices
Pilot conductor	EPR insulated copper conductor (class FS), Color: Yellow
Reinforcement	Extremely tear-resistant reinforcing tape, which prevents sheath movement
Sheath system	Complete sheath (inner and outer sheath) of special extremely abrasion-resistant and tearproof chloroprene rubber compound, inner and outer sheath inseparably bonded, compound, Type: 5GM5 Standard Sheath Color: Black (other colors available upon request)

Electrical parameters

Rated voltage	3.6/6 kV	6/10 kV	8.7/15 kV	12/20 kV	14/25 kV	18/30 kV
Maximum permissible operating voltage AC	4.2/7.2 kV	6.9/12 kV	10.4/18 kV	13.9/24 kV	17.3/30 kV	20.8/36 kV
Maximum permissible operating voltage DC	5.4/10.8 kV	9/18 kV	13.5/27 kV	18/36 kV	22.5/45 kV	27/54 kV
AC test voltage	11 kV	17 kV	24 kV	29 kV	36 kV	43 kV

Chemical parameters

Resistance to fire	EN 60332-1-2, IEC 60332-1-2
Resistance to oil	Given according to EN 60811-404, IEC 60811-404
Weather resistance	Unrestricted use outdoors and indoors, resistant to ozone, UV and moisture

Thermal parameters

Max. permissible temperature at conductor	90 °C
Max. short circuit temperature of the conductor	250 °C
Ambient temperature for fix installation min.	-40 °C
Ambient temperature for fix installation max.	80 °C
Ambient temp. in fully flex. operation min.	-30 °C
Ambient temp. in fully flex. operation max.	60 °C

Mechanical parameters

Max. tensile load of cable	20 N/mm ²
Torsional stress	100 °/m
Bending radii min.	Acc. to DIN VDE 0298 part 3

Rated voltage 3.6/6 kV

Number of cores x cross section	Conductor diameter max. mm	Outer diameter min. mm	Outer diameter max. mm	Net weight approx. kg/km	Permissible tensile force max. N	Conductor resistance at 20°C max. Ω/km	Nom. operating capacitance μF/km	Inductance nom. mH/km	Current carrying capacity (1) A	Short Circuit Current (conductor) kA
3x25 + 2x25/2 + 1x10ST	6.5	35.5	42.5	2500	1125	0.78	0.35	0.32	131	3.58
3x35 + 2x25/2 + 1x10ST	7.6	41.9	44.9	2800	1575	0.554	0.39	0.31	162	5.01
3x50 + 2x25/2 + 1x10ST	9.1	42.7	45.7	3300	2250	0.386	0.45	0.29	202	7.15
3x70 + 2x35/2 + 1x10ST	10.9	46.5	49.5	4300	3150	0.272	0.52	0.28	250	10.01
3x95 + 2x50/2 + 1x10ST	12.7	52.9	56.9	5600	4275	0.206	0.58	0.27	301	13.6
3x120 + 2x70/2 + 1x10ST	14.4	56.5	60.5	6750	5400	0.161	0.65	0.26	352	17.16
3x150 + 2x70/2 + 1x10ST	16.2	63	67	8100	6750	0.129	0.71	0.25	404	21.45
3x185 + 2x95/2 + 1x10ST	17.8	66.4	70.4	9400	8352	0.106	0.77	0.25	462	26.46
3x240 + 2x120/2 + 1x10ST	20.6	72.3	76.3	11700	10800	0.08	0.88	0.24	540	34.32

(1) Ambient temperature 30°C

Rated voltage 6/10 kV

Number of cores x cross section	Conductor diameter max. mm	Outer diameter min. mm	Outer diameter max. mm	Net weight approx. kg/km	Permissible tensile force max. N	Conductor resistance at 20°C max. Ω/km	Nom. operating capacitance μF/km	Inductance nom. mH/km	Current carrying capacity (1) A	Short Circuit Current (conductor) kA
3x25 + 2x25/2 + 1x10ST	6.5	40.8	43.8	2700	1125	0.78	0.3	0.34	131	3.58
3x35 + 2x25/2 + 1x10ST	7.6	41.1	44.1	2900	1575	0.554	0.33	0.32	162	5.01
3x50 + 2x25/2 + 1x10ST	9.1	45.3	48.3	3600	2250	0.386	0.38	0.31	202	7.15
3x70 + 2x35/2 + 1x10ST	10.9	48.2	51.2	4400	3150	0.272	0.43	0.29	250	10.01
3x95 + 2x50/2 + 1x10ST	12.7	54.2	58.2	5700	4275	0.206	0.48	0.28	301	13.6
3x120 + 2x70/2 + 1x10ST	14.4	57.8	61.8	6900	5400	0.161	0.54	0.27	352	17.16
3x150 + 2x70/2 + 1x10ST	16.2	64.2	68.2	8300	6750	0.129	0.59	0.26	404	21.45
3x185 + 2x95/2 + 1x10ST	17.8	67.6	71.6	9600	8352	0.106	0.64	0.26	462	26.46
3x240 + 2x120/2 + 1x10ST	20.6	72.3	76.3	11800	10800	0.08	0.72	0.25	540	34.32

(1) Ambient temperature 30°C

Rated voltage 8.7/15 kV

Number of cores x cross section	Part number	Conductor diameter max. mm	Outer diameter min. mm	Outer diameter max. mm	Net weight approx. kg/km	Permissible tensile force max. N	Conductor resistance at 20°C max. Ω/km	Nom. operating capacitance μF/km	Inductance nom. mH/km	Current carrying capacity (1) A	Short Circuit Current (conductor) kA
3x25 + 2x25/2 + 1x10ST		6.5	41.9	44.9	2600	1125	0.78	0.22	0.37	139	3.58
3x35 + 2x25/2 + 1x10ST	20069641	7.6	45.5	48.5	3300	1575	0.554	0.25	0.35	172	5.01
3x50 + 2x25/2 + 1x10ST		9.1	47.4	50.4	3700	2250	0.386	0.28	0.33	215	7.15
3x70 + 2x35/2 + 1x10ST	20069640	10.9	53.7	57.7	5170	3150	0.272	0.32	0.31	265	10.01
3x95 + 2x50/2 + 1x10ST		12.7	57.6	61.6	6150	4275	0.206	0.35	0.3	319	13.6
3x120 + 2x70/2 + 1x10ST	20088941	14.4	63	67	7590	5400	0.161	0.39	0.29	371	17.16
3x150 + 2x70/2 + 1x10ST	20088942	16.2	66.8	70.8	8700	6750	0.129	0.43	0.28	428	21.45
3x185 + 2x95/2 + 1x10ST		17.8	71	75	10100	8352	0.106	0.46	0.27	488	26.46
3x240 + 2x120/2 + 1x10ST		20.6	78.3	83.3	12800	10800	0.08	0.52	0.27	574	34.32

(1) Ambient temperature 30°C

Rated voltage 12/20 kV

Number of cores x cross section	Conductor diameter max. mm	Outer diameter min. mm	Outer diameter max. mm	Net weight approx. kg/km	Permissible tensile force max. N	Conductor resistance at 20°C max. Ω/km	Nom. operating capacitance μF/km	Inductance nom. mH/km	Current carrying capacity (1) A	Short Circuit Current (conductor) kA
3x25 + 2x25/2 + 1x10ST	6.5	44.9	47.9	3000	1125	0.78	0.22	0.37	139	3.58
3x35 + 2x25/2 + 1x10ST	7.6	47.2	50.2	3500	1575	0.554	0.24	0.35	172	5.01
3x50 + 2x25/2 + 1x10ST	9.1	51.7	55.7	4350	2250	0.386	0.27	0.33	215	7.15
3x70 + 2x35/2 + 1x10ST	10.9	55.5	59.5	5400	3150	0.272	0.31	0.32	265	10.01
3x95 + 2x50/2 + 1x10ST	12.7	60.5	64.5	6500	4275	0.206	0.35	0.3	319	13.6
3x120 + 2x70/2 + 1x10ST	14.4	65.9	69.9	8000	5400	0.161	0.38	0.29	371	17.16
3x150 + 2x70/2 + 1x10ST	16.2	70.6	74.6	9200	6750	0.129	0.42	0.28	428	21.45
3x185 + 2x95/2 + 1x10ST	17.8	75.8	79.8	10850	8352	0.106	0.45	0.28	488	26.46
3x240 + 2x120/2 + 1x10ST	20.6	81.2	86.2	13300	10800	0.08	0.51	0.27	574	34.32

(1) Ambient temperature 30°C

Rated voltage 14/25 kV

Number of cores x cross section	Conductor diameter max. mm	Outer diameter min. mm	Outer diameter max. mm	Net weight approx. kg/km	Permissible tensile force max. N	Conductor resistance at 20°C max. Ω/km	Nom. operating capacitance μF/km	Inductance nom. mH/km	Current carrying capacity (1) A	Short Circuit Current (conductor) kA
3x25 + 2x25/2 + 1x10ST	6.5	48.2	52.2	3500	1125	0.78	0.19	0.39	139	3.58
3x35 + 2x25/2 + 1x10ST	7.6	52.3	56.3	4100	1575	0.554	0.21	0.37	172	5.01
3x50 + 2x25/2 + 1x10ST	9.1	55.5	59.5	4800	2250	0.386	0.23	0.35	215	7.15
3x70 + 2x35/2 + 1x10ST	10.9	59.3	63.3	5800	3150	0.272	0.26	0.33	265	10.01
3x95 + 2x50/2 + 1x10ST	12.7	66.2	70.2	7300	4275	0.206	0.29	0.32	319	13.6
3x120 + 2x70/2 + 1x10ST	14.4	69.8	73.8	8600	5400	0.161	0.32	0.31	371	17.16
3x150 + 2x70/2 + 1x10ST	16.2	76.2	80.2	10100	6750	0.129	0.35	0.3	428	21.45
3x185 + 2x95/2 + 1x10ST	17.8	79.1	84.1	11600	8352	0.106	0.38	0.29	488	26.46
3x240 + 2x120/2 + 1x10ST	20.6	86.8	91.8	14200	10800	0.08	0.42	0.28	574	34.32

(1) Ambient temperature 30°C

Rated voltage 18/30 kV

Number of cores x cross section	Conductor diameter max. mm	Outer diameter min. mm	Outer diameter max. mm	Net weight approx. kg/km	Permissible tensile force max. N	Conductor resistance at 20°C max. Ω/km	Nom. operating capacitance μF/km	Inductance nom. mH/km	Current carrying capacity (1) A	Short Circuit Current (conductor) kA
3x25 + 2x25/2 + 1x10ST	6.5	53.3	57.3	4000	1125	0.78	0.17	0.41	139	3.58
3x35 + 2x25/2 + 1x10ST	7.6	55.7	59.7	4600	1575	0.554	0.18	0.39	172	5.01
3x50 + 2x25/2 + 1x10ST	9.1	58.9	62.9	5300	2250	0.386	0.2	0.37	215	7.15
3x70 + 2x35/2 + 1x10ST	10.9	64.5	68.5	6200	3150	0.272	0.23	0.35	265	10.01
3x95 + 2x50/2 + 1x10ST	12.7	69.5	73.5	8000	4275	0.206	0.25	0.33	319	13.6
3x120 + 2x70/2 + 1x10ST	14.4	74.9	78.9	9200	5400	0.161	0.28	0.32	371	17.16
3x150 + 2x70/2 + 1x10ST	16.2	79.1	84.1	10900	6750	0.129	0.3	0.31	428	21.45
3x185 + 2x95/2 + 1x10ST	17.8	82.5	87.5	12200	8352	0.106	0.32	0.3	488	26.46
3x240 + 2x120/2 + 1x10ST	20.6	90.2	95.2	15000	10800	0.08	0.36	0.29	574	34.32

(1) Ambient temperature 30°C

PROTOLON (SB-SAM) Screen

Flexible trailing cable with copper core shield



Application

As power supply or connection cables for large material handling machines, e.g. excavators in open-cast mines subject to extremely high mechanical stresses in which abrasion and chaffing stresses are to be expected in trailing operation.

Global data

Brand	PROTOLON(SB-SAM)
Type designation	(N)TSCGECEW0EU
Standard	Based on DIN VDE 0250-813
Certifications / Approvals	MSHA P-189-4 Fire Certificate of Russian Federation GOST K GOST B

Notes on installation

Notes on installation Suitable material sets for self-assembly or termination at manufacturer's factory workshop.

Design features

Conductor	Electrolytic copper, not tinned, finely stranded (class 5)
PE-Conductor	Electrolytic copper, not tinned, very finely stranded (class FS)
Insulation	PROTOLON, Basic material: EPR, Compound type: Special compound, better 3GI3
Electrical field control	Inner and outer layer of semiconductive rubber compound and metallic concentric screen on each core
Core identification	Natural coloring with black semiconductive rubber on which white digits 1 to 3 are printed
Core arrangement	Three main conductors laid-up, with protective-earth conductor and pilot core in the outer interstices
Pilot conductor	EPR insulated Copper conductor (class FS), Color: Yellow
Reinforcement	Extremely tear-resistant reinforcing tape which prevents sheath movement
Sheath system	Complete sheath (inner and outer sheath) of special extremely abrasion-resistant and tearproof chloroprene rubber compound, inner and outer sheath inseparably bonded Compound type: 5GM5 Standard Sheath Color: Black (other colors available upon request)

Electrical parameters

Rated voltage	3.6/6 kV	6/10 kV	8.7/15 kV	12/20 kV	14/25 kV	18/30 kV
Maximum permissible operating voltage AC	4.2/7.2 kV	6.9/12 kV	10.4/18 kV	13.9/24 kV	17.3/30 kV	20.8/36 kV
Maximum permissible operating voltage DC	5.4/10.8 kV	9/18 kV	13.5/27 kV	18/36 kV	22.5/45 kV	27/54 kV
AC test voltage	11 kV	17 kV	24 kV	29 kV	36 kV	43 kV

Chemical parameters

Resistance to fire	EN 60332-1-2, IEC 60332-1-2
Resistance to oil	Given according to EN 60811-404, IEC 60811-404
Weather resistance	Unrestricted use outdoors and indoors, resistant to ozone, UV and moisture

Thermal parameters

Max. permissible temperature at conductor	90 °C
Max. short circuit temperature of the conductor	250 °C
Ambient temperature for fix installation min.	-40 °C
Ambient temperature for fix installation max.	80 °C
Ambient temp. in fully flex. operation min.	-30 °C
Ambient temp. in fully flex. operation max.	60 °C

Mechanical parameters

Max. tensile load of cable	20 N/mm ²
Torsional stress	25 °/m
Bending radii min.	Acc. to DIN VDE 0298 part 3

Rated voltage 3.6/6 kV

Number of cores x cross section	Conductor diameter max. mm	Outer diameter min. mm	Outer diameter max. mm	Net weight approx. kg/km	Permissible tensile force max. N	Conductor resistance at 20°C max. Ω/km	Nom. operating capacitance μF/km	Inductance nom. mH/km	Current carrying capacity (1) A	Short Circuit Current (conductor) kA
3x25 + 2x25/2 + 1x10ST	6.5	41.6	44.6	2860	1125	0.78	0.37	0.35	131	3.58
3x35 + 2x25/2 + 1x10ST	7.6	44	47	3290	1575	0.554	0.43	0.32	162	5.01
3x50 + 2x25/2 + 1x10ST	9.1	47.1	50.1	3950	2250	0.386	0.49	0.28	202	7.15
3x70 + 2x35/2 + 1x10ST	10.9	52.3	56.3	5100	3150	0.272	0.55	0.27	250	10.01
3x95 + 2x50/2 + 1x10ST	12.7	56.1	60.1	6130	4275	0.206	0.63	0.26	301	13.6
3x120 + 2x70/2 + 1x10ST	14.4	59.7	63.7	7360	5400	0.161	0.7	0.25	352	17.16
3x150 + 2x70/2 + 1x10ST	16.2	66.3	70.3	8770	6750	0.129	0.76	0.25	404	21.45
3x185 + 2x95/2 + 1x10ST	17.8	69.7	73.7	10140	8352	0.106	0.82	0.24	462	26.46
3x240 + 2x120/2 + 1x10ST	20.6	77.4	81.4	12790	10800	0.08	0.93	0.24	540	34.32

(1) Ambient temperature 30°C

Rated voltage 6/10 kV

Number of cores x cross section	Conductor diameter max. mm	Outer diameter min. mm	Outer diameter max. mm	Net weight approx. kg/km	Permissible tensile force max. N	Conductor resistance at 20°C max. Ω/km	Nom. operating capacitance μF/km	Inductance nom. mH/km	Current carrying capacity (1) A	Short Circuit Current (conductor) kA
3x25 + 2x25/2 + 1x10ST	6.5	42.6	45.6	2970	1125	0.78	0.33	0.35	131	3.58
3x35 + 2x25/2 + 1x10ST	7.6	45.5	48.5	3460	1575	0.554	0.38	0.32	162	5.01
3x50 + 2x25/2 + 1x10ST	9.1	48.4	51.4	4080	2250	0.386	0.43	0.28	202	7.15
3x70 + 2x35/2 + 1x10ST	10.9	53.5	57.5	5240	3150	0.272	0.49	0.27	250	10.01
3x95 + 2x50/2 + 1x10ST	12.7	57.4	61.4	6320	4275	0.206	0.56	0.26	301	13.6
3x120 + 2x70/2 + 1x10ST	14.4	62.8	66.8	7770	5400	0.161	0.62	0.25	352	17.16
3x150 + 2x70/2 + 1x10ST	16.2	67.6	71.6	8990	6750	0.129	0.67	0.25	404	21.45
3x185 + 2x95/2 + 1x10ST	17.8	71	75	10330	8352	0.106	0.73	0.24	462	26.46
3x240 + 2x120/2 + 1x10ST	20.6	78.7	82.7	12990	10800	0.08	0.82	0.24	540	34.32

(1) Ambient temperature 30°C

Rated voltage 8.7/15 kV

Number of cores x cross section	Conductor diameter max. mm	Outer diameter min. mm	Outer diameter max. mm	Net weight approx. kg/km	Permissible tensile force max. N	Conductor resistance at 20°C max. Ω/km	Nom. operating capacitance μF/km	Inductance nom. mH/km	Current carrying capacity (1) A	Short Circuit Current (conductor) kA
3x25 + 2x25/2 + 1x10ST	6.5	46.3	49.3	3330	1125	0.78	0.26	0.36	139	3.58
3x35 + 2x25/2 + 1x10ST	7.6	48.1	52.1	3770	1575	0.554	0.31	0.33	172	5.01
3x50 + 2x25/2 + 1x10ST	9.1	53.1	57.1	4690	2250	0.386	0.35	0.31	215	7.15
3x70 + 2x35/2 + 1x10ST	10.9	57	61	5640	3150	0.272	0.38	0.3	265	10.01
3x95 + 2x50/2 + 1x10ST	12.7	60.8	64.8	6750	4275	0.206	0.43	0.28	319	13.6
3x120 + 2x70/2 + 1x10ST	14.4	66.1	70.1	8220	5400	0.161	0.48	0.27	371	17.16
3x150 + 2x70/2 + 1x10ST	16.2	71	75	9490	6750	0.129	0.53	0.27	428	21.45
3x185 + 2x95/2 + 1x10ST	17.8	76.1	80.1	11180	8352	0.106	0.57	0.26	488	26.46
3x240 + 2x120/2 + 1x10ST	20.6	82.1	86.1	13560	10800	0.08	0.64	0.25	574	34.32

(1) Ambient temperature 30°C

Rated voltage 12/20 kV

Number of cores x cross section	Conductor diameter max. mm	Outer diameter min. mm	Outer diameter max. mm	Net weight approx. kg/km	Permissible tensile force max. N	Conductor resistance at 20°C max. Ω/km	Nom. operating capacitance μF/km	Inductance nom. mH/km	Current carrying capacity (1) A	Short Circuit Current (conductor) kA
3x25 + 2x25/2 + 1x10ST	6.5	48.8	52.8	3620	1125	0.78	0.23	0.36	139	3.58
3x35 + 2x25/2 + 1x10ST	7.6	52.9	56.9	4350	1575	0.554	0.26	0.34	172	5.01
3x50 + 2x25/2 + 1x10ST	9.1	56.1	60.1	5020	2250	0.386	0.3	0.32	215	7.15
3x70 + 2x35/2 + 1x10ST	10.9	59.9	63.9	6040	3150	0.272	0.33	0.31	265	10.01
3x95 + 2x50/2 + 1x10ST	12.7	65.5	69.5	7390	4275	0.206	0.37	0.3	319	13.6
3x120 + 2x70/2 + 1x10ST	14.4	69	73	8680	5400	0.161	0.41	0.29	371	17.16
3x150 + 2x70/2 + 1x10ST	16.2	75.7	79.7	10280	6750	0.129	0.44	0.28	428	21.45
3x185 + 2x95/2 + 1x10ST	17.8	79.2	83.2	11670	8352	0.106	0.48	0.27	488	26.46
3x240 + 2x120/2 + 1x10ST	20.6	86.4	91.4	14560	10800	0.08	0.54	0.26	574	34.32

(1) Ambient temperature 30°C

Rated voltage 14/25 kV

Number of cores x cross section	Conductor diameter max. mm	Outer diameter min. mm	Outer diameter max. mm	Net weight approx. kg/km	Permissible tensile force max. N	Conductor resistance at 20°C max. Ω/km	Nom. operating capacitance μF/km	Inductance nom. mH/km	Current carrying capacity (1) A	Short Circuit Current (conductor) kA
3x25 + 2x25/2 + 1x10ST	6.5	54.4	58.4	4290	1125	0.78	0.2	0.38	139	3.58
3x35 + 2x25/2 + 1x10ST	7.6	56.8	60.8	4780	1575	0.554	0.22	0.36	172	5.01
3x50 + 2x25/2 + 1x10ST	9.1	59.9	63.9	5540	2250	0.386	0.26	0.34	215	7.15
3x70 + 2x35/2 + 1x10ST	10.9	65.5	69.5	6800	3150	0.272	0.28	0.32	265	10.01
3x95 + 2x50/2 + 1x10ST	12.7	69.3	73.3	7980	4275	0.206	0.31	0.31	319	13.6
3x120 + 2x70/2 + 1x10ST	14.4	74.7	78.7	9540	5400	0.161	0.35	0.3	371	17.16
3x150 + 2x70/2 + 1x10ST	16.2	79.6	83.6	10900	6750	0.129	0.37	0.29	428	21.45
3x185 + 2x95/2 + 1x10ST	17.8	83	87	12450	8352	0.106	0.4	0.28	488	26.46
3x240 + 2x120/2 + 1x10ST	20.6	90.2	95.2	15250	10800	0.08	0.45	0.27	574	34.32

(1) Ambient temperature 30°C

Rated voltage 18/30 kV

Number of cores x cross section	Conductor diameter max. mm	Outer diameter min. mm	Outer diameter max. mm	Net weight approx. kg/km	Permissible tensile force max. N	Conductor resistance at 20°C max. Ω/km	Nom. operating capacitance μF/km	Inductance nom. mH/km	Current carrying capacity (1) A	Short Circuit Current (conductor) kA
3x25 + 2x25/2 + 1x10ST	6.5	56.5	60.5	4360	1125	0.78	0.17	0.41	139	3.58
3x35 + 2x25/2 + 1x10ST	7.6	58.8	62.8	5090	1575	0.554	0.18	0.39	172	5.01
3x50 + 2x25/2 + 1x10ST	9.1	63.8	67.8	5920	2250	0.386	0.2	0.37	215	7.15
3x70 + 2x35/2 + 1x10ST	10.9	67.6	71.6	6950	3150	0.272	0.23	0.35	265	10.01
3x95 + 2x50/2 + 1x10ST	12.7	74.5	78.5	8880	4275	0.206	0.25	0.33	319	13.6
3x120 + 2x70/2 + 1x10ST	14.4	78.1	82.1	10210	5400	0.161	0.28	0.32	371	17.16
3x150 + 2x70/2 + 1x10ST	16.2	82.7	87.7	12040	6750	0.129	0.3	0.31	428	21.45
3x185 + 2x95/2 + 1x10ST	17.8	87.9	92.9	13470	8352	0.106	0.32	0.3	488	26.46
3x240 + 2x120/2 + 1x10ST	20.6	93.9	98.9	16400	10800	0.08	0.36	0.29	574	34.32

(1) Ambient temperature 30°C

Opencast Mining



MEDIUM VOLTAGE DREDGE CABLES

	PROTOLON(ST).../3E	PROTOLON(ST)	PROTOLON(M)-F
Permissible tensile force	15N/mm ²	15N/mm ²	15N/mm ²
Cable Design	acc. to VDE	acc. to VDE	based on VDE
Protection conductor	Semiconductive & Metallic screen	Semiconductive screen	Semiconductive screen
Stability against torsion	+/- 25°C	+/- 100°C	+/- 100°C
Sheath quality	5GM3	5GM3	5GM3
Water compatibility acc. to VDE 0282 part 16	excellent	excellent	very good
Stability against water penetration	+++	+++	++
Approvals	Fire Certificate, Gost K, Gost B MSHA P-189-4	Fire Certificate, Gost K, Gost B MSHA P-189-4	Fire Certificate, Gost K, Gost B

PROTOLON (ST) .../3E

Medium voltage flexible cables for use in water with copper core shield



Application

Power supply cable for use in water, e.g. for connection to dredgers, floating docks, pumps, etc., in applications where high mechanical stresses are to be expected. Also suitable for use in sewage, salt water and brackish water at water depths of up to 500 m. This screened cable design is suitable for the use with dredging equipment acc. VDE 0168.

Global data

Brand	PROTOLON(ST)
Type designation	NTSCGEWUEU.../3E
Standard	DIN VDE 0250-813
Certifications / Approvals	MSHA P-189-4 Fire Certificate of Russian Federation GOST K GOST B

Notes on installation

Notes on installation Suitable material sets for self-assembly or termination at manufacturer's factory workshop.

Design features

Conductor	Electrolytic copper, tinned, finely stranded (class 5)
Insulation	Basic material EPR, Compound type: 3GI3
Electrical field control	Inner and outer layer of semiconductive rubber compound and metallic concentric screen on each core
Core identification	Natural coloring with black semiconductive rubber
Core arrangement	Three main conductor laid-up with individual concentric protective-earth conductors distributed over the insulation of the three main cores
Inner sheath	EPR inner sheath with special characteristics with respect to water proofing and prevention of formation of water bubbles, Compound type: GM1B
Outer sheath	Basic material: synthetic elastomer compound e.g. CM (particularly water-proof), Compound type: 5GM3, Color: Red

Electrical parameters

Rated voltage	1.8/3 kV	3.6/6 kV	6/10 kV	8.7/15 kV	12/20 kV	14/25 kV	18/30 kV
Maximum permissible operating voltage AC	2.1/3.6 kV	4.2/7.2 kV	6.9/12 kV	10.4/18 kV	13.9/24 kV	17.3/30 kV	20.8/36 kV
Maximum permissible operating voltage DC	2.7/5.4 kV	5.4/10.8 kV	9/18 kV	13.5/27 kV	18/36 kV	22.5/45 kV	27/54 kV
AC test voltage	6 kV	11 kV	17 kV	24 kV	29 kV	36 kV	43 kV

Chemical parameters

Resistance to fire	EN 60332-1-2; IEC 60332-1-2
Resistance to oil	EN 60811-404, IEC 60811-404
Weather resistance	Unrestricted use outdoors and indoors, resistant to ozone, UV and moisture
Water resistance	EN50525-2-21

Thermal parameters

Max. permissible temperature at conductor	90 °C
Max. short circuit temperature of the conductor	250 °C
Ambient temperature for fix installation min.	-40 °C
Ambient temperature for fix installation max.	80 °C
Ambient temp. in fully flex. operation min.	-25 °C
Ambient temp. in fully flex. operation max.	60 °C

Mechanical parameters

Max. tensile load of cable	15 N/mm ²
Tensile load on the conductor max .	15 N/mm ²
Torsional stress	25 °/m
Bending radii min.	Acc. to DIN VDE 0298 part 3

Rated voltage 1.8/3 kV

Number of cores x cross section	Part number	Conductor diameter max. mm	Outer diameter min. mm	Outer diameter max. mm	Net weight approx. kg/km	Permissible tensile force max. N	Conductor resistance at 20°C max. Ω/km	Nom. operating capacitance μF/km	Inductance nom. mH/km	Current carrying capacity (1) A	Short Circuit Current (conductor) kA
3x 25+3x25/3E		6.4	37.5	40.5	2400	1125	0.795	0.33	0.33	131	3.58
3x 35+3x25/3E		7.6	40.9	43.9	3000	1575	0.565	0.38	0.31	162	5.01
3x 50+3x25/3E		9	45.4	48.4	3600	2250	0.393	0.43	0.3	202	7.15
3x 70+3x35/3E		10.9	50.8	54.8	4800	3150	0.277	0.5	0.28	250	10.01
3x 95+3x50/3E		12.6	57.1	61.1	6200	4275	0.21	0.52	0.27	301	13.53
3x120+3x70/3E	20008063	14.1	59.7	63.7	7290	5400	0.164	0.56	0.27	352	17.16
3x150+3x70/3E		16	67.6	71.6	8700	6750	0.132	0.63	0.26	404	21.45
3x185+3x95/3E		17.8	71.5	75.5	10200	8325	0.108	0.69	0.25	461	26.46

Rated voltage 3.6/6 kV

Number of cores x cross section	Part number	Conductor diameter max. mm	Outer diameter min. mm	Outer diameter max. mm	Net weight approx. kg/km	Permissible tensile force max. N	Conductor resistance at 20°C max. Ω/km	Nom. operating capacitance μF/km	Inductance nom. mH/km	Current carrying capacity (1) A	Short Circuit Current (conductor) kA
3x 25+3x25/3E		6.4	42.4	45.4	2800	1125	0.795	0.26	0.35	131	3.58
3x 35+3x25/3E	20004510	7.6	44.3	47.3	3260	1575	0.565	0.29	0.33	162	5.01
3x 50+3x25/3E	20004511	9	48.1	51.1	4000	2250	0.393	0.33	0.32	202	7.15
3x 70+3x35/3E	20004512	10.9	54.3	58.3	5200	3150	0.277	0.38	0.3	250	10.01
3x 95+3x50/3E		12.6	59.7	63.7	6400	4275	0.21	0.43	0.29	301	13.53
3x120+3x70/3E	20061120	14.1	64.1	68.1	7950	5400	0.164	0.47	0.28	352	17.16
3x150+3x70/3E	20160411	16	69.9	73.9	9200	6750	0.132	0.52	0.27	404	21.45
3x185+3x95/3E		17.8	75.8	79.8	11000	8325	0.108	0.56	0.26	461	26.46

Rated voltage 6/10 kV

Number of cores x cross section	Part number	Conductor diameter max. mm	Outer diameter min. mm	Outer diameter max. mm	Net weight approx. kg/km	Permissible tensile force max. N	Conductor resistance at 20°C max. Ω/km	Nom. operating capacitance μF/km	Inductance nom. mH/km	Current carrying capacity (1) A	Short Circuit Current (conductor) kA
3x 25+3x25/3E		6.4	44.1	47.1	3100	1125	0.795	0.24	0.36	131	3.58
3x 35+3x25/3E		7.6	46.7	49.7	3500	1575	0.565	0.27	0.34	162	5.01
3x 50+3x25/3E	20004597	9	51.9	55.9	4450	2250	0.393	0.3	0.32	202	7.15
3x 70+3x35/3E	20004598	10.9	57.3	61.3	5580	3150	0.277	0.34	0.31	250	10.01
3x 95+3x50/3E	20035932	12.6	63.2	67.2	6960	4275	0.21	0.38	0.29	301	13.53
3x120+3x70/3E		14.1	66.9	70.9	8200	5400	0.164	0.42	0.29	352	17.16
3x150+3x70/3E		16	71.9	75.9	9400	6750	0.132	0.46	0.28	404	21.45
3x185+3x95/3E		17.8	77.6	81.6	11300	8325	0.108	0.5	0.27	461	26.46

Rated voltage 8.7/15 kV

Number of cores x cross section	Conductor diameter max. mm	Outer diameter min. mm	Outer diameter max. mm	Net weight approx. kg/km	Permissible tensile force max. N	Conductor resistance at 20°C max. Ω/km	Nom. operating capacitance μF/km	Inductance nom. mH/km	Current carrying capacity (1) A	Short Circuit Current (conductor) kA
3x 25+3x25/3E	6.4	48.4	52.4	3700	1125	0.795	0.2	0.39	139	3.58
3x 35+3x25/3E	7.6	52.8	56.8	4300	1575	0.565	0.22	0.37	172	5.01
3x 50+3x25/3E	9	56.6	60.6	5000	2250	0.393	0.24	0.35	215	7.15
3x 70+3x35/3E	10.9	60.8	64.8	6300	3150	0.277	0.28	0.33	265	10.01
3x 95+3x50/3E	12.6	68	72	7700	4275	0.21	0.31	0.31	319	13.53
3x120+3x70/3E	14.1	71.7	75.7	8950	5400	0.164	0.33	0.3	371	17.16
3x150+3x70/3E	16	77.9	82.9	10500	6750	0.132	0.37	0.29	428	21.45
3x185+3x95/3E	17.8	81.8	86.8	12100	8325	0.108	0.4	0.28	488	26.46

Rated voltage 12/20 kV

Number of cores x cross section	Part number	Conductor diameter max. mm	Outer diameter min. mm	Outer diameter max. mm	Net weight approx. kg/km	Permissible tensile force max. N	Conductor resistance at 20°C max. Ω/km	Nom. operating capacitance μF/km	Inductance nom. mH/km	Current carrying capacity (1) A	Short Circuit Current (conductor) kA
3x 25+3x25/3E		6.4	54.4	58.5	4300	1125	0.795	0.17	0.41	139	3.58
3x 35+3x25/3E		7.6	57.1	61.1	4900	1575	0.565	0.19	0.39	172	5.01
3x 50+3x25/3E	20087015	9	59.9	63.9	5500	2250	0.393	0.21	0.37	215	7.15
3x 70+3x35/3E		10.9	66.9	70.9	7000	3150	0.277	0.24	0.35	265	10.01
3x 95+3x50/3E		12.6	72.3	76.3	8350	4275	0.21	0.26	0.33	319	13.53
3x120+3x70/3E		14.1	77.8	81.8	10000	5400	0.164	0.28	0.32	371	17.16
3x150+3x70/3E		16	82.3	87.3	11400	6750	0.132	0.31	0.31	428	21.45
3x185+3x95/3E		17.8	87.9	92.9	13300	8325	0.108	0.34	0.3	488	26.46

Rated voltage 14/25 kV

Number of cores x cross section	Part number	Conductor diameter max. mm	Outer diameter min. mm	Outer diameter max. mm	Net weight approx. kg/km	Permissible tensile force max. N	Conductor resistance at 20°C max. Ω/km	Nom. operating capacitance μF/km	Inductance nom. mH/km	Current carrying capacity (1) A	Short Circuit Current (conductor) kA
3x 25+3x25/3E	20008730	6.4	63	67	5450	1125	0.795	0.15	0.44	139	3.58
3x 35+3x25/3E		7.6	64.5	68.5	5900	1575	0.565	0.16	0.41	172	5.01
3x 50+3x25/3E		9	68.4	72.4	6700	2250	0.393	0.18	0.39	215	7.15
3x 70+3x35/3E		10.9	72.5	76.5	8000	3150	0.277	0.2	0.37	265	10.01
3x 95+3x50/3E		12.6	79.2	84.2	9700	4275	0.21	0.22	0.35	319	13.53
3x120+3x70/3E		14.1	82.9	87.9	11000	5400	0.164	0.24	0.34	371	17.16
3x150+3x70/3E		16	89.7	94.7	13000	6750	0.132	0.27	0.32	428	21.45
3x185+3x95/3E		17.8	93.6	98.6	15000	8325	0.108	0.29	0.31	488	26.46

Rated voltage 18/30 kV

Number of cores x cross section	Part number	Conductor diameter max. mm	Outer diameter min. mm	Outer diameter max. mm	Net weight approx. kg/km	Permissible tensile force max. N	Conductor resistance at 20°C max. Ω/km	Nom. operating capacitance μF/km	Inductance nom. mH/km	Current carrying capacity (1) A	Short Circuit Current (conductor) kA
3x 25+3x25/3E		6.4	67.1	71.1	6300	1125	0.795	0.14	0.46	139	3.58
3x 35+3x25/3E	20154158	7.6	69.7	73.7	7000	1575	0.565	0.15	0.43	172	5.01
3x 50+3x25/3E		9	75.4	79.4	7900	2250	0.393	0.16	0.41	215	7.15
3x 70+3x35/3E		10.9	79	84	9200	3150	0.277	0.18	0.38	265	10.01
3x 95+3x50/3E		12.6	86.2	91.2	10950	4275	0.21	0.2	0.37	319	13.53
3x120+3x70/3E		14.1	89.9	94.9	12400	5400	0.164	0.22	0.35	371	17.16
3x150+3x70/3E		16	94.9	99.9	13800	6750	0.132	0.23	0.34	428	21.45
3x185+3x95/3E		17.8	100.5	105.5	15950	8325	0.108	0.25	0.33	488	26.46

PROTOLON (ST) NTSCGEWOEU

Medium voltage flexible cables for use in water



Application

Power supply cable for use in water, e.g. for connection to dredgers, floating docks, pumps, etc., in applications where high mechanical stresses are to be expected. Also suitable for use in sewage, salt water and brackish water at water depths of up to 500 m.

Global data

Brand	PROTOLON(ST)
Type designation	NTSCGEWOEU
Standard	DIN VDE 0250-813
Certifications / Approvals	MSHA P-189-4 Fire Certificate of Russian Federation GOST K GOST B

Notes on installation

Notes on installation Suitable material sets for self-assembly or termination at manufacturer's factory workshop.

Design features

Conductor	Electrolytic copper, tinned, finely stranded (class 5)
PE-Conductor	Split into 3 in the outer interstices.
Insulation	Basic material: EPR, Compound type: 3GI3
Electrical field control	Inner and outer layer of semiconductive rubber compound
Core identification	Natural colouring with black semiconductive rubber
Core arrangement	Three main conductor laid-up with protective-earth conductor split into 3 in the outer interstices
Inner sheath	EPR inner sheath with special characteristics with respect to water proofing and prevention of formation of water bubbles, Compound type: GM1B.
Outer sheath	Basic material: synthetic elastomer compound e.g. CM, particularly water-proof, Compound type: 5GM3, Color: Red

Electrical parameters

Rated voltage	1.8/3 kV	3.6/6 kV	6/10 kV	8.7/15 kV	12/20 kV	14/25 kV	18/30 kV
Maximum permissible operating voltage AC	2.1/3.6 kV	4.2/7.2 kV	6.9/12 kV	10.4/18 kV	13.9/24 kV	17.3/30 kV	20.8/36 kV
Maximum permissible operating voltage DC	2.7/5.4 kV	5.4/10.8 kV	9/18 kV	13.5/27 kV	18/36 kV	22.5/45 kV	27/54 kV
AC test voltage	6 kV	11 kV	17 kV	24 kV	29 kV	36 kV	43 kV

Chemical parameters

Resistance to fire	EN 60332-1-2; IEC 60332-1-2
Resistance to oil	EN 60811-404, IEC 60811-404
Weather resistance	Unrestricted use outdoors and indoors, resistant to ozone, UV, and moisture
Water resistance	EN 50525-2-21

Thermal parameters

Max. permissible temperature at conductor	90 °C
Max. short circuit temperature of the conductor	250 °C
Ambient temperature for fix installation min.	-40 °C
Ambient temperature for fix installation max.	80 °C
Ambient temp. in fully flex. operation min.	-25 °C
Ambient temp. in fully flex. operation max.	60 °C

Mechanical parameters

Max. tensile load of cable	15 N/mm ²
Torsional stress	100 °/m
Bending radii min.	Acc. to DIN VDE 0298 part 3

Rated voltage 1.8/3 kV

Number of cores x cross section	Part number	Conductor diameter max. mm	Outer diameter min. mm	Outer diameter max. mm	Net weight approx. kg/km	Permissible tensile force max. N	Conductor resistance at 20°C max. Ω/km	Nom. operating capacitance μF/km	Inductance nom. mH/km	Current carrying capacity (1) A	Short Circuit Current (conductor) kA
3x25+3x25/3	20117795	6.4	36.1	39.1	2250	1125	0.795	0.33	0.33	131	3.58
3x35+3x25/3	20166303	7.6	37.8	40.8	2600	1575	0.565	0.38	0.31	162	5.01
3x50+3x25/3	20166304	9	42.1	45.1	3320	2250	0.393	0.43	0.3	202	7.15
3x70+3x35/3		10.9	47.4	50.4	4350	3150	0.277	0.5	0.28	250	10.01
3x95+3x50/3	20025759	12.6	53.2	57.2	5650	4275	0.21	0.52	0.27	301	13.53
3x120+3x70/3		14.1	56.4	60.4	6710	5400	0.164	0.56	0.27	352	17.16
3x150+3x70/3	20166300	16	60.4	64.4	7800	6750	0.132	0.63	0.26	404	21.45
3x185+3x95/3		17.8	66.9	70.9	9450	8325	0.108	0.69	0.25	461	26.46
3x240+3x120/3		20.4	72.4	76.4	11000	10800	0.0817	0.77	0.25	544	34.32

Rated voltage 3.6/6 kV

Number of cores x cross section	Part number	Conductor diameter max. mm	Outer diameter min. mm	Outer diameter max. mm	Net weight approx. kg/km	Permissible tensile force max. N	Conductor resistance at 20°C max. Ω/km	Nom. operating capacitance μF/km	Inductance nom. mH/km	Current carrying capacity (1) A	Short Circuit Current (conductor) kA
3x25+3x25/3	20004485	6.4	40.1	43.1	2620	1125	0.795	0.26	0.35	131	3.58
3x35+3x25/3	20040326	7.6	42.6	45.6	3060	1575	0.565	0.29	0.33	162	5.01
3x50+3x25/3	20004486	9	45.6	48.6	3680	2250	0.393	0.33	0.32	202	7.15
3x70+3x35/3		10.9	50.9	54.9	4950	3150	0.277	0.38	0.3	250	10.01
3x95+3x50/3		12.6	55.8	59.8	6000	4275	0.21	0.43	0.29	301	13.53
3x120+3x70/3	20058135	14.2	59.1	63.1	7070	5400	0.164	0.47	0.28	352	17.16
3x150+3x70/3		16	65.6	69.6	8470	6750	0.132	0.52	0.27	404	21.45
3x185+3x95/3		17.8	69.4	73.4	9850	8325	0.108	0.56	0.26	461	26.46
3x240+3x120/3		20.4	76.7	80.7	11500	10800	0.0817	0.63	0.25	544	34.32

Rated voltage 6/10 kV

Number of cores x cross section	Part number	Conductor diameter max. mm	Outer diameter min. mm	Outer diameter max. mm	Net weight approx. kg/km	Permissible tensile force max. N	Conductor resistance at 20°C max. Ω/km	Nom. operating capacitance μF/km	Inductance nom. mH/km	Current carrying capacity (1) A	Short Circuit Current (conductor) kA
3x25+3x25/3	20004595	6.4	41.7	44.7	2770	1125	0.795	0.24	0.36	138	3.58
3x35+3x25/3	20006946	7.6	44.3	47.3	3230	1575	0.565	0.27	0.34	171	5.01
3x50+3x25/3	20004596	9	48.9	52.9	4100	2250	0.393	0.3	0.32	214	7.15
3x 70+3x35/3E	20004598	10.9	57.3	61.3	5580	3150	0.277	0.34	0.31	250	10.01
3x70+3x35/3	20016313	10.9	53.8	57.8	5170	3150	0.277	0.34	0.31	265	10.01
3x 95+3x50/3E	20035932	12.6	63.2	67.2	6960	4275	0.21	0.38	0.29	301	13.53
3x95+3x50/3	20024967	12.6	57.4	61.4	6200	4275	0.21	0.38	0.29	321	13.53
3x120+3x70/3		14.1	60.6	64.6	7270	5400	0.164	0.42	0.29	372	17.16
3x150+3x70/3	20007894	16	66.4	70.4	8700	6750	0.132	0.46	0.28	428	21.45
3x185+3x95/3		17.8	71.1	75.1	10100	8325	0.108	0.5	0.27	488	26.46
3x240+3x120/3		20.4	77.9	82.9	12000	10800	0.0817	0.56	0.26	575	34.32

Rated voltage 8.7/15 kV

Number of cores x cross section	Part number	Conductor diameter max. mm	Outer diameter min. mm	Outer diameter max. mm	Net weight approx. kg/km	Permissible tensile force max. N	Conductor resistance at 20°C max. Ω/km	Nom. operating capacitance μF/km	Inductance nom. mH/km	Current carrying capacity (1) A	Short Circuit Current (conductor) kA
3x25+3x25/3	20024469	6.4	46.4	49.4	3250	1125	0.795	0.2	0.39	138	3.58
3x35+3x25/3		7.6	48.5	52.5	3730	1575	0.565	0.22	0.37	171	5.01
3x50+3x25/3	20025240	9	53.3	57.3	4630	2250	0.393	0.24	0.35	214	7.15
3x70+3x35/3		10.9	57.3	61.3	5780	3150	0.277	0.28	0.33	265	10.01
3x95+3x50/3		12.6	63.9	67.9	7100	4275	0.21	0.31	0.31	321	13.53
3x120+3x70/3		14.1	67.1	71.1	8250	5400	0.164	0.33	0.3	372	17.16
3x150+3x70/3		16	72	76	9450	6750	0.132	0.37	0.29	428	21.45
3x185+3x95/3	20085931	17.8	76.6	80.6	11200	8325	0.108	0.4	0.28	488	26.46
3x240+3x120/3		20.4	82.6	87.6	12700	10800	0.0817	0.44	0.27	575	34.32

Rated voltage 12/20 kV

Number of cores x cross section	Part number	Conductor diameter max. mm	Outer diameter min. mm	Outer diameter max. mm	Net weight approx. kg/km	Permissible tensile force max. N	Conductor resistance at 20°C max. Ω/km	Nom. operating capacitance μF/km	Inductance nom. mH/km	Current carrying capacity (1) A	Short Circuit Current (conductor) kA
3x25+3x25/3	20004726	6.4	52	56	3960	1125	0.795	0.17	0.41	138	3.58
3x35+3x25/3	20152410	7.6	54.5	58.5	4460	1575	0.565	0.19	0.39	171	5.01
3x 50+3x25/3E	20087015	9	59.9	63.9	5500	2250	0.393	0.21	0.37	215	7.15
3x50+3x25/3	20004722	9	57.4	61.4	5190	2250	0.393	0.21	0.37	214	7.15
3x70+3x35/3		10.9	63.3	67.3	6650	3150	0.277	0.24	0.35	265	10.01
3x95+3x50/3		12.6	68.2	72.2	7760	4275	0.21	0.26	0.33	321	13.53
3x120+3x70/3		14.1	71.3	75.3	8930	5400	0.164	0.28	0.32	372	17.16
3x150+3x70/3		16	77.5	82.5	10500	6750	0.132	0.31	0.31	428	21.45
3x185+3x95/3		17.8	81.3	86.3	12000	8325	0.108	0.34	0.3	488	26.46
3x240+3x120/3		20.4	88.6	93.6	13800	10800	0.0817	0.38	0.29	575	34.32

Rated voltage 14/25 kV

Number of cores x cross section	Part number	Conductor diameter max. mm	Outer diameter min. mm	Outer diameter max. mm	Net weight approx. kg/km	Permissible tensile force max. N	Conductor resistance at 20°C max. Ω/km	Nom. operating capacitance μF/km	Inductance nom. mH/km	Current carrying capacity (1) A	Short Circuit Current (conductor) kA
3x25+3x25/3		6.4	57.5	61.5	4670	1125	0.795	0.15	0.44	138	3.58
3x35+3x25/3	20061126	7.6	60	64	5210	1575	0.565	0.16	0.41	171	5.01
3x50+3x25/3		9	64.8	68.8	6220	2250	0.393	0.18	0.39	214	7.15
3x70+3x35/3		10.9	68.8	72.8	7500	3150	0.277	0.2	0.37	265	10.01
3x95+3x50/3		12.6	75.5	79.5	9000	4275	0.21	0.22	0.35	321	13.53
3x120+3x70/3		14.1	78.1	83.1	12250	5400	0.164	0.24	0.34	372	17.16
3x150+3x70/3		16	83	88	11600	6750	0.132	0.27	0.32	428	21.45
3x185+3x95/3		17.8	88.6	93.6	13500	8325	0.108	0.29	0.31	488	26.46
3x240+3x120/3		20.4	94.1	99.1	15500	10800	0.0817	0.32	0.3	575	34.32

Rated voltage 18/30 kV

Number of cores x cross section	Part number	Conductor diameter max. mm	Outer diameter min. mm	Outer diameter max. mm	Net weight approx. kg/km	Permissible tensile force max. N	Conductor resistance at 20°C max. Ω/km	Nom. operating capacitance μF/km	Inductance nom. mH/km	Current carrying capacity (1) A	Short Circuit Current (conductor) kA
3x25+3x25/3		6.4	64.3	68.3	5650	1125	0.795	0.14	0.46	138	3.58
3x35+3x25/3		7.6	66.9	70.9	6230	1575	0.565	0.15	0.43	171	5.01
3x50+3x25/3		9	69.9	73.9	7030	2250	0.393	0.16	0.41	214	7.15
3x70+3x35/3	20157145	10.9	75.7	79.7	8700	3150	0.277	0.18	0.38	265	10.01
3x95+3x50/3	20157146	12.6	80	85	9920	4275	0.21	0.2	0.37	321	13.53
3x120+3x70/3		14.1	83.2	88.2	11280	5400	0.164	0.22	0.35	372	17.16
3x150+3x70/3	20157147	16	89.9	94.9	12920	6750	0.132	0.23	0.34	428	21.45
3x185+3x95/3		17.8	93.7	98.7	14500	8325	0.108	0.25	0.33	488	26.46
3x240+3x120/3		20.4	101	106	16500	10800	0.0817	0.28	0.32	575	34.32

PROTOLON (M)-F

Medium voltage flexible cables for semi-flexible installation



Application

For laying alongside the conveyor belts (also for shiftable units) and on material handling equipment (even with continuous movement such as in cable booms or as connection between upper and lower car) and for connection of submersible pump units.

Global data

Brand	PROTOLON(M)
Type designation	F-(N)TSCGEW0EU
Standard	Based on DIN VDE 0250-813
Certifications / Approvals	MSHA P-189-4 Fire Certificate of Russian Federation GOST K GOST B

Notes on installation

Notes on installation Suitable material sets for self-assembly or termination at manufacturer's factory workshop.

Design features

Conductor	Electrolytic copper, not tinned, very finely stranded (class 5)
Insulation	PROTOLON, Basic material: EPR, Compound type: Special compound, better 3GI3
Electrical field control	Inner and outer layer of semiconductive rubber compound
Core identification	Natural coloring with black semiconductive rubber on which white digits 1 to 3 are printed
Core arrangement	Three main conductors laid-up, with protective-earth conductor split into 3 in the outer interstices
Inner sheath	Basic material: EPR, Compound type: Special compound
Outer sheath	Basic material: Synthetic elastomer compound e.g. CM, Compound type: better 5GM3, Color: Red

Electrical parameters

Rated voltage	3.6/6 kV	6/10 kV	8.7/15 kV	12/20 kV	14/25 kV	18/30 kV
Maximum permissible operating voltage AC	4.2/7.2 kV	6.9/12 kV	10.4/18 kV	13.9/24 kV	17.3/30 kV	20.8/36 kV
Maximum permissible operating voltage DC	5.4/10.8 kV	9/18 kV	13.5/27 kV	18/36 kV	22.5/45 kV	27/54 kV
AC test voltage	11 kV	17 kV	24 kV	29 kV	36 kV	43 kV

Chemical parameters

Resistance to fire	EN 60332-1-2, IEC 60332-1-2
Resistance to oil	EN 60811-404, IEC 60811-404.
Weather resistance	Unrestricted use outdoors and indoors, resistant to ozone, UV and moisture
Water resistance	EN 50525-2-21

Thermal parameters

Max. permissible temperature at conductor	90 °C
Max. short circuit temperature of the conductor	250 °C
Ambient temperature for fix installation min.	-40 °C
Ambient temperature for fix installation max.	80 °C
Ambient temperature in fully flexible operation min.	-25 °C
Ambient temperature in fully flexible operation max.	60 °C

Mechanical parameters

Max. tensile load of cable	15 N/mm ²
Torsional stress	100 °/m
Bending radii min.	Acc. to DIN VDE 0298 part 3
Additional tests	Torsional StressTest, Roller Bending Test Type C

Rated voltage 3.6/6 kV

Number of cores x cross section	Part number	Conductor diameter max. mm	Outer diameter min. mm	Outer diameter max. mm	Net weight approx. kg/km	Permissible tensile force max. N	Conductor resistance at 20°C max. Ω/km	Nom. operating capacitance μF/km	Inductance nom. mH/km	Current carrying capacity (1) A	Short Circuit Current (conductor) kA
3x25+3x25/3	20004523	6.4	33.6	36.6	2030	1125	0.78	0.35	0.32	131	3.58
3x35+3x25/3	20006941	7.6	36.1	39.1	2430	1575	0.554	0.39	0.31	162	5.01
3x50+3x25/3	20007759	9.1	40.4	43.4	3120	2250	0.386	0.45	0.29	202	7.15
3x70+3x35/3	20001438	10.8	43.9	46.9	3950	3150	0.272	0.51	0.28	250	10.01
3x95+3x50/3	20004522	12.7	49.7	53.7	5170	4275	0.206	0.58	0.27	301	13.6
3x120+3x70/3	20004520	14.3	53.1	57.1	6260	5400	0.161	0.64	0.26	352	17.16
3x150+3x70/3		16	57.7	61.7	7390	6750	0.129	0.71	0.25	404	21.45
3x185+3x95/3	20007275	17.7	61.7	65.7	8780	8325	0.106	0.77	0.25	462	26.46

Rated voltage 6/10 kV

Number of cores x cross section	Part number	Conductor diameter max. mm	Outer diameter min. mm	Outer diameter max. mm	Net weight approx. kg/km	Permissible tensile force max. N	Conductor resistance at 20°C max. Ω/km	Nom. operating capacitance μF/km	Inductance nom. mH/km	Current carrying capacity (1) A	Short Circuit Current (conductor) kA
3x25+3x25/3	20004612	6.4	34.9	37.9	2120	1125	0.78	0.31	0.33	131	3.58
3x35+3x25/3	20004615	7.6	38.4	41.4	2610	1575	0.554	0.35	0.32	162	5.01
3x50+3x25/3	20007428	9.1	41.6	44.6	3230	2250	0.386	0.4	0.3	202	7.15
3x70+3x35/3	20004639	10.8	45.2	48.2	4080	3150	0.272	0.46	0.29	250	10.01
3x95+3x50/3	20004641	12.7	50.4	54.4	5310	4275	0.206	0.52	0.27	301	13.6
3x120+3x70/3	20004619	14.3	54.4	58.4	6410	5400	0.161	0.57	0.27	352	17.16
3x150+3x70/3	20004642	16	57.9	61.9	7450	6750	0.129	0.63	0.26	404	21.45
3x185+3x95/3	20004643	17.7	62.5	66.5	8940	8325	0.106	0.68	0.25	462	26.46

Rated voltage 8.7/15 kV

Number of cores x cross section	Conductor diameter max. mm	Outer diameter min. mm	Outer diameter max. mm	Net weight approx. kg/km	Permissible tensile force max. N	Conductor resistance at 20°C max. Ω/km	Nom. operating capacitance μF/km	Inductance nom. mH/km	Current carrying capacity (1) A	Short Circuit Current (conductor) kA
3x25+3x25/3	6.4	39.3	42.3	2490	1125	0.78	0.24	0.36	139	3.58
3x35+3x25/3	7.6	41.8	44.8	2930	1575	0.554	0.27	0.34	172	5.01
3x50+3x25/3	9.1	45	48	3550	2250	0.386	0.3	0.32	215	7.15
3x70+3x35/3	10.8	49.5	53.5	4590	3150	0.272	0.34	0.31	265	10.01
3x95+3x50/3	12.7	54.4	58.4	5710	4275	0.202	0.39	0.29	319	13.6
3x120+3x70/3	14.3	57.7	61.7	6820	5400	0.161	0.42	0.28	371	17.16
3x150+3x70/3	16	63.8	67.8	8220	6750	0.129	0.46	0.28	428	21.45
3x185+3x95/3	17.7	67.3	71.3	9540	8325	0.106	0.5	0.27	488	26.46

Rated voltage 12/20 kV

Number of cores x cross section	Part number	Conductor diameter max. mm	Outer diameter min. mm	Outer diameter max. mm	Net weight approx. kg/km	Permissible tensile force max. N	Conductor resistance at 20°C max. Ω/km	Nom. operating capacitance μF/km	Inductance nom. mH/km	Current carrying capacity (1) A	Short Circuit Current (conductor) kA
3x25+3x25/3	20008856	6.4	42.3	45.3	2750	1125	0.78	0.22	0.37	139	3.58
3x35+3x25/3		7.6	44.8	47.8	3210	1575	0.554	0.24	0.35	172	5.01
3x50+3x25/3	20014374	9.1	47.9	50.9	3850	2250	0.386	0.27	0.33	215	7.15
3x70+3x35/3	20007431	10.8	52.4	56.4	4920	3150	0.272	0.31	0.32	265	10.01
3x95+3x50/3	20101416	12.7	56.5	60.5	5950	4275	0.206	0.35	0.3	319	13.6
3x120+3x70/3		14.3	62.1	66.1	7400	5400	0.161	0.38	0.29	371	17.16
3x150+3x70/3		16	66.8	70.8	6840	6750	0.129	0.41	0.28	428	21.45
3x185+3x95/3		17.7	70.3	74.3	9980	8325	0.106	0.45	0.28	488	26.46

Rated voltage 14/25 kV

Number of cores x cross section	Part number	Conductor diameter max. mm	Outer diameter min. mm	Outer diameter max. mm	Net weight approx. kg/km	Permissible tensile force max. N	Conductor resistance at 20°C max. Ω/km	Nom. operating capacitance μF/km	Inductance nom. mH/km	Current carrying capacity (1) A	Short Circuit Current (conductor) kA
3x25+3x25/3		6.4	46	49	3120	1125	0.78	0.19	0.4	139	3.58
3x35+3x25/3	20098412	7.6	49.5	53.5	3770	1575	0.554	0.21	0.37	172	5.01
3x50+3x25/3		9.1	52.6	56.6	4430	2250	0.386	0.23	0.35	215	7.15
3x70+3x35/3	20008497	10.8	56.2	60.2	5380	3150	0.272	0.26	0.33	265	10.01
3x95+3x50/3		12.7	62.5	66.5	6770	4275	0.206	0.29	0.32	319	13.6
3x120+3x70/3	20129015	14.3	65.9	69.9	7930	5400	0.161	0.32	0.31	371	17.16
3x150+3x70/3		16	70.6	74.6	9210	6750	0.129	0.35	0.3	428	21.45
3x185+3x95/3		17.7	75.5	79.5	10820	8325	0.106	0.38	0.29	488	26.46

Rated voltage 18/30 kV

Number of cores x cross section	Part number	Conductor diameter max. mm	Outer diameter min. mm	Outer diameter max. mm	Net weight approx. kg/km	Permissible tensile force max. N	Conductor resistance at 20°C max. Ω/km	Nom. operating capacitance μF/km	Inductance nom. mH/km	Current carrying capacity (1) A	Short Circuit Current (conductor) kA
3x25+3x25/3		6.4	50.4	54.4	3650	1125	0.78	0.17	0.42	139	3.58
3x35+3x25/3	20014796	7.6	52.9	56.9	4140	1575	0.554	0.18	0.39	172	5.01
3x50+3x25/3		9.1	56	60	4850	2250	0.386	0.2	0.37	215	7.15
3x70+3x35/3		10.8	61.1	65.1	6010	3150	0.272	0.23	0.35	265	10.01
3x95+3x50/3	20008614	12.7	65.1	69.1	7100	4275	0.206	0.25	0.33	319	13.6
3x120+3x70/3	20004748	14.3	68.8	72.8	8360	5400	0.161	0.28	0.32	371	17.16
3x150+3x70/3		16	75.3	79.3	9970	6750	0.129	0.3	0.31	428	21.45
3x185+3x95/3	20007274	17.7	78.9	82.9	11400	8325	0.106	0.32	0.3	488	26.46

Opencast Mining



CABLES FOR SEMI-FLEXIBLE INSTALLATION

	PROTOLON(M)-F	PROTOMONT NSSHOEU	PROTOMONT(M) (N)SHOEU	PROTOMONT EMV-FC
Application	MV semi-fixed	LV semi-fixed	LV semi-fixed	LV frequency converter cable
Permissible tensile force	max. 15N/mm ²	max. 15N/mm ²	max. 15N/mm ²	max. 15N/mm ²
Cable design	based on VDE	acc. to VDE	based on VDE	acc. to VDE
Sheath quality	5GM3	5GM5	5GM3	5GM5
Sheath abrasion	++	+++	++	+++
Reserved bending stability	++	++	++	++
Stability against water penetration	++	+++	++	+++
Temperature range in fully flexible operation	-25°C to +60°C	-25°C to +60°C	-25°C to +60°C	-25°C to +60°C -45°C to +60°C
Approvals	Gost K, Gost B	TR-certificate, Fire certificate, Gost K, Gost B, MSHA P-189-3	TR-certificate, Fire certificate, Gost K, Gost B	TR-certificate, Fire certificate, Gost K, Gost B, MSHA P-189-3

PROTOLON (M)-F

Medium voltage flexible cables for semi-flexible installation



Application

For laying alongside the conveyor belts (also for shiftable units) and on material handling equipment (even with continuous movement such as in cable booms or as connection between upper and lower car) and for connection of submersible pump units.

Global data

Brand	PROTOLON(M)
Type designation	F-(N)TSCGEWOEU
Standard	Based on DIN VDE 0250-813
Certifications / Approvals	MSHA P-189-4 Fire Certificate of Russian Federation GOST K GOST B

Notes on installation

Notes on installation Suitable material sets for self-assembly or termination at manufacturer's factory workshop.

Design features

Conductor	Electrolytic copper, not tinned, very finely stranded (class 5)
Insulation	PROTOLON, Basic material: EPR, Compound type: Special compound, better 3GI3
Electrical field control	Inner and outer layer of semiconductive rubber compound
Core identification	Natural coloring with black semiconductive rubber on which white digits 1 to 3 are printed
Core arrangement	Three main conductors laid-up, with protective-earth conductor split into 3 in the outer interstices
Inner sheath	Basic material: EPR, Compound type: Special compound
Outer sheath	Basic material: Synthetic elastomer compound e.g. CM, Compound type: better 5GM3, Color: Red

Electrical parameters

Rated voltage	3.6/6 kV	6/10 kV	8.7/15 kV	12/20 kV	14/25 kV	18/30 kV
Maximum permissible operating voltage AC	4.2/7.2 kV	6.9/12 kV	10.4/18 kV	13.9/24 kV	17.3/30 kV	20.8/36 kV
Maximum permissible operating voltage DC	5.4/10.8 kV	9/18 kV	13.5/27 kV	18/36 kV	22.5/45 kV	27/54 kV
AC test voltage	11 kV	17 kV	24 kV	29 kV	36 kV	43 kV

Chemical parameters

Resistance to fire	EN 60332-1-2, IEC 60332-1-2
Resistance to oil	EN 60811-404, IEC 60811-404.
Weather resistance	Unrestricted use outdoors and indoors, resistant to ozone, UV and moisture
Water resistance	EN 50525-2-21

Thermal parameters

Max. permissible temperature at conductor	90 °C
Max. short circuit temperature of the conductor	250 °C
Ambient temperature for fix installation min.	-40 °C
Ambient temperature for fix installation max.	80 °C
Ambient temperature in fully flexible operation min.	-25 °C
Ambient temperature in fully flexible operation max.	60 °C

Mechanical parameters

Max. tensile load of cable	15 N/mm ²
Torsional stress	100 °/m
Bending radii min.	Acc. to DIN VDE 0298 part 3
Additional tests	Torsional StressTest, Roller Bending Test Type C

Rated voltage 3.6/6 kV

Number of cores x cross section	Part number	Conductor diameter max. mm	Outer diameter min. mm	Outer diameter max. mm	Net weight approx. kg/km	Permissible tensile force max. N	Conductor resistance at 20°C max. Ω/km	Nom. operating capacitance μF/km	Inductance nom. mH/km	Current carrying capacity (1) A	Short Circuit Current (conductor) kA
3x25+3x25/3	20004523	6.4	33.6	36.6	2030	1125	0.78	0.35	0.32	131	3.58
3x35+3x25/3	20006941	7.6	36.1	39.1	2430	1575	0.554	0.39	0.31	162	5.01
3x50+3x25/3	20007759	9.1	40.4	43.4	3120	2250	0.386	0.45	0.29	202	7.15
3x70+3x35/3	20001438	10.8	43.9	46.9	3950	3150	0.272	0.51	0.28	250	10.01
3x95+3x50/3	20004522	12.7	49.7	53.7	5170	4275	0.206	0.58	0.27	301	13.6
3x120+3x70/3	20004520	14.3	53.1	57.1	6260	5400	0.161	0.64	0.26	352	17.16
3x150+3x70/3		16	57.7	61.7	7390	6750	0.129	0.71	0.25	404	21.45
3x185+3x95/3	20007275	17.7	61.7	65.7	8780	8325	0.106	0.77	0.25	462	26.46

Rated voltage 6/10 kV

Number of cores x cross section	Part number	Conductor diameter max. mm	Outer diameter min. mm	Outer diameter max. mm	Net weight approx. kg/km	Permissible tensile force max. N	Conductor resistance at 20°C max. Ω/km	Nom. operating capacitance μF/km	Inductance nom. mH/km	Current carrying capacity (1) A	Short Circuit Current (conductor) kA
3x25+3x25/3	20004612	6.4	34.9	37.9	2120	1125	0.78	0.31	0.33	131	3.58
3x35+3x25/3	20004615	7.6	38.4	41.4	2610	1575	0.554	0.35	0.32	162	5.01
3x50+3x25/3	20007428	9.1	41.6	44.6	3230	2250	0.386	0.4	0.3	202	7.15
3x70+3x35/3	20004639	10.8	45.2	48.2	4080	3150	0.272	0.46	0.29	250	10.01
3x95+3x50/3	20004641	12.7	50.4	54.4	5310	4275	0.206	0.52	0.27	301	13.6
3x120+3x70/3	20004619	14.3	54.4	58.4	6410	5400	0.161	0.57	0.27	352	17.16
3x150+3x70/3	20004642	16	57.9	61.9	7450	6750	0.129	0.63	0.26	404	21.45
3x185+3x95/3	20004643	17.7	62.5	66.5	8940	8325	0.106	0.68	0.25	462	26.46

Rated voltage 8.7/15 kV

Number of cores x cross section	Conductor diameter max. mm	Outer diameter min. mm	Outer diameter max. mm	Net weight approx. kg/km	Permissible tensile force max. N	Conductor resistance at 20°C max. Ω/km	Nom. operating capacitance μF/km	Inductance nom. mH/km	Current carrying capacity (1) A	Short Circuit Current (conductor) kA
3x25+3x25/3	6.4	39.3	42.3	2490	1125	0.78	0.24	0.36	139	3.58
3x35+3x25/3	7.6	41.8	44.8	2930	1575	0.554	0.27	0.34	172	5.01
3x50+3x25/3	9.1	45	48	3550	2250	0.386	0.3	0.32	215	7.15
3x70+3x35/3	10.8	49.5	53.5	4590	3150	0.272	0.34	0.31	265	10.01
3x95+3x50/3	12.7	54.4	58.4	5710	4275	0.202	0.39	0.29	319	13.6
3x120+3x70/3	14.3	57.7	61.7	6820	5400	0.161	0.42	0.28	371	17.16
3x150+3x70/3	16	63.8	67.8	8220	6750	0.129	0.46	0.28	428	21.45
3x185+3x95/3	17.7	67.3	71.3	9540	8325	0.106	0.5	0.27	488	26.46

Rated voltage 12/20 kV

Number of cores x cross section	Part number	Conductor diameter max. mm	Outer diameter min. mm	Outer diameter max. mm	Net weight approx. kg/km	Permissible tensile force max. N	Conductor resistance at 20°C max. Ω/km	Nom. operating capacitance μF/km	Inductance nom. mH/km	Current carrying capacity (1) A	Short Circuit Current (conductor) kA
3x25+3x25/3	20008856	6.4	42.3	45.3	2750	1125	0.78	0.22	0.37	139	3.58
3x35+3x25/3		7.6	44.8	47.8	3210	1575	0.554	0.24	0.35	172	5.01
3x50+3x25/3	20014374	9.1	47.9	50.9	3850	2250	0.386	0.27	0.33	215	7.15
3x70+3x35/3	20007431	10.8	52.4	56.4	4920	3150	0.272	0.31	0.32	265	10.01
3x95+3x50/3	20101416	12.7	56.5	60.5	5950	4275	0.206	0.35	0.3	319	13.6
3x120+3x70/3		14.3	62.1	66.1	7400	5400	0.161	0.38	0.29	371	17.16
3x150+3x70/3		16	66.8	70.8	6840	6750	0.129	0.41	0.28	428	21.45
3x185+3x95/3		17.7	70.3	74.3	9980	8325	0.106	0.45	0.28	488	26.46

Rated voltage 14/25 kV

Number of cores x cross section	Part number	Conductor diameter max. mm	Outer diameter min. mm	Outer diameter max. mm	Net weight approx. kg/km	Permissible tensile force max. N	Conductor resistance at 20°C max. Ω/km	Nom. operating capacitance μF/km	Inductance nom. mH/km	Current carrying capacity (1) A	Short Circuit Current (conductor) kA
3x25+3x25/3		6.4	46	49	3120	1125	0.78	0.19	0.4	139	3.58
3x35+3x25/3	20098412	7.6	49.5	53.5	3770	1575	0.554	0.21	0.37	172	5.01
3x50+3x25/3		9.1	52.6	56.6	4430	2250	0.386	0.23	0.35	215	7.15
3x70+3x35/3	20008497	10.8	56.2	60.2	5380	3150	0.272	0.26	0.33	265	10.01
3x95+3x50/3		12.7	62.5	66.5	6770	4275	0.206	0.29	0.32	319	13.6
3x120+3x70/3	20129015	14.3	65.9	69.9	7930	5400	0.161	0.32	0.31	371	17.16
3x150+3x70/3		16	70.6	74.6	9210	6750	0.129	0.35	0.3	428	21.45
3x185+3x95/3		17.7	75.5	79.5	10820	8325	0.106	0.38	0.29	488	26.46

Rated voltage 18/30 kV

Number of cores x cross section	Part number	Conductor diameter max. mm	Outer diameter min. mm	Outer diameter max. mm	Net weight approx. kg/km	Permissible tensile force max. N	Conductor resistance at 20°C max. Ω/km	Nom. operating capacitance μF/km	Inductance nom. mH/km	Current carrying capacity (1) A	Short Circuit Current (conductor) kA
3x25+3x25/3		6.4	50.4	54.4	3650	1125	0.78	0.17	0.42	139	3.58
3x35+3x25/3	20014796	7.6	52.9	56.9	4140	1575	0.554	0.18	0.39	172	5.01
3x50+3x25/3		9.1	56	60	4850	2250	0.386	0.2	0.37	215	7.15
3x70+3x35/3		10.8	61.1	65.1	6010	3150	0.272	0.23	0.35	265	10.01
3x95+3x50/3	20008614	12.7	65.1	69.1	7100	4275	0.206	0.25	0.33	319	13.6
3x120+3x70/3	20004748	14.3	68.8	72.8	8360	5400	0.161	0.28	0.32	371	17.16
3x150+3x70/3		16	75.3	79.3	9970	6750	0.129	0.3	0.31	428	21.45
3x185+3x95/3	20007274	17.7	78.9	82.9	11400	8325	0.106	0.32	0.3	488	26.46

PROTOMONT NSSHOEU 1kV

Flexible rubber cables



Application

For flexible use and fixed installation open-cast mining applications, in quarries, on construction sites and similar applications, with heavy mechanical stresses. The cables can be used indoors as well as outdoors, in explosion-hazard areas, in industry and in agriculture. They can be used permanently in waste water up to 40°C at a depth of max. 500 m and in industrial water, cooling water, surface water, rainwater and mixed water - and in groundwater and seawater to a more limited extent. The requirements for accessibility and inspection depend on the consistency of the water. In aggressive water or composed of special substances, the cable's resistance properties should be tested. In other respects the specifications of DIN VDE 0298 part 3 applies.

Global data

Brand	PROTOMONT
Type	PROTOMONT NSSHÖU 0.6/1kV
Standard	DIN VDE 0250-812
Certifications / Approvals	MA – China MSHA P-189-3 Fire Certificate of Russian Federation TR-Certificate GOST K GOST B

Notes on installation

Notes on installation	Maximum Submersing Depth: 500 Meter
-----------------------	-------------------------------------

Design features

Conductor	Copper, tinned, finely stranded (class 5) in accordance with DIN VDE 0295/IEC 60228
Insulation	PROTOLON, Basic material: EPR, Compound type: 3GI3 in accordance with DIN VDE 0207
Core identification	Up to 5 cores: colored in gray, black, brown, blue, green/yellow, from 6 cores: light gray with black digits
Core arrangement	Three main conductors laid-up together with the protective-earth conductor, from 50 mm ² with protective-earth conductor split into three in the outer interstices
Inner sheath	Vulcanized rubber compound, Basic material: EPR, Compound type: GM1B in accordance with DIN VDE 0207 (not for single-core cables)
Outer sheath	Vulcanized rubber compound, synthetic elastomer compound e.g. CPE, Compound: 5GM5 in accordance with DIN VDE 0207, Color: Yellow

Electrical parameters

Rated voltage	0.6/1 kV (600/1000V)
Maximum permissible operating voltage AC	0.7/1.2 kV
Maximum permissible operating voltage DC	0.9/1.8 kV
AC test voltage	3 kV
Duration of AC test voltage	5 min.

Chemical parameters

Resistance to fire	EN 60332-1-2; IEC 60332-1-2
Resistance to oil	EN 60811-404, IEC 60811-404
Weather resistance	Unrestricted use outdoors and indoors, resistant to ozone and moisture
Water resistance	EN 50525-2-21

Thermal parameters

Max. permissible temperature at conductor	90 °C
Max. short circuit temperature of the conductor	250 °C
Max. permissible water temperature	40 °C (for higher temperatures a life time reduction is expected)
Ambient temperature for fix installation min.	-40 °C
Ambient temperature for fix installation max.	80 °C
Ambient temp. in fully flex. operation min.	-25 °C
Ambient temp. in fully flex. operation max.	60 °C

Mechanical parameters

Max. tensile load of cable	15 N/mm ²
Torsional stress	100 °/m
Bending radii min.	Acc. to DIN VDE 0298 part 3

Number of cores x cross section	Part number	Conductor diameter max. mm	Outer diameter min. mm	Outer diameter max. mm	Net weight approx. kg/km	Permissible tensile force max. N	Conductor resistance at 20°C max. Ω/km	Nom. operating capacitance μF/km	Inductance nom. mH/km	Current carrying capacity (1) A	Short Circuit Current (conductor) kA
PROTOMONT NSSHÖU-O 1x...											
1x16	20004811	5.4	10.6	11.6	235	240	1.21	0.42	0.26	103	2.29
1x25	20008654	6.3	12.8	13.7	355	375	0.7839	0.42	0.26	137	3.58
1x35	20004812	7.4	13.9	14.8	450	525	0.554	0.49	0.25	169	5.01
1x50	20004813	8.9	15.6	16.6	610	750	0.386	0.51	0.25	211	7.15
1x70	20004814	10.6	17.8	18.8	825	1050	0.272	0.59	0.24	261	10.01
1x95	20004815	12.1	19.7	20.7	1050	1425	0.206	0.6	0.24	314	13.59
1x120	20004816	14.2	22.4	23.4	1360	1800	0.161	0.69	0.23	367	17.16
1x150	20004817	15.8	24.4	25.4	1640	2250	0.129	0.69	0.23	422	21.45
1x185	20069571	17.2	27.2	28.8	2040	2775	0.106	0.68	0.23	481	26.46
1x240	20004818	20.2	30.4	32	2600	3600	0.08	0.73	0.23	571	34.32
1x300	20004819	22.9	34.5	36.8	3270	4500	0.064	0.76	0.23	681	42.9
PROTOMONT NSSHÖU-O 2x...											
2x1,5	20004826	1.6	10.8	11.9	160	45	13.3	0.22	0.33	23	0.21
2x2,5	20008593	1.9	12	13	205	75	7.98	0.23	0.32	30	0.36
2x4		2.4	14.5	15.5	295	120	4.95	0.26	0.31	41	0.57
PROTOMONT NSSHÖU-O 3x...											
3x1,5		1.6	11.3	12.3	180	68	13.3	0.22	0.33	23	0.21
3x2,5	20004872	1.9	12.5	13.6	230	113	7.98	0.23	0.32	30	0.36
3x4		2.4	15.1	16.2	340	180	4.95	0.26	0.31	41	0.57
3x6		2.9	16.2	17.3	415	270	3.3	0.3	0.29	53	0.86
3x10		3.9	20	21.1	650	450	1.91	0.32	0.28	74	1.43
3x16		5.4	23.1	24.2	890	720	1.21	0.42	0.26	99	2.29
3x25		6.3	26.8	28.5	1300	1125	0.784	0.42	0.26	131	3.58
3x35	20004837	7.5	30.9	32.5	1730	1575	0.554	0.49	0.25	162	5.01
3x50	20148227	8.9	35.2	38.3	2400	8325	0.106	0.39	0.27	461	26.46
PROTOMONT NSSHÖU-J 3x...											
3x1,5	20004827	1.6	11.3	12.3	180	68	13.3	0.22	0.33	23	0.21
3x2,5	20004828	1.9	12.5	13.6	230	113	7.98	0.23	0.32	30	0.36
3x4	20007174	2.4	15.2	16.2	340	180	4.95	0.26	0.31	41	0.57
3x6		2.9	16.2	17.3	415	270	3.3	0.3	0.29	53	0.86
PROTOMONT NSSHÖU-J 4x...											
4x1,5	20004838	1.6	12	13.1	210	90	13.3	0.22	0.33	23	0.21
4x2,5	20004839	1.9	14.6	15.7	310	150	7.98	0.23	0.32	30	0.36
4x4	20004840	2.4	16.2	17.3	410	240	4.95	0.26	0.31	41	0.57
4x6	20004841	2.9	17.4	18.5	500	360	3.3	0.3	0.29	53	0.86
4x10	20004842	3.9	21.8	22.9	800	600	1.91	0.32	0.28	74	1.43
4x16	20004843	5.4	25.9	27.6	1160	960	1.21	0.42	0.26	99	2.29
4x25	20004844	6.3	30.6	32.3	1700	1500	0.784	0.42	0.26	131	3.58
4x35	20004845	7.5	33.4	35.1	2150	2100	0.554	0.49	0.25	162	5.01
4x50	20004846	8.9	38.2	41.2	2980	3000	0.386	0.51	0.25	202	7.15
4x70	20004847	10.6	42.4	45.5	3910	4200	0.272	0.59	0.24	250	10.01
4x95	20004848	12.1	48.2	52.3	5120	5700	0.206	0.6	0.24	301	13.59
4x120	20016763	14.1	54.7	58.8	6570	7200	0.161	0.69	0.23	352	17.16
4x150	20023637	16	60.2	64.2	7990	9000	0.129	0.7	0.23	404	21.45

Number of cores x cross section	Part number	Conductor diameter max. mm	Outer diameter min. mm	Outer diameter max. mm	Net weight approx. kg/km	Permissible tensile force max. N	Conductor resistance at 20°C max. Ω/km	Nom. operating capacitance µF/km	Inductance nom. mH/km	Current carrying capacity (1) A	Short Circuit Current (conductor) kA
4x185	20007494	17.8	67.3	71.3	9820	11100	0.106	0.71	0.23	461	26.46
4x240	20060343	20.2	72.1	76.4	12100	14400	0.08	0.73	0.23	547	34.32
PROTOMONT NSSHÖU-J 3x.../...											
3x50/25	20004863	8.9	38.2	41.2	2820	2250	0.386	0.51	0.25	202	7.15
3x70/35	20004864	10.6	42.4	45.5	3670	3150	0.272	0.59	0.24	250	10.01
3x95/50	20004865	12.1	48.2	52.3	4840	4275	0.206	0.6	0.24	301	13.59
3x120/70	20004866	14.1	54.7	58.8	6250	5400	0.161	0.69	0.23	352	17.16
3x150/70	20004868	16	60.2	64.2	7500	6750	0.129	0.7	0.23	404	21.45
3x185/95	20004867	17.8	67.3	71.3	9290	8325	0.106	0.71	0.23	461	26.46
PROTOMONT NSSHÖU-J 3x... +3x.../3											
3x185 + 3x95/3		17.9	60.7	64.7	8690	8325	0.106	0.71	0.23	461	26.46
PROTOMONT NSSHÖU-J 5x...											
5x1,5	20004855	1.6	12.9	14	245	113	13.3	0.22	0.33	23	0.21
5x2,5	20004856	1.9	15.7	16.7	360	188	7.98	0.23	0.32	30	0.36
5x4	20004857	2.4	17.4	18.5	475	300	4.95	0.26	0.31	41	0.57
5x6	20004858	2.9	19.6	20.6	625	450	3.3	0.3	0.29	53	0.86
5x10	20004859	3.9	23.5	24.5	955	750	1.91	0.32	0.28	74	1.43
5x16	20004860	5.4	28	29.7	1380	1200	1.21	0.42	0.26	99	2.29
5x25	20004861	6.3	33.1	34.8	2030	1875	0.784	0.42	0.26	131	3.58
5x35	20006970	7.5	37	40.1	2700	2625	0.554	0.49	0.25	162	5.01
PROTOMONT NSSHÖU-J ...x1,5											
7x1,5	20004891	1.6	15.9	16.9	365	158	13.3	0.22	0.33	15	0.21
8x1,5	20004890	1.6	17.1	18.1	410	180	13.3	0.22	0.33	14	0.21
10x1,5	20004886	1.6	17.7	19.7	455	225	13.3	0.22	0.33	13	0.21
24x1,5	20088402	1.6	24.3	27.3	920	540	13.3	0.22	0.33	9	0.21
PROTOMONT NSSHÖU-J ...x2,5											
7x2,5	20004887	2	18	18.9	485	263	7.98	0.24	0.32	19	0.36
10x2,5		2	20.4	21.4	630	375	7.98	0.24	0.32	16	0.36
12x2,5	20004874	2	21.7	22.7	725	450	7.98	0.24	0.32	16	0.36
18x2,5	20004892	2	25.6	27.5	1035	675	7.98	0.24	0.32	13	0.36
24x2,5		2	28.6	30.2	1320	900	7.98	0.23	0.32	12	0.36
PROTOMONT NSSHÖU-J ...x4											
7x4	20059552	2.4	21	22	685	420	4.95	0.26	0.31	17	0.57
12x4	20040505	2.4	24.9	26.5	1030	720	4.95	0.26	0.31	21	0.57

PROTOMONT (M) (N)SHOEU 0.6/1kV

Flexible rubber cables



Application

Rubber-sheated flexible cables for open-cast mining, suitable for laying alongside conveyor belts (also for shiftable units) and on material handling equipment, even when the cable is moved continuously, e.g. in cable suspension fittings and as connection between upper and lower cars. The cables are also suitable for connection of submersible pump units.

Global data

Brand	PROTOMONT(M)
Type	PROTOMONT(M) (N)SHOEU 0.6/1kV
Type designation	(N)SHOEU
Standard	Based on DIN VDE 0250 part 812
Certifications / Approvals	Fire Certificate of Russian Federation TR-Zertifikat GOST K GOST B

Notes on installation

Maximum Submersing Depth	500 Meter
--------------------------	-----------

Design features

Conductor	Electrolytic copper, not tinned, finely stranded (class 5)
Insulation	PROTOLON, Basic material: EPR, Compound type: Special compound better 3GI3
Core identification	Light gray with black digits
Core arrangement	Three main conductors laid-up together with the protective-earth conductor, from 50 mm ² with protective-earth conductor split into three in the outer interstices
Inner sheath	Basic material: EPR, Compound type: Special compound
Outer sheath	Basic material: Chlorinated rubber, Compound type: Special compound, 5GM3, Color: Black

Electrical parameters

Rated voltage	U ₀ /U=450/750 V (Control cables); U ₀ /U=0.6/1 kV (Power cables)
Maximum permissible operating voltage AC	0.7/1.2 kV
Maximum permissible operating voltage DC	0.9/1.8 kV
AC test voltage	3 kV
AC test voltage - Control Cores	2 kV

Chemical parameters

Resistance to fire	EN 60332-1-2; IEC 60332-1-2
Resistance to oil	EN 60811-404, IEC 60811-404
Weather resistance	Unrestricted use outdoors and indoors, resistant to ozone and moisture
Water resistance	EN 50525-2-21

Thermal parameters

Max. permissible temperature at conductor	90 °C
Max. short circuit temperature of the conductor	250 °C
Max. permissible water temperature	40 °C (for higher temperatures a life time reduction is expected)
Ambient temperature for fix installation min.	-40 °C
Ambient temperature for fix installation max.	80 °C
Ambient temp. in fully flex. operation min.	-25 °C
Ambient temp. in fully flex. operation max.	60 °C

Mechanical parameters

Max. speed on rewinding with drum car	100 m/min Meter per minute
Tensile load on the conductor max .	15 N/mm ²
Torsional stress	100 °/m
Bending radii min.	Acc. to DIN VDE 0298 part 3

Number of cores x cross section	Part number	Conductor diameter max. mm	Outer diameter min. mm	Outer diameter max. mm	Net weight approx. kg/km	Permissible tensile force max. N	Conductor resistance at 20°C max. Ω/km	Nom. operating capacitance μF/km	Inductance nom. mH/km	Current carrying capacity (1) A	Short Circuit Current (conductor) kA
PROTOMONT (M) (N)SHOEU-J											
3x1,5	20004939	1.6	10.2	11.8	160	68	13.3	0.21	0.33	23	0.18
3x2,5	20004940	2	11.1	12.7	200	113	7.98	0.24	0.32	30	0.31
3x4	20040377	2.4	12.1	13.7	270	180	4.95	0.27	0.31	41	0.49
3x6	20004941	2.9	13.2	14.8	340	270	3.3	0.32	0.29	53	0.73
PROTOMONT(M) (N)SHOEU-J											
4x1,5		1.6	11	12.6	204	90	13.3	0.21	0.33	23	0.18
4x2,5	20004921	2	12	13.6	245	150	7.98	0.24	0.32	30	0.31
4x4	20004943	2.4	13	14.6	338	240	4.95	0.27	0.3	41	0.49
4x6	20004944	2.9	14.9	16.9	453	360	3.3	0.32	0.29	53	0.73
4x10	20004945	3.9	17.4	19.4	663	600	1.91	0.34	0.28	74	1.22
4x16	20004946	5.2	21.4	23.4	1020	960	1.12	0.44	0.26	99	1.95
4x25	20004947	6.4	24.5	27.5	1480	1500	0.78	0.45	0.26	131	3.05
4x35	20004948	7.5	28.4	31.4	1880	2100	0.554	0.52	0.25	162	4.27
4x50	20004949	9	33.6	36.6	2570	3000	0.386	0.54	0.25	202	6.1
4x70	20004950	10.6	39.5	42.5	3820	4200	0.272	0.61	0.24	250	8.45
4x95	20004938	12.8	44.8	47.8	4920	5700	0.206	0.64	0.24	301	11.59
4x120	20004942	14.4	49.9	53.9	6300	7200	0.161	0.72	0.23	352	14.64
4x150	20004967	16.1	54.9	58.9	7578	9000	0.129	0.72	0.23	404	18.3
PROTOMONT(M) (N)SHOEU-J											
3x50+3x25/3	20007826	9	29.4	32.4	2320	2250	0.386	0.54	0.25	202	6.1
3x70+3x35/3	20041925	10.6	34.8	37.8	3200	3150	0.272	0.61	0.24	250	8.54
3x95+3x50/3	20006972	12.8	40.9	43.9	4270	4275	0.206	0.64	0.24	301	11.59
3x120+3x70/3	20006971	14.4	44.7	47.7	5350	5400	0.161	0.72	0.23	352	14.64
3x150+3x70/3		16.1	51.6	55.6	6930	6750	0.129	0.72	0.23	404	18.3
3x185+3x95/3	20007432	17.9	54.5	58.5	8150	8325	0.106	0.71	0.23	461	22.57
3x240+3x120/3		20.6	62.2	66.2	10200	10800	0.08	0.76	0.23	540	26.56
3x300+3x150/3		23.4	70.3	74.3	13250	13500	0.064	0.78	0.23	633	29.28
PROTOMONT(M) (N)SHOEU-J											
5x1,5	20040380	1.6	11.9	13.5	245	113	13.3	0.21	0.33	23	0.18
5x2,5	20004951	2	12.9	14.5	297	188	7.98	0.24	0.32	30	0.31
5x4	20040379	2.4	14.7	16.7	414	300	4.95	0.27	0.3	41	0.49
5x6	20040378	2.9	16.1	18.1	530	450	3.3	0.32	0.29	53	0.73
5x10	20004952	3.9	19	21	795	750	1.91	0.34	0.28	74	1.22
5x16		5.2	23.2	25.2	1200	1200	1.21	0.44	0.26	99	1.95
5x25		6.4	28	31	1850	1875	0.78	0.45	0.26	131	3.05
PROTOMONT(M) (N)SHOEU-J											
7x1,5	20004928	1.6	12.9	14.5	288	158	13.3	0.21	0.33	23	0.18
8x1,5		1.6	13.8	15.4	325	180	13.3	0.21	0.33	23	0.18
10x1,5		1.6	15.5	17.5	400	225	13.3	0.21	0.33	23	0.18
12x1,5	20004929	1.6	15.8	17.8	400	270	13.3	0.21	0.33	23	0.18
14x1,5		1.6	16.8	18.8	495	315	13.3	0.21	0.33	23	0.18
19x1,5	20042550	1.6	18.9	20.9	620	427	13.3	0.21	0.33	23	0.18
7x2,5		2	14.9	16.9	417	263	7.98	0.24	0.32	30	0.31
8x2,5	20004930	2	15.8	17.8	452	300	7.98	0.24	0.32	30	0.31

Number of cores x cross section	Part number	Conductor diameter max. mm	Outer diameter min. mm	Outer diameter max. mm	Net weight approx. kg/km	Permissible tensile force max. N	Conductor resistance at 20°C max. Ω/km	Nom. operating capacitance μF/km	Inductance nom. mH/km	Current carrying capacity (1) A	Short Circuit Current (conductor) kA
10x2,5		2	16.4	18.4	500	375	7.98	0.24	0.32	30	0.31
12x2,5		2	17.3	19.3	561	450	7.98	0.24	0.32	30	0.31
14x2,5		2	18.7	20.7	660	525	7.98	0.24	0.32	30	0.31
18x2,5		2	21.2	23.2	840	675	7.98	0.24	0.32	30	0.31
19x2,5		2	22.3	24.3	900	712	7.98	0.24	0.32	30	0.31
24x2,5	20004931	2	22.8	24.8	1009	900	7.98	0.24	0.32	30	0.31
PROTOMONT(M) (N)SHOEU-O											
12x4	20004932	2.4	20.8	22.8	831	720	4.95	0.27	0.3	41	0.49
12x6	20004933	2.9	23.4	26.4	1129	1080	3.3	0.32	0.29	53	0.73
PROTOMONT(M) (N)SHOEU-O											
1x16		5.2	9.5	11.1	230	240	1.21	0.44	0.26	99	1.95
1x25		6.4	11	12.6	335	375	0.78	0.45	0.26	131	3.05
1x35		7.5	12.3	13.9	435	525	0.554	0.52	0.25	162	4.27
1x50		9	14.5	16.5	615	750	0.386	0.54	0.25	202	6.1
1x70	20096562	11.1	16.4	18.4	812	1050	0.272	0.61	0.24	250	8.54
1x95	20004920	12.8	18.5	20.5	1060	1425	0.206	0.64	0.24	301	11.59
1x120	20008751	14.5	20.4	22.4	1300	1800	0.161	0.72	0.23	352	14.64
1x150	20064454	16.5	22.8	24.8	1600	2250	0.129	0.72	0.23	404	18.3
1x185		17.9	24.7	27.7	2020	2775	0.106	0.71	0.23	461	22.57
1x240	20004922	21.2	27.6	30.6	2548	3600	0.08	0.76	0.23	547	29.28
1x300		23.6	31.6	34.6	3200	4500	0.064	0.78	0.23	633	36.6
PROTOMONT(M) (N)SHOEU-O											
2x1,5		1.6	9.8	11.4	145	45	13.3	0.21	0.33	23	0.18
2x2,5		2	10.7	12.3	185	75	7.98	0.24	0.32	30	0.31
2x4		2.4	11.9	13.5	220	120	4.95	0.27	0.3	41	0.49
PROTOMONT(M) (N)SHOEU-O											
3x2,5	20004953	2	11.1	12.7	213	113	7.98	0.24	0.32	30	0.31
3x4	20004954	2.4	12.1	13.7	271	180	4.985	0.27	0.3	41	0.49
3x6	20004955	2.9	13.2	14.8	347	270	3.3	0.32	0.29	53	0.73
3x10	20004956	3.9	16.1	18.1	505	450	1.91	0.34	0.28	74	1.22
3x16	20004957	5.2	19	21	775	720	1.12	0.44	0.26	99	1.95
3x25	20004958	6.4	22.9	24.9	1160	1125	0.78	0.45	0.26	131	3.05
3x35	20004959	7.5	24.9	27.9	1500	1575	0.554	0.52	0.25	162	4.27
3x50	20004960	9	29.4	32.4	2190	2250	0.386	0.54	0.25	202	6.1
3x70	20004961	11.1	34.8	37.8	2930	3150	0.272	0.61	0.24	250	8.54
3x95	20004962	12.8	40.9	43.9	3720	4275	0.206	0.64	0.24	301	11.59
3x120	20004963	14.4	44.7	47.7	4850	5400	0.161	0.72	0.23	352	14.64
3x150	20004964	16.1	50	54	6130	6750	0.129	0.72	0.23	404	18.3

PROTOMONT EMV-FC (N)SSHCOEU 0.6/1kV

Frequency converter cables

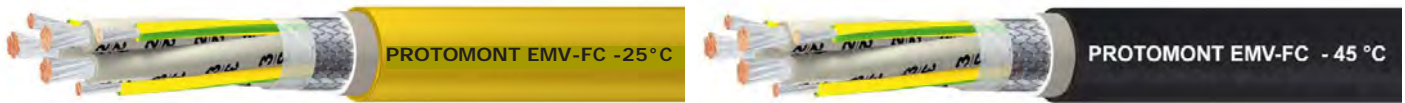

Application

The cables are suitable for fixed installation and flexible operation as motor power supply cables for frequency converter controlled drives in the mining industry, on construction sites and similar applications, with heavy mechanical stresses. For laying on material handling equipment (even with continuous movement such as in cable booms or as connection between upper and lower car). Can also be applied in water with up to 40°C; in wastewater up to approximately 10 m depth, in fresh water and salt water up to 500 m depth.

Global data

Brand	PROTOMONT EMV-FC
Type designation	(N)SSHCOEU
Standard	Based on DIN VDE 0250 part 812
Certifications / Approvals	MSHA P-189-3 Fire Certificate of Russian Federation TR-Certificate GOST K GOST B

Design features

Conductor	Finely stranded copper conductor, tinned (class 5) according to DIN VDE 0295
Insulation	PROTOLON, Basic material: EPR, Compound type: 3GI3
Core identification	Natural coloring with black figures
Core arrangement	Three power cores laid up with the protective earth conductors split into three in the outer interstices
Screen	EMC optimized, concentric braid of tinned copper wires
Inner sheath	Vulcanized rubber compound, Basic material: EPR, Compound type: GM1B
Outer sheath	PROTOFIRM, synthetic elastomer compound e.g. CR, Compound type: 5GM5, Color: Yellow

Electrical parameters

Rated voltage	$U_0/U = 0,6/1$ kV, also permitted for $U_0/U = 640/1140$ V
Maximum permissible operating voltage AC	0.7/1.2 kV
Maximum permissible operating voltage DC	0.9/1.8 kV
AC test voltage	5 kV

Chemical parameters

Resistance to fire	EN 60332-1-2, IEC 60332-1-2
Resistance to oil	Given in accordance with EN 60811-404, IEC 60811-404
Weather resistance	Unrestricted use outdoors and indoors, resistant to ozone and moisture

Thermal parameters

Max. permissible temperature at conductor	90 °C	90 °C
Max. short circuit temperature of the conductor	250 °C	250 °C
Ambient temperature for fix installation min.	-40 °C	-60 °C
Ambient temperature for fix installation max.	80 °C	80 °C
Ambient temperature in fully flexible operation min.	-25 °C	-45 °C
Ambient temperature in fully flexible operation max.	60 °C	60 °C

Mechanical parameters

Tensile load on the conductor max .	15 N/mm ²
Torsional stress	25 °/m
Bending radii min.	Acc. to DIN VDE 0298 part 3

-25°C

Number of cores x cross section	Part number	Conductor diameter max. mm	Outer diameter min. mm	Outer diameter max. mm	Net weight approx. kg/km	Permissible tensile force max. N	Conductor resistance at 20°C max. Ω/km	Nom. operating capacitance μF/km	Inductance nom. mH/km	Current carrying capacity (1) A	Short Circuit Current (conductor) kA
3 x 16 + 3 x 2,5	20004904	5.4	24.4	27.4	1150	720	1240	0.42	0.26	99	1.95
3 x 25 + 3 x 4	20016716	6.3	28.2	31.2	1630	1125	0.795	0.42	0.26	131	3.05
3 x 35 + 3 x 16/3	20004903	7.5	30.5	33.5	1950	1575	0.565	0.49	0.25	162	4.27
3 x 50 + 3 x 25/3	20004902	8.9	36	39	2750	2250	0.393	0.51	0.25	202	6.1
3 x 70 + 3 x 35/3	20004901	10.6	41.2	44.2	3700	3150	0.277	0.59	0.24	250	8.54
3 x 95 + 3 x 50/3	20004900	12.1	45.7	48.7	4650	4275	0.21	0.6	0.24	301	11.59
3 x 120 + 3 x 70/3	20001453	14.1	48.7	52.7	5750	5400	0.164	0.69	0.23	352	14.64
3 x 150 + 3 x 70/3	20004899	16	55.7	59.7	7070	6750	0.132	0.7	0.23	404	18.3
3 x 185 + 3 x 95/3	20004905	17.8	60.4	64.4	8470	9200	0.108	0.71	0.23	461	22.57
3 x 240 + 3 x 120/3	20008903	20.2	68.2	72.2	10900	11500	0.0817	0.73	0.23	540	29.28

-45°C

Number of cores x cross section	Part number	Conductor diameter max. mm	Outer diameter min. mm	Outer diameter max. mm	Net weight approx. kg/km	Permissible tensile force max. N	Conductor resistance at 20°C max. Ω/km	Nom. operating capacitance μF/km	Inductance nom. mH/km	Current carrying capacity (1) A	Short Circuit Current (conductor) kA
3 x 16 + 3 x 2,5		5.4	24.4	27.4	1200	720	1240	0.42	0.26	99	1.95
3 x 25 + 3 x 4		6.3	28.2	31.2	1700	1125	0.795	0.42	0.26	131	3.05
3 x 35 + 3 x 16/3		7.5	30.5	33.5	2200	1575	0.565	0.49	0.25	162	4.27
3 x 50 + 3 x 25/3		8.9	36	39	2800	2250	0.393	0.51	0.25	202	6.1
3 x 70 + 3 x 35/3	20016544	10.6	41.2	44.2	3780	3150	0.277	0.59	0.24	250	8.54
3 x 95 + 3 x 50/3	20035936	12.1	45.7	48.7	4740	4275	0.21	0.6	0.24	301	11.59
3 x 120 + 3 x 70/3		14.1	48.7	52.7	5800	5400	0.164	0.69	0.23	352	14.64
3 x 150 + 3 x 70/3	20004907	16	55.7	59.7	7180	6750	0.132	0.7	0.23	404	18.3
3 x 185 + 3 x 95/3		17.8	60.4	64.4	8500	9200	0.108	0.71	0.23	461	22.57
3 x 240 + 3 x 120/3		20.2	65	71	11000	11500	0.0817	0.73	0.23	540	29.28

Opencast Mining

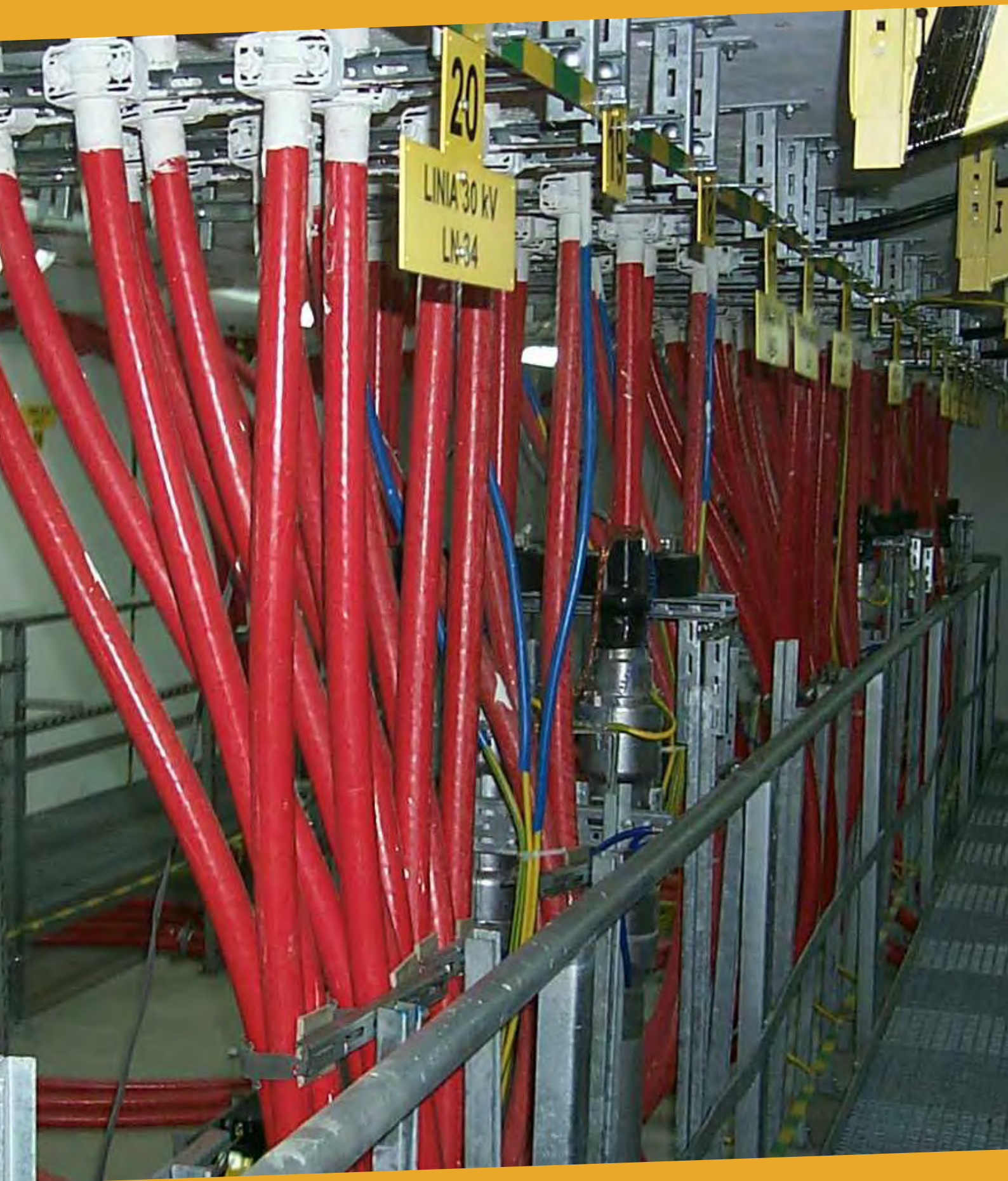

MEDIUM VOLTAGE SINGLE CORE CABLES

	FELTOFLEX NTMCW0EU	PROTOLON NTMCGCWOEU	PROTOLON(M) (N)TMCGCWOEU
Application	Flexible/semi-fixed	Flexible/semi-fixed	Flexible/semi-fixed
Voltage range	up to 150kV	up to 30kV	up to 30kV
Permissible tensile force	max. 15N/mm ²	max. 15N/mm ²	max. 15N/mm ²
Cable design	up to 35kV acc. to VDE; up to 150kV based on IEC 60840	acc. to VDE	based on VDE
Sheath against torsion	+/- 25°/m	+/- 25°/m	+/- 25°/m
Sheath quality	5GM5	5GM3	5GM3
Outer semiconductive layer	cold removable	warm removable	cold removable
Temperature range in fully flexible operation	-25°C to +80°C	-25°C to +60°C	-25°C to +60°C
Approvals	Fire certificate, Gost K, Gost B	Fire certificate, Gost K, Gost B,	Fire certificate, Gost K, Gost B

FELTOFLEX

Single-core medium and high voltage cable



Application

These cables are intended for use as connection in switch-gear or transformer houses where a very small bending radius is required. These cables may be used in festoon systems up to a speed of 120 m/min. The preferred case due to the flexibility of the cable are shiftable units, big drivers, mobile transformers etc.

Global data

Brand	FELTOFLEX
Type designation	NTMCW0EU
Standard	DIN VDE 0250-813
Certifications / Approvals	Fire Certificate of Russian Federation GOST K GOST B

Design features

Conductor	Copper tinned, finely stranded (class 5), according to DIN VDE 0295
Insulation	Rubber, compound type: EPR-3GI3
Electrical field control	Inner and outer layer of semiconductive rubber compound, cold strippable outer layer
Core identification	Acc. to DIN VDE 0250 P 813, Color: Natural
Screen	Spinning of tinned copper wires
Outer sheath	Rubber, compound type: 5GM5 acc. to DIN VDE 0207 part 21, Color: Red

Electrical parameters

Rated voltage	3.6/6 kV	6/10 kV	8.7/15 kV	12/20 kV	14/25 kV	18/30 kV	20/35 kV
Maximum permissible operating voltage AC	4.2/7.2 kV	6.9/12 kV	10.4/18 kV	13.9/24 kV	17.3/30 kV	20.8/36 kV	24.2/42 kV
Maximum permissible operating voltage DC	5.4/10.8 kV	9/18 kV	13.5/27 kV	18/36 kV	22.5/45 kV	27/54 kV	31.5/63 kV
AC test voltage	11 kV	17 kV	24 kV	29 kV	36 kV	43 kV	50 kV
	35/60 kV	64/110 kV	76/132 kV	89/155 kV			
	41.6/72 kV	76.2/132 kV	91.5/158.4 kV	107.4/186 kV			
	54/108 kV	99/198 kV	118.8/237.6 kV	139.5/279 kV			
	90 kV	160 kV	190 kV	218 kV			

Chemical parameters

Resistance to fire	EN 60332-1-2, IEC 60332-1-2
Resistance to oil	EN 60811-404, IEC 60811-404
Weather resistance	Unrestricted use outdoors and indoors, resistant to ozone, UV, and moisture

Thermal parameters

Max. permissible temperature at conductor	90 °C
Max. short circuit temperature of the conductor	250 °C
Ambient temperature for fix installation min.	-40 °C
Ambient temperature for fix installation max.	80 °C
Ambient temp. in fully flex. operation min.	-25 °C
Ambient temp. in fully flex. operation max.	80 °C

Mechanical parameters

Max. tensile load of cable	15 N/mm ²
Torsional stress	25 °/m
Bending radii min.	Acc. to DIN VDE 0298 part 3

Rated voltage 3.6/6 kV

Number of cores x cross section	Conductor diameter max. mm	Diameter over insulation (nom.) mm	Outer diameter min. mm	Outer diameter max. mm	Bending radius fixed min. mm	Bending radius free moving min. mm	Net weight approx. kg/km	Permissible tensile force max. N	Conductor resistance at 20°C max. Ω/km	Nom. operating capacitance μF/km	Current carrying capacity (1) A	Short Circuit Current (conductor) kA
1x25/16KON	6.2	14.6	19.1	21.6	129.6	216	750	375	0.795	0.24	178	3.58
1x35/16KON	7.5	15.9	20.4	22.9	137.4	229	850	525	0.565	0.27	220	5.01
1x50/16KON	9	17.36	21.8	24.3	145.8	243	1000	750	0.393	0.3	275	7.15
1x70/16KON	10.6	19	23.5	26	156	260	1250	1050	0.277	0.34	340	10.01
1x95/16KON	12.6	21	26.1	28.6	171.6	286	1500	1425	0.21	0.38	409	13.59
1x120/16KON	14.8	23.2	28.1	30.6	183.6	306	1800	1800	0.164	0.43	479	17.16
1x150/25KON	16	24.4	29.4	31.9	191.4	319	2150	2250	0.132	0.46	549	21.45
1x185/25KON	17.7	26.1	32.2	34.7	208.2	347	2550	2775	0.108	0.5	627	26.46
1x240/25KON	20.3	28.7	34.8	37.3	223.8	373	3100	3600	0.0817	0.56	744	34.32
1x300/25KON	22.5	30.9	38	40.5	243	405	3750	4500	0.0654	0.61	861	42.9

Rated voltage 6/10 kV

Number of cores x cross section	Part number	Conductor diameter max. mm	Outer diameter min. mm	Outer diameter max. mm	Net weight approx. kg/km	Permissible tensile force max. N	Conductor resistance at 20°C max. Ω/km	Nom. operating capacitance μF/km	Inductance nom. mH/km	Current carrying capacity (1) A	Short Circuit Current (conductor) kA
3x25+3x25/3	20004612	6.4	34.9	37.9	2120	1125	0.78	0.31	0.33	131	3.58
3x35+3x25/3	20004615	7.6	38.4	41.4	2610	1575	0.554	0.35	0.32	162	5.01
3x50+3x25/3	20007428	9.1	41.6	44.6	3230	2250	0.386	0.4	0.3	202	7.15
3x70+3x35/3	20004639	10.8	45.2	48.2	4080	3150	0.272	0.46	0.29	250	10.01
3x95+3x50/3	20004641	12.7	50.4	54.4	5310	4275	0.206	0.52	0.27	301	13.6
3x120+3x70/3	20004619	14.3	54.4	58.4	6410	5400	0.161	0.57	0.27	352	17.16
3x150+3x70/3	20004642	16	57.9	61.9	7450	6750	0.129	0.63	0.26	404	21.45
3x185+3x95/3	20004643	17.7	62.5	66.5	8940	8325	0.106	0.68	0.25	462	26.46

Rated voltage 8.7/15 kV

Number of cores x cross section	Conductor diameter max. mm	Diameter over insulation (nom.) mm	Outer diameter min. mm	Outer diameter max. mm	Bending radius fixed min. mm	Bending radius free moving min. mm	Net weight approx. kg/km	Permissible tensile force max. N	Conductor resistance at 20°C max. Ω/km	Nom. operating capacitance μF/km	Current carrying capacity (1) A	Short Circuit Current (conductor) kA
1x25/16KON	6.2	20	24.6	27.1	162.6	271	1000	375	0.795	0.16	189	3.58
1x35/16KON	7.5	21.3	25.9	28.4	170.4	284	1150	525	0.565	0.18	234	5.01
1x50/16KON	9	22.9	27.3	29.8	178.8	298	1350	750	0.393	0.2	294	7.15
1x70/16KON	10.6	24.7	31.1	33.6	201.6	336	1650	1050	0.277	0.22	360	10.01
1x95/16KON	12.6	26.5	32	34.5	207	345	1900	1425	0.21	0.25	434	13.59
1x120/16KON	14.8	28.4	34.2	36.7	220.2	367	2200	1800	0.164	0.28	505	17.16
1x150/25KON	16	30.1	36.5	39	234	390	2700	2250	0.132	0.29	582	21.45
1x185/25KON	17.7	31.9	38.3	40.8	244.8	408	3050	2775	0.108	0.31	664	26.46
1x240/25KON	20.3	34	40.9	43.4	260.4	434	3600	3600	0.0817	0.36	782	34.32
1x300/25KON	22.5	35.2	43.1	45.6	273.6	456	4200	4500	0.0654	0.41	898	42.9
1x400/35KON	26.5	39.1	47	50	300	500	4620	6000	0.05	0.47	1088	57.2

Rated voltage 12/20 kV

Number of cores x cross section	Part number	Conductor diameter max. mm	Diameter over insulation (nom.) mm	Outer diameter min. mm	Outer diameter max. mm	Bending radius fixed min. mm	Bending radius free moving min. mm	Net weight approx. kg/km	Permissible tensile force max. N	Conductor resistance at 20°C max. Ω/km	Nom. operating capacitance μF/km	Current carrying capacity (1) A	Short Circuit Current (conductor) kA
1x25/16KON	20091155	6.2	20	26.4	28.9	173.4	289	1100	375	0.795	0.16	189	3.58
1x35/16KON	20074729	7.5	21.3	27.6	30.1	180.6	301	1250	525	0.565	0.18	234	5.01
1x50/16KON	20074260	9	22.9	29.3	31.8	190.8	318	1450	750	0.393	0.2	294	7.15
1x70/16KON	20074256	10.6	24.7	33.5	36	216	360	1800	1050	0.277	0.22	360	10.01
1x95/16KON	20074253	12.6	26.5	34.6	37.1	222.6	371	2050	1425	0.21	0.25	434	13.59
1x120/16KON	20074727	14.8	28.4	36.4	38.9	233.4	389	2350	1800	0.164	0.28	505	17.16
1x150/25KON	20074259	16	30.1	38.9	41.4	248.4	414	2900	2250	0.132	0.29	582	21.45
1x185/25KON	20143211	17.7	31.9	40.1	42.6	255.6	426	3200	2775	0.108	0.31	664	26.46
1x240/25KON	20074267	20.3	34	43.3	45.8	274.8	458	3850	3600	0.0817	0.36	782	34.32
1x300/25KON	20087237	22.5	35.2	44.9	47.4	284.4	474	4400	4500	0.0654	0.41	898	42.9
1x400/35KON	20140653	26.5	39.1	48	52	312	520	6100	6000	0.05	0.47	1088	57.2
1x500/35KON	20142780	29.3	41.9	52	56	336	560	7010	7500	0.0391	0.51	1224	71.5
1x500/70KON		29.3	41.9	52	56	336	560	7480	7500	0.0391	0.51	1224	71.5

Rated voltage 14/25 kV

Number of cores x cross section	Conductor diameter max. mm	Diameter over insulation (nom.) mm	Outer diameter min. mm	Outer diameter max. mm	Bending radius fixed min. mm	Bending radius free moving min. mm	Net weight approx. kg/km	Permissible tensile force max. N	Conductor resistance at 20°C max. Ω/km	Nom. operating capacitance μF/km	Current carrying capacity (1) A	Short Circuit Current (conductor) kA
1x25/16KON	6.2	21.4	29.2	31.7	190.2	317	1300	375	0.795	0.15	189	3.58
1x35/16KON	7.5	23.5	31.5	34	204	340	1500	525	0.565	0.16	234	5.01
1x50/16KON	9	24.96	32.9	35.4	212.4	354	1700	750	0.393	0.18	294	7.15
1x70/16KON	10.6	26.6	34.6	37.1	222.6	371	1950	1050	0.277	0.2	360	10.01
1x95/16KON	12.6	28.6	37.6	40.1	240.6	401	2300	1425	0.21	0.22	434	13.59
1x120/16KON	14.8	30.8	39.8	42.3	253.8	423	2650	1800	0.164	0.25	505	17.16
1x150/25KON	16	32	41.1	43.6	261.6	436	3050	2250	0.132	0.26	582	21.45
1x185/25KON	17.7	33.7	42.9	45.4	272.4	454	3450	2775	0.108	0.28	664	26.46
1x240/25KON	20.3	36.3	45.5	48	288	480	4050	3600	0.0817	0.31	782	34.32
1x300/25KON	22.5	38.8	48.7	51.2	307.2	512	4800	4500	0.0654	0.33	898	42.9
1x400/35KON	26.5	41.3	49.2	53.2	319.2	532	5300	6000	0.05	0.41	1088	57.2
1x500/35KON	29.3	44.1	52	56	336	560	5500	7500	0.0391	0.44	1224	71.5
1x630/35KON	33.9	48.7	56.6	60.6	363.6	606	5800	9450	0.0292	0.5	1360	90.09

Rated voltage 18/30 kV

Number of cores x cross section	Conductor diameter max. mm	Diameter over insulation (nom.) mm	Outer diameter min. mm	Outer diameter max. mm	Bending radius fixed min. mm	Bending radius free moving min. mm	Net weight approx. kg/km	Permissible tensile force max. N	Conductor resistance at 20°C max. Ω/km	Nom. operating capacitance μF/km	Current carrying capacity (1) A	Short Circuit Current (conductor) kA
1x25/16KON	6.2	24.6	32.4	34.9	209.4	349	1500	375	0.795	0.14	189	3.58
1x35/16KON	7.5	25.9	33.7	36.2	217.2	362	1650	525	0.565	0.15	234	5.01
1x50/16KON	9	26.5	35.1	37.6	225.6	376	1850	750	0.393	0.17	294	7.15
1x70/16KON	10.6	29	37.8	40.3	241.8	403	2200	1050	0.277	0.18	360	10.01
1x95/16KON	12.6	31	39.8	42.3	253.8	423	2500	1425	0.21	0.2	434	13.59
1x120/16KON	14.8	33.2	42	44.5	267	445	2850	1800	0.164	0.22	505	17.16
1x150/25KON	16	34.6	43.5	46	276	460	3300	2250	0.132	0.23	582	21.45
1x185/25KON	17.7	36	45.1	47.6	285.6	476	3650	2775	0.108	0.25	664	26.46
1x240/25KON	20.3	38.7	48.7	51.2	307.2	512	4400	3600	0.0817	0.28	782	34.32
1x300/25KON	22.5	42.5	50.9	54.4	326.4	544	5050	4500	0.065	0.28	898	42.9
1x500/35KON	29.3	47.7	54	58	348	580	8150	7500	0.0391	0.37	1224	71.5
1x630/35KON	36.2	53.4	62	66	396	660	9250	9450	0.0292	0.46	1360	90.09

Rated voltage 20/35 kV

Number of cores x cross section	Conductor diameter max. mm	Diameter over insulation (nom.) mm	Outer diameter min. mm	Outer diameter max. mm	Bending radius fixed min. mm	Bending radius free moving min. mm	Net weight approx. kg/km	Permissible tensile force max. N	Conductor resistance at 20°C max. Ω/km	Nom. operating capacitance μF/km	Current carrying capacity (1) A	Short Circuit Current (conductor) kA
1x95/16KON	12.9	33.4	41	44	264	440	2900	1425	0.210	0.19	434	13.59
1x150/25KON	16.2	36.4	43.3	46.3	277.8	463	3600	2250	0.132	0.22	582	21.45
1x240/25KON	20.6	40.8	47.7	51.7	310.2	517	5000	3600	0.0817	0.26	782	34.32

Rated voltage 35/60 kV

Number of cores x cross section	Conductor diameter max. mm	Diameter over insulation (nom.) mm	Outer diameter min. mm	Outer diameter max. mm	Bending radius fixed min. mm	Bending radius free moving min. mm	Net weight approx. kg/km	Permissible tensile force max. N	Conductor resistance at 20°C max. Ω/km	Nom. operating capacitance μF/km	Current carrying capacity (1) A	Short Circuit Current (conductor) kA
1x25/16KON	6.2	30.2	41.3	43.8	262.8	438	2100	375	0.795	0.13	160	3.58
1x35/16KON	7.5	31.5	42.6	45.1	270.6	451	2250	525	0.565	0.14	200	5.01
1x50/16KON	9	32.96	44.3	46.8	280.8	468	2550	750	0.393	0.15	245	7.15
1x70/16KON	10.6	34.6	45.9	48.4	290.4	484	2850	1050	0.277	0.16	305	10.01
1x95/16KON	12.6	36.6	47.9	50.4	302.4	504	3150	1425	0.21	0.18	360	13.59
1x120/16KON	14.8	37.8	49.1	51.6	309.6	516	3450	1800	0.164	0.21	425	17.16
1x150/25KON	16	39	50.5	54	324	540	3850	2250	0.132	0.22	475	21.45
1x185/25KON	17.7	40.7	53.2	56.7	340.2	567	4400	2775	0.108	0.23	530	26.46
1x240/25KON	20.3	42.3	54.8	58.3	349.8	583	4950	3600	0.0817	0.26	625	34.32
1x300/25KON	22.5	44.5	57.2	60.7	364.2	607	5600	4500	0.065	0.28	710	42.9

Rated voltage 64/110 kV

Number of cores x cross section	Conductor diameter max. mm	Diameter over insulation (nom.) mm	Outer diameter min. mm	Outer diameter max. mm	Bending radius fixed min. mm	Bending radius free moving min. mm	Net weight approx. kg/km	Permissible tensile force max. N	Conductor resistance at 20°C max. Ω/km	Nom. operating capacitance μF/km	Current carrying capacity (1) A	Short Circuit Current (conductor) kA
1x120/85KON	14.8	50.8	64.7	68.2	409.2	682	5750	1800	0.164	0.15	390	17.16
1x150/85KON	16	51	64.9	68.4	410.4	684	5950	2250	0.132	0.16	435	21.45
1x185/85KON	17.7	51.7	65.6	69.1	414.6	691	6300	2775	0.108	0.17	485	26.46
1x240/85KON	20.3	53.3	67.2	70.7	424.2	707	6900	3600	0.0817	0.19	560	34.32
1x300/85KON	22.5	55.5	70.6	74.1	444.6	741	7800	4500	0.0654	0.2	620	42.9
1x400/85KON	25.5	58.5	77.6	81.1	486.6	811	8900	6000	0.05	0.22	705	57.2
1x500/85KON	29.5	62.5	82.6	86.1	516.6	861	10200	7500	0.0391	0.24	785	71.5
1x630/85KON	33.5	66.5	86.6	90.1	540.6	901	12250	9450	0.0292	0.27	870	90.09
1x800/85KON	39.2	72.2	93.3	96.8	580.8	968	14750	12000	0.03	0.3	965	114.4

Rated voltage 76/132 kV

Number of cores x cross section	Part number	Conductor diameter max. mm	Diameter over insulation (nom.) mm	Outer diameter min. mm	Outer diameter max. mm	Bending radius fixed min. mm	Bending radius free moving min. mm	Net weight approx. kg/km	Permissible tensile force max. N	Conductor resistance at 20°C max. Ω/km	Nom. operating capacitance μF/km	Current carrying capacity (1) A	Short Circuit Current (conductor) kA
1x120/85KON	20160911	14.8	60.8	75.9	79.4	476.4	794	7400	1800	0.164	0.13	380	17.16
1x150/85KON		16	60	75.1	78.6	471.6	786	7400	2250	0.132	0.14	430	21.45
1x185/85KON		17.7	59.7	74.8	78.3	469.8	783	7600	2775	0.108	0.15	475	26.46
1x240/85KON	20111612	20.3	59.3	74.4	77.9	467.4	779	7900	3600	0.0817	0.17	555	34.32
1x300/85KON		22.5	60.5	75.8	79.3	475.8	793	8250	4500	0.0654	0.19	620	42.9
1x400/85KON		25.5	62.5	77.6	81.1	486.6	811	9500	6000	0.05	0.2	700	57.2
1x500/85KON		29.5	66.5	82.6	86.1	516.6	861	11000	7500	0.0391	0.22	775	71.5
1x630/85KON		33.5	70.5	86.6	90.1	540.6	901	12950	9450	0.0292	0.24	870	90.09
1x800/85KON		39.2	76.2	93.3	96.8	580.8	968	15650	12000	0.03	0.27	955	114.4

Rated voltage 89/155 kV

Number of cores x cross section	Part number	Conductor diameter max. mm	Diameter over insulation (nom.) mm	Outer diameter min. mm	Outer diameter max. mm	Bending radius fixed min. mm	Bending radius free moving min. mm	Net weight approx. kg/km	Permissible tensile force max. N	Conductor resistance at 20°C max. Ω /km	Nom. operating capacitance μ F/km	Current carrying capacity (1) A	Short Circuit Current (conductor) kA
1x240/85KON		20.3	68.3	84.2	87.7	526.2	877	9900	3600	0.0817	0.15	545	34.32
1x300/85KON		22.5	68.5	84.6	88.1	528.6	881	10100	4500	0.0654	0.16	610	42.9
1x400/85KON		25.5	69.5	85.4	88.9	533.4	889	10900	6000	0.05	0.18	695	57.2
1x500/85KON		29.5	72.5	88.4	91.9	551.4	919	12100	7500	0.0391	0.2	775	71.5
1x630/85KON	20091978	33.5	75.5	92.4	95.9	575.4	959	14150	9450	0.0292	0.22	860	90.09
1x800/85KON	20091979	39.2	79.2	96.3	99.8	598.8	998	16800	12000	0.03	0.26	950	114.4

PROTOLON NTMCGCWOEU

Medium voltage flexible single-core cable acc. to VDE 0250 part 813



Application

In general single-core cables are used in short lengths e.g. for the connection of switchgear cubicles and for connection of mobile transformer substations to overhead lines. While laying and during operation, care should be taken to protect the cables against excessive mechanical stresses. Furthermore the general conditions in DIN VDE 0298-3 have to be applied.

Global data

Brand	PROTOLON
Type	PROTOLON NTMCGCWOEU
Standard	DIN VDE 0250-813
Certifications / Approvals	Fire Certificate of Russian Federation GOST K GOST B

Notes on installation

Notes on installation Suitable material sets for self-assembly or termination at manufacturers factory workshop.

Design features

Conductor	Finely stranded copper conductor, tinned (class 5), acc. DIN VDE 0295/ IEC 60228
PE-Conductor	Spinning with tinned copper wires 16 mm ² or 25 mm ²
Insulation	PROTOLON, Basic material: EPR, Compound type: 3GI3, acc. DIN VDE 0207 Part 20
Electrical field control	Inner and outer layer of semiconductive rubber compound
Outer sheath	Special compound, Basic material: Chlorinated rubber, Compound type: 5GM3, Color: Red, acc. DIN VDE 0207 Part 21

Electrical parameters

Rated voltage	3.6/6 kV	6/10 kV	8.7/15 kV	12/20 kV	14/25 kV	18/30 kV
Maximum permissible operating voltage AC	4.2/7.2 kV	6.9/12 kV	10.4/18 kV	13.9/24 kV	17.3/30 kV	20.8/36 kV
Maximum permissible operating voltage DC	5.4/10.8 kV	9/18 kV	13.5/27 kV	18/36 kV	22.5/45 kV	27/54 kV
AC test voltage	11 kV	17 kV	24 kV	29 kV	36 kV	43 kV

Chemical parameters

Resistance to fire	EN 60332-1-2, IEC 60332-1-2
Resistance to oil	EN 60811-404, IEC 60811-404
Weather resistance	Unrestricted use outdoors and indoors, resistant to ozone, UV, and moisture

Thermal parameters

Max. permissible temperature at conductor	90 °C
Max. short circuit temperature of the conductor	250 °C
Ambient temperature for fix installation min.	-40 °C
Ambient temperature for fix installation max.	80 °C
Ambient temp. in fully flex. operation min.	-25 °C
Ambient temp. in fully flex. operation max.	60 °C

Mechanical parameters

Tensile load on the conductor max .	15 N/mm ²
Torsional stress	25 %/m

Rated voltage 3.6/6 kV

Number of cores x cross section	Part number	Conductor diameter max. mm	Diameter over insulation (nom.) mm	Outer diameter min. mm	Outer diameter max. mm	Bending radius fixed min. mm	Bending radius free moving min. mm	Net weight approx. kg/km	Permissible tensile force max. N	Conductor resistance at 20°C max. Ω/km	Nom. operating capacitance μF/km	Current carrying capacity (1) A	Short Circuit Current (conductor) kA
1x25/16KON		6.4	14	20.6	22.1	132.6	221	820	375	0.795	0.26	178	3.58
1x35/16KON		7.5	15.1	21.5	23	138	230	930	525	0.565	0.29	220	5.01
1x50/16KON		9	16.6	23	24.5	147	245	1110	750	0.393	0.33	275	7.15
1x70/16KON		10.8	18.4	25.1	27.4	164.4	274	1380	1050	0.277	0.38	340	10.01
1x95/16KON		12.6	20.2	26.9	29.2	175.2	292	1630	1425	0.21	0.42	409	13.59
1x120/16KON	20001442	14.2	21.8	28.5	30.8	184.8	308	1900	1800	0.164	0.46	479	17.16
1x150/25KON	20004502	15.8	23.4	31.9	34.1	204.6	341	2360	2250	0.132	0.5	549	21.45
1x185/25KON	20004503	17.4	25	33.5	35.7	214.2	357	2700	2775	0.108	0.54	627	26.46
1x240/25KON	20001441	20.4	28.3	37.5	39.7	238.2	397	3430	3600	0.0817	0.6	744	34.32
1x300/25KON	20004504	22.9	30.5	40	42.2	253.2	422	3920	4500	0.0641	0.68	861	42.9

(1): According to DIN VDE 0298, Part 4

Rated voltage 6/10 kV

Number of cores x cross section	Part number	Conductor diameter max. mm	Diameter over insulation (nom.) mm	Outer diameter min. mm	Outer diameter max. mm	Bending radius fixed min. mm	Bending radius free moving min. mm	Net weight approx. kg/km	Permissible tensile force max. N	Conductor resistance at 20°C max. Ω/km	Nom. operating capacitance μF/km	Current carrying capacity (1) A	Short Circuit Current (conductor) kA
1x25/16KON	20004567	6.4	14.8	21.2	22.7	136.2	227	860	375	0.795	0.24	178	3.58
1x35/16KON	20004559	7.5	15.9	22.3	23.8	142.8	238	960	525	0.565	0.27	220	5.01
1x50/16KON	20004560	9	17.4	23.8	25.3	151.8	253	1140	750	0.393	0.3	275	7.15
1x70/16KON	20004561	10.8	19.2	25.9	28.2	169.2	282	1410	1050	0.277	0.34	340	10.01
1x95/16KON	20004562	12.6	21	27.7	30	180	300	1660	1425	0.21	0.38	409	13.59
1x120/16KON	20004563	14.2	22.6	30.3	32.6	195.6	326	2010	1800	0.164	0.42	479	17.16
1x150/25KON	20004565	15.8	24.2	32.7	34.9	209.4	349	2410	2250	0.132	0.46	549	21.45
1x185/25KON	20057165	17.4	25.8	34.3	36.5	219	365	2800	2775	0.108	0.49	627	26.46
1x240/25KON	20004566	20.4	29.1	38.3	40.5	243	405	3430	3600	0.0817	0.54	744	34.32

(1): According to DIN VDE 0298, Part 4

Rated voltage 8.7/15 kV

Number of cores x cross section	Part number	Conductor diameter max. mm	Diameter over insulation (nom.) mm	Outer diameter min. mm	Outer diameter max. mm	Bending radius fixed min. mm	Bending radius free moving min. mm	Net weight approx. kg/km	Permissible tensile force max. N	Conductor resistance at 20°C max. Ω/km	Nom. operating capacitance μF/km	Current carrying capacity (1) A	Short Circuit Current (conductor) kA
1x25/16KON	20004680	6.4	17	23.4	24.9	149.4	249	950	375	0.795	0.2	189	3.58
1x35/16KON		7.5	18.1	24.9	27.1	162.6	271	1110	525	0.565	0.22	234	5.01
1x50/16KON		9	19.6	26.4	28.6	171.6	286	1300	750	0.393	0.25	294	7.15
1x70/16KON		10.8	21.4	28.1	30.4	182.4	304	1550	1050	0.288	0.28	360	10.01
1x95/16KON		12.6	23.2	30.9	33.2	199.2	332	1880	1425	0.21	0.31	434	13.59
1x120/16KON	20042544	14.2	24.8	32.5	34.8	208.8	348	2170	1800	0.164	0.34	505	17.16
1x150/25KON	20092201	15.8	26.4	34.9	37.1	222.6	371	2600	2250	0.132	0.37	582	21.45
1x185/25KON	20067340	17.4	28	37.5	39.7	238.2	397	3030	2775	0.108	0.4	664	26.46
1x240/25KON	20004677	20.4	31	40.5	42.7	256.2	427	3620	3600	0.0817	0.45	782	34.32
1x300/25KON	20004678	22.9	34.7	45	48	288	480	4460	4500	0.0654	0.27	898	42.9
1 x 400/35KON	20025956			45.2	48.2			5200				1085	57.23

(1): According to DIN VDE 0298, Part 4

Rated voltage 12/20 kV

Number of cores x cross section	Part number	Conductor diameter max. mm	Diameter over insulation (nom.) mm	Outer diameter min. mm	Outer diameter max. mm	Bending radius fixed min. mm	Bending radius free moving min. mm	Net weight approx. kg/km	Permissible tensile force max. N	Conductor resistance at 20°C max. Ω/km	Nom. operating capacitance μF/km	Current carrying capacity (1) A	Short Circuit Current (conductor) kA
1x25/16KON	20004710	6.4	19	25.7	28	168	280	1100	375	0.795	0.18	189	3.58
1x35/16KON	20004711	7.5	20.1	26.8	29.1	174.6	291	1230	525	0.565	0.19	234	5.01
1x50/16KON	20004712	9	21.6	28.3	30.6	183.6	306	1430	750	0.393	0.22	294	7.15
1x70/16KON	20004713	10.8	23.4	31.1	33.4	200.4	334	1760	1050	0.277	0.24	360	10.01
1x95/16KON	20004714	12.6	25.2	32.9	35.2	211.2	352	2030	1425	0.21	0.27	434	13.59
1x120/16KON	20037708	14.2	26.8	34.5	36.8	220.8	368	2320	1800	0.164	0.29	505	17.16
1x150/25KON		15.8	28.4	37.9	40.1	240.6	401	2820	2250	0.132	0.32	582	21.45
1x185/25KON	20004716	17.4	30	39.5	41.7	250.2	417	3180	2775	0.108	0.34	664	26.46
1x240/25KON	20004717	20.4	33	42.5	44.7	268.2	447	3810	3600	0.0817	0.39	782	34.32
1x300/25KON	20004678	22.9	34.7	45	48	288	480	4460	4500	0.0654	0.27	898	42.9

(1): According to DIN VDE 0298, Part 4

Rated voltage 14/25 kV

Number of cores x cross section	Part number	Conductor diameter max. mm	Diameter over insulation (nom.) mm	Outer diameter min. mm	Outer diameter max. mm	Bending radius fixed min. mm	Bending radius free moving min. mm	Net weight approx. kg/km	Permissible tensile force max. N	Conductor resistance at 20°C max. Ω/km	Nom. operating capacitance μF/km	Current carrying capacity (1) A	Short Circuit Current (conductor) kA
1x25/16KON		6.4	21.6	28.3	30.6	183.6	306	1250	375	0.795	0.16	189	3.58
1x35/16KON		7.5	22.7	30.4	32.7	196.2	327	1470	525	0.565	0.17	234	5.01
1x50/16KON		9	24.2	31.9	34.2	205.2	342	1680	750	0.393	0.19	294	7.15
1x70/16KON		10.8	26	33.7	36	216	360	1950	1050	0.277	0.21	360	10.01
1x95/16KON	20004737	12.6	27.8	36.5	38.8	232.8	388	2320	1425	0.21	0.23	434	13.59
1x120/16KON		14.2	29.4	38.1	40.4	242.4	404	2620	1800	0.164	0.25	505	17.16
1x150/25KON		15.8	31	40.5	42.7	256.2	427	3050	2250	0.132	0.27	582	21.45
1x185/25KON		17.4	32.6	42.1	44.3	265.8	443	3420	2775	0.108	0.29	664	26.46
1x240/25KON		20.4	35.6	45.1	47.3	283.8	473	4070	3600	0.0817	0.33	782	34.32
1x300/25KON	20024422	22.9	38.1	48.6	50.8	304.8	508	4850	4500	0.0654	0.36	898	42.9

(1): According to DIN VDE 0298, Part 4

Rated voltage 18/30 kV

Number of cores x cross section	Part number	Conductor diameter max. mm	Diameter over insulation (nom.) mm	Outer diameter min. mm	Outer diameter max. mm	Bending radius fixed min. mm	Bending radius free moving min. mm	Net weight approx. kg/km	Permissible tensile force max. N	Conductor resistance at 20°C max. Ω/km	Nom. operating capacitance μF/km	Current carrying capacity (1) A	Short Circuit Current (conductor) kA
1x25/16KON		6.4	24	31.7	34	204	340	1500	375	0.795	0.14	189	3.58
1x35/16KON		7.5	25.1	32.8	35.1	210.6	351	1600	525	0.565	0.15	234	5.01
1x50/16KON		9	26.6	34.4	36.6	219.6	366	1860	750	0.393	0.17	294	7.15
1x70/16KON		10.8	28.4	37.1	39.4	236.4	394	2230	1050	0.277	0.19	360	10.01
1x95/16KON	20004749	12.6	30.2	38.9	41.2	247.2	412	2530	1425	0.21	0.21	434	13.59
1x120/16KON		14.2	31.8	40.5	42.8	256.8	428	2840	1800	0.164	0.23	505	17.16
1x150/25KON		15.8	33.4	42.9	45.1	270.6	451	3280	2250	0.132	0.24	582	21.45
1x185/25KON		17.4	35	44.5	46.7	280.2	467	3650	2775	0.108	0.26	664	26.46
1x240/25KON	20016646	20.4	38	48.5	50.7	304.2	507	4430	3600	0.0817	0.29	782	34.32
1x300/25KON		22.9	40.5	50.7	53.7	322.2	537	5100	4500	0.0654	0.32	898	42.9

(1): According to DIN VDE 0298, Part 4

PROTOLON (M) NTMCGCWOEU

Medium voltage flexible single-core cable based on DIN VDE 0250 part 813 with optimized insulation wall-thickness



Application

In general single-core cables are used in short length e.g. for connection of switchgear cubicles and for connection of mobile transformer substations to the overhead lines. While laying and during operation care should be taken to protect the cables against excessive mechanical stresses. Furthermore the general conditions in DIN VDE 0298-3 have to be applied.

Global data

Brand	PROTOLON(M)
Type	(N)TMCGCWOEU
Standard	Based on DIN VDE 0250-813
Certifications / Approvals	Fire Certificate of Russian Federation GOST K GOST B

Notes on installation

Notes on installation Suitable material sets for self-assembly or termination at manufacturers factory workshop.

Design features

Conductor	Finely stranded copper conductor, tinned (class 5), acc. DIN VDE 0295/ IEC 60228
PE-Conductor	Spinning with tinned copper wires, 16mm ² or 25mm ²
Insulation	PROTOLON, Basic material: EPR, Compound type: Special compound better 3GI3
Electrical field control	Inner and outer layer of semiconductive rubber compound, cold strippable outer layer
Outer sheath	Special compound, Basic material: Chlorinated rubber, Compound type: 5GM3, Color: Red

Electrical parameters

Rated voltage	3.6/6 kV	6/10 kV	8.7/15 kV	12/20 kV	14/25 kV	18/30 kV
Maximum permissible operating voltage AC	4.2/7.2 kV	6.9/12 kV	10.4/18 kV	13.9/24 kV	17.3/30 kV	20.8/36 kV
Maximum permissible operating voltage DC	5.4/10.8 kV	9/18 kV	13.5/27 kV	18/36 kV	22.5/45 kV	27/54 kV
AC test voltage	11 kV	17 kV	24 kV	29 kV	36 kV	43 kV

Chemical parameters

Resistance to fire	EN 60332-1-2, IEC 60332-1-2
Resistance to oil	Given according EN 60811-404
Weather resistance	Unrestricted use outdoors and indoors, resistant to ozone, UV, and moisture

Thermal parameters

Max. permissible temperature at conductor	90 °C
Max. short circuit temperature of the conductor	250 °C
Ambient temperature for fix installation min.	-40 °C
Ambient temperature for fix installation max.	80 °C
Ambient temp. in fully flex. operation min.	-25 °C
Ambient temp. in fully flex. operation max.	60 °C

Mechanical parameters

Max. tensile load of cable	15 N/mm ²
Tensile load on the conductor max .	15 N/mm ²
Torsional stress	25 °/m
Bending radii min.	Acc. to DIN VDE 0298 part 3

Rated voltage 3.6/6 kV

Number of cores x cross section	Part number	Conductor diameter max. mm	Diameter over insulation (nom.) mm	Outer diameter min. mm	Outer diameter max. mm	Bending radius fixed min. mm	Bending radius free moving min. mm	Net weight approx. kg/km	Permissible tensile force max. N	Conductor resistance at 20°C max. Ω/km	Nom. operating capacitance μF/km	Current carrying capacity (1) A	Short Circuit Current (conductor) kA
1x25/16KON		6.4	12.2	18.8	20.3	121.8	203	710	375	0.795	0.33	178	3.58
1x35/16KON		7.5	13.3	19.9	21.4	128.4	214	820	525	0.565	0.37	220	5.01
1x50/16KON		9	14.8	21.2	22.7	136.2	227	990	750	0.393	0.43	275	7.15
1x70/16KON		10.8	16.6	23	24.5	147	245	1210	1050	0.277	0.49	340	10.01
1x95/16KON		12.6	18.4	25.1	27.4	164.4	274	1490	1425	0.21	0.55	409	13.59
1x120/16KON		14.2	20	26.7	29	174	290	1750	1800	0.164	0.61	476	17.16
1x150/25KON		15.8	21.6	29.1	31.3	187.8	313	2150	2250	0.132	0.66	549	21.45
1x185/25KON		17.4	23.2	31.7	33.9	203.4	339	2540	2775	0.108	0.72	627	26.46
1x240/25KON		20.4	26.2	34.7	36.9	221.4	369	3120	3600	0.0817	0.82	744	34.32
1x300/25KON		22.9	28.7	38.2	40.4	242.4	404	3780	4500	0.0641	0.91	861	42.9

(1): According to DIN VDE 0298, Part 4.

Rated voltage 6/10 kV

Number of cores x cross section	Conductor diameter max. mm	Diameter over insulation (nom.) mm	Outer diameter min. mm	Outer diameter max. mm	Bending radius fixed min. mm	Bending radius free moving min. mm	Net weight approx. kg/km	Permissible tensile force max. N	Conductor resistance at 20°C max. Ω/km	Nom. operating capacitance μF/km	Current carrying capacity (1) A	Short Circuit Current (conductor) kA
1x25/16KON	6.4	12.2	19.4	20.9	125.4	209	720	375	0.795	0.33	189	3.58
1x35/16KON	7.5	13.9	20.5	22	132	220	850	525	0.565	0.34	234	5.01
1x50/16KON	9	15.4	21.8	23.3	139.8	233	1020	750	0.393	0.39	294	7.15
1x70/16KON	10.8	17.2	23.6	25.1	150.6	251	1240	1050	0.277	0.44	360	10.01
1x95/16KON	12.6	19	25.7	28	168	280	1520	1425	0.21	0.5	434	13.59
1x120/16KON	14.2	20.6	27.3	29.6	177.6	296	1780	1800	0.164	0.55	505	17.16
1x150/25KON	15.8	22.2	30.7	32.9	197.4	329	2250	2250	0.132	0.6	582	21.45
1x185/25KON	17.4	23.79	32.3	34.5	207	345	2580	2775	0.108	0.65	664	26.46
1x240/25KON	20.4	26.79	35.3	37.5	225	375	3160	3600	0.0817	0.74	782	34.32
1x300/25KON	22.9	29.29	38.8	41	246	410	3830	4500	0.0641	0.82	1088	42.9

(1): According to DIN VDE 0298, Part 4.

Rated voltage 8.7/15 kV

Number of cores x cross section	Part number	Conductor diameter max. mm	Diameter over insulation (nom.) mm	Outer diameter min. mm	Outer diameter max. mm	Bending radius fixed min. mm	Bending radius free moving min. mm	Net weight approx. kg/km	Permissible tensile force max. N	Conductor resistance at 20°C max. Ω/km	Nom. operating capacitance μF/km	Current carrying capacity (1) A	Short Circuit Current (conductor) kA
1x25/16KON		6.4	14.4	21	22.5	135	225	800	375	0.795	0.25	189	3.58
1x35/16KON		7.5	15.5	21.9	23.4	140.4	234	920	525	0.565	0.28	234	5.01
1x50/16KON		9	17	23.4	24.9	149.4	249	1090	750	0.393	0.31	294	7.15
1x70/16KON		10.8	18.8	25.5	27.8	166.8	278	1360	1050	0.277	0.36	360	10.01
1x95/16KON		12.6	20.6	27.3	29.6	177.6	296	1610	1425	0.21	0.4	434	13.59
1x120/16KON		14.2	22.2	28.9	31.2	187.2	312	1880	1800	0.164	0.44	505	17.16
1x150/25KON		15.8	23.8	32.3	34.5	207	345	2360	2250	0.132	0.48	582	21.45
1x185/25KON		17.4	25.4	33.9	36.1	216.6	361	2690	2775	0.108	0.52	664	26.46
1x240/25KON	20007564	20.4	28.1	37.9	40.1	240.6	401	3360	3600	0.0817	0.61	782	34.32
1x300/25KON		22.9	30.9	40.4	42.6	255.6	426	3960	4500	0.0641	0.65	898	42.9

(1): According to DIN VDE 0298, Part 4.

Rated voltage 12/20 kV

Number of cores x cross section	Part number	Conductor diameter max. mm	Diameter over insulation (nom.) mm	Outer diameter min. mm	Outer diameter max. mm	Bending radius fixed min. mm	Bending radius free moving min. mm	Net weight approx. kg/km	Permissible tensile force max. N	Conductor resistance at 20°C max. Ω/km	Nom. operating capacitance μF/km	Current carrying capacity (1) A	Short Circuit Current (conductor) kA
1x25/16KON		6.4	15.8	22.2	23.7	142.2	237	860	375	0.795	0.22	189	3.58
1x35/16KON	20008239	7.5	16.3	23.3	24.8	148.8	248	980	525	0.565	0.26	234	5.01
1x50/16KON		9	18.4	25.1	27.4	164.4	274	1200	750	0.393	0.27	294	7.15
1x70/16KON		10.8	20.2	26.9	29.2	175.2	292	1440	1050	0.277	0.31	360	10.01
1x95/16KON		12.6	22	28.7	31	186	310	1690	1425	0.21	0.35	434	13.59
1x120/16KON	20016475	14.2	23.4	31.3	33.6	201.6	336	2030	1800	0.164	0.39	505	17.16
1x150/25KON		15.8	25.2	33.7	35.9	215.4	359	2450	2250	0.132	0.41	582	21.45
1x185/25KON		17.4	26.8	35.3	37.5	225	375	2790	2775	0.108	0.44	664	26.46
1x240/25KON	20067202	20.4	29.9	39.3	41.5	249	415	3470	3600	0.0817	0.5	782	34.32
1x300/25KON		22.9	32.3	41.8	44	264	440	4080	4500	0.0641	0.55	898	42.9

(1): According to DIN VDE 0298, Part 4.

Rated voltage 14/25 kV

Number of cores x cross section	Conductor diameter max. mm	Diameter over insulation (nom.) mm	Outer diameter min. mm	Outer diameter max. mm	Bending radius fixed min. mm	Bending radius free moving min. mm	Net weight approx. kg/km	Permissible tensile force max. N	Conductor resistance at 20°C max. Ω/km	Nom. operating capacitance μF/km	Current carrying capacity (1) A	Short Circuit Current (conductor) kA
1x25/16KON	6.4	17.6	24.3	26.6	159.6	266	980	375	0.795	0.19	189	3.58
1x35/16KON	7.5	18.7	25.4	27.7	166.2	277	1110	525	0.565	0.21	234	5.01
1x50/16KON	9	20.2	26.9	29.2	175.2	292	1290	750	0.393	0.24	294	7.15
1x70/16KON	10.8	22	28.7	31	186	310	1540	1050	0.277	0.27	360	10.01
1x95/16KON	12.6	23.8	31.5	33.8	202.8	338	1870	1425	0.21	0.3	434	13.59
1x120/16KON	14.2	25.4	33.1	35.4	212.4	354	2150	1800	0.164	0.33	505	17.16
1x150/25KON	15.8	27	36.5	38.7	232.2	387	2660	2250	0.132	0.35	582	21.45
1x185/25KON	17.4	28.6	38.1	40.3	241.8	403	3013	2775	0.108	0.38	664	26.46
1x240/25KON	20.4	31.6	41.1	43.3	259.8	433	3620	3600	0.0817	0.43	782	34.32
1x300/25KON	22.9	34.1	43.6	45.8	274.8	458	4230	4500	0.0641	0.47	898	42.9

(1): According to DIN VDE 0298, Part 4.

Rated voltage 18/30 kV

Number of cores x cross section	Part number	Conductor diameter max. mm	Diameter over insulation (nom.) mm	Outer diameter min. mm	Outer diameter max. mm	Bending radius fixed min. mm	Bending radius free moving min. mm	Net weight approx. kg/km	Permissible tensile force max. N	Conductor resistance at 20°C max. Ω/km	Nom. operating capacitance μF/km	Current carrying capacity (1) A	Short Circuit Current (conductor) kA
1x25/16KON		6.4	19.2	25.9	28.2	169.2	282	1070	375	0.795	0.18	189	3.58
1x35/16KON		7.5	20.3	27	29.3	175.8	293	1200	525	0.565	0.19	234	5.01
1x50/16KON		9	21.8	28.5	30.8	184.8	308	1390	750	0.393	0.21	294	7.15
1x70/16KON		10.8	23.6	31.3	33.6	201.6	336	1710	1050	0.277	0.24	360	10.01
1x95/16KON		12.6	25.4	33.1	35.4	212.4	354	1980	1425	0.21	0.27	434	13.59
1x120/16KON		14.2	27	34.7	37	222	370	2260	1800	0.164	0.29	505	17.16
1x150/25KON		15.8	28.6	38.1	40.3	241.8	403	2780	2250	0.132	0.31	582	21.45
1x185/25KON		17.4	30.2	39.7	41.9	251.4	419	3130	2775	0.108	0.34	664	26.46
1x240/25KON	20007565	20.4	32.9	42.7	44.9	269.4	449	3760	3600	0.0817	0.39	782	34.32
1x300/25KON		22.9	35.7	45.2	47.4	284.4	474	4380	4500	0.0641	0.42	898	42.9

(1): According to DIN VDE 0298, Part 4.

Opencast Mining



CONTROL AND SIGNALING CABLES

	OPTOFLEX(M)	PROTOMONT MSR	L-2YY(Z)Y-KF40
Application	semi-fixed	semi-fixed	semi-fixed
Permissible tensile force	max. 2000N	max. 15N/mm ²	max. 15N/mm ²
Cable design	Flexible fibre optic cable	Rubber sheathed data cable	PVC sheathed data cable
Special design features	Glass fibres in jelly filled tubes	Twisted pairs, overall screen	Twisted pairs steel braid
Sheath quality	5GM5	EM2	Cold flexible PVC
Reversed bending stability	++	++	++
Temperature range in fully flexible operation	-30°C to +60°C	-25°C to +60°C	-40°C to +50°C
Approvals		Fire certificate	Fire certificate

OPTOFLEX (M)

Rubber sheathed flexible fiber optic cables



OPTOFLEX(M) 6x2G50/125 MICRON

Application

For optical signal and data transmission in open-cast mining applications, for use on material handling equipment and for laying alongside conveyor belts (including shiftable conveyor belts).

Global data

Brand	OPTOFLEX(M)
Type designation	6 x ... x ... /125 Micron
Type designation	6 x ... /125 Micron
Standard	Based on FDDI
Standard	Based on DIN VDE 0888
Standard	ISO/IEC 9314-3
Certifications / Approvals	MSHA-SC 189-1

Design features

Core identification	Color coding of the fibers and buffering tube for identification of the fiber type		
Optical Fiber	Transmission data		
	Monomode fiber:	E9/125	
	Graded index:		50/125 62.5/125
	Attenuation at wavelength 850 nm:	-	2.8db/km 3.3db/km
	Attenuation at wavelength 1310 nm:	0.4db/km	0.8db/km 0.9db/km
	Attenuation at wavelength 1550 nm:	0.3db/km	- -
	Numerical aperture:	0.14±0.02	0.200±0.02 0.275±0.02
	Dispersion value at 1300nm:	<3.5 ps/nm km	
	Dispersion value at 1550nm:	<18 ps/nm km	
	Bandwith at 850 nm:		>=400 MHz >=400 MHz
	Bandwith at 1300 nm:		>1200 MHz >600 MHz
Optical Fiber	Fibre core diameter	9 µm	50 µm 62.5 µm
	Diameter across the cladding:	125 µm	125 µm 125 µm
	Diameter over the coating:	250 µm	250 µm 250 µm
Fiber covering	Hollow core with filling compound, Basic material: ETFE, Compound: 7YI 1, Natural color		
Core arrangement	Six buffering tubes, one layer, especially laid-up around a GRP supporting element (GRP= Glass-fiber reinforced plastic)		
Braid	Special braid of Kevlar threads, tensile-strength reinforcement by means of longitudinal Kevlar threads, Surface covered: approx. 80%		
Outer sheath	Basic material: synthetic elastomer compound e.g. CR, Compound type: 5GM5, Color: Orange		

Chemical parameters

Resistance to oil	EN 60811-404, IEC 60811-404
Weather resistance	Unrestricted use outdoors and indoors, resistant to ozone, UV and moisture
Water resistance	EN 50525-2-21

Mechanical parameters

Max. tensile load	2000 N
Torsional stress	100 °/m
Bending radii min.	50 mm (fixed installation)
Additional tests	Tensile load test, transverse pressure test, reversed bending test, roller bending test, torsional stress test

FO E9/125

Number of cores x cross section	Part number	Outer diameter min. mm	Outer diameter max. mm	Net weight approx. kg/km
6 E9/125 Micron	20003606	9.7	10.1	100
6 x 2 E9/125 Micron	20003607	9.7	10.1	100
6 x 3 E9/125 Micron	20160113	9.7	10.1	100
6 x 4 E9/125 Micron	20024482	9.7	10.1	100

FO G50/125

Number of cores x cross section	Part number	Outer diameter min. mm	Outer diameter max. mm	Net weight approx. kg/km
6 G50/125 Micron	20003604	9.7	10.1	100
6 x 2 G50/125 Micron	20003605	9.7	10.1	100
6 x 3 G50/125 Micron	20008465	9.7	10.1	100
6 x 4 G50/125 Micron	20101418	9.7	10.1	100

FO G62.5/125

Number of cores x cross section	Part number	Outer diameter min. mm	Outer diameter max. mm	Net weight approx. kg/km
6 G62,5/125 Micron	20003601	9.7	10.1	100
6 x 2 G62,5/125 Micron	20003602	9.7	10.1	100
6 x 3 G62,5/125 Micron	20160111	9.7	10.1	100
6 x 4 G62,5/125 Micron	20160112	9.7	10.1	100

PROTOMONT (MSR) 2YSLGCGOEU 250V

Data, signal and control cables for mining installations



Application

Control, signalling and bus cables with the necessary transmission characteristics used for electric and electronic equipment, such as for measured value and process data processing and automation units in open-cast mining applications. Suitable for laying alongside conveyor belts and on material handling equipment.

Global data

Brand	PROTOMONT MSR-Mining
Type designation	2YSLGCGOEU
Standard	Based on DIN VDE 0250 part 812
Certifications / Approvals	Fire Certificate of Russian Federation

Design features

Conductor	Finely-stranded copper conductor (class 5)
Insulation	Basic material: Polyethylene (PE), Compound type: 2YI1
Core identification	Cores white with black digits imprinted
Core arrangement	Cores are laid-up in pairs in layers with a continuous serving of non-hygroscopic material over the conductor assembly
Inner sheath	Basic material (special compound type): Chlorinated rubber, Compound type: EM2
Screen	Screen braiding of tinned copper wires between inner and outer sheath
Outer sheath	Basic material (Special compound type): Chlorinated rubber, Compound type: EM2

Electrical parameters

Rated voltage	250/250 V
Maximum permissible operating voltage AC	0.350 (peak value) kV
Maximum permissible operating voltage DC	0.350 (peak value) kV
AC test voltage	1.5 kV

Chemical parameters

Resistance to fire	EN 60332-1-2, IEC 60332-1-2
Resistance to oil	EN 60811-404, IEC 60811-404
Weather resistance	Unrestricted use outdoors and indoors, resistant to ozone and moisture

Thermal parameters

Max. permissible temperature at conductor	60 °C
Max. short circuit temperature of the conductor	150 °C
Ambient temperature for fix installation min.	-40 °C
Ambient temperature for fix installation max.	60 °C
Ambient temp. in fully flex. operation min.	-25 °C
Ambient temp. in fully flex. operation max.	60 °C

Mechanical parameters

Tensile load on the conductor max .	15 N/mm ²
Torsional stress	25 °/m
Bending radii min.	Acc. to DIN VDE 0298 part 3

Number of cores x cross section	Part number	Conductor diameter max. mm	Outer diameter min. mm	Outer diameter max. mm	Net weight approx. kg/km	Permissible tensile force max. N	Conductor resistance at 20°C max. Ω/km	Nom. operating capacitance μF/km	Current carrying capacity (1) A
2 x 2 x 1	20005126	1.24	11	13	240	60	19.5	0.65	12
5 x 2 x 1	20005127	1.24	16.5	18.1	450	150	19.5	0.65	9
10 x 2 x 1	20005128	1.24	20.5	22.2	630	300	19.5	0.65	7
20 x 2 x 1	20005129	1.24	25.1	28.1	960	600	19.5	0.65	5

L-2YY(Z)Y KF 40 375V

strain resistant control cable according to DIN VDE 0817



Application

Strain resistant control and communication cables can be used as flexible control cable for the operation at conveyor belts in open cast mining applications. The cables are suitable for flexible applications in temperatures up to -40°C. L-2YY(Z)Y KF 40 is not approved for continuous laying in the ground.

Global data

Type designation	L-2YY(Z)Y KF 40
Standard	Based on DIN VDE 0817
Certifications / Approvals	Fire Certificate of the Russian Federation

Design features

Conductor	Finely stranded copper conductor (class 5)
Insulation	Thermoplastic compound (PE)
Core identification	First Quad Layer: 1. Strain: Red-Yellow, 2. Strain: Blue-Green Quad: 1. Strain: Natural Color-Yellow, 2. Strain: Blue-Green
Core arrangement	Four cores stranded as Star Quad (Twisted-Quad). These quads are subsequently stranded as cable core arrangement.
Inner sheath	Thermoplastic compound (PVC)
Reinforcement	Braiding of steel wires between inner and outer sheath
Outer sheath	Thermoplastic compound (PVC), Color: Grey, Cold resistant

Electrical parameters

Rated voltage	100/100V (<300/300V)
Maximum permissible operating voltage AC	0.375 kV
AC test voltage	1 kV
insulation resistance	5 MΩxkm
Conductor loop resistance at 20°C max.	77.8 Ω/km
max. operating capacitance	65 nF/km

Chemical parameters

Resistance to fire	EN 60332-1-2; IEC 60332-1-2
Weather resistance	Unrestricted use outdoors and indoors, resistant to ozone and moisture

Thermal parameters

Max. permissible temperature at conductor	60 °C
Ambient temperature for fix installation min.	-55 °C
Ambient temperature for fix installation max.	60 °C
Ambient temp. in fully flex. operation min.	-40 °C
Ambient temp. in fully flex. operation max.	50 °C

Number of cores x cross section	Part number	Outer diameter min. mm	Outer diameter max. mm	Net weight approx. kg/km	Permissible tensile force max. N
L-2YY(Z)Y KF 40 with 0,5 mm ²					
2x2x0,5 gr	20006820	7.3	9.3	112	30
5x2x0,5 gr	20006821	11.4	13	229	75
10x2x0,5 gr	20006822	15	17	383	150
20x2x0,5 gr	20006823	18.2	20.2	582	300

Underground Applications

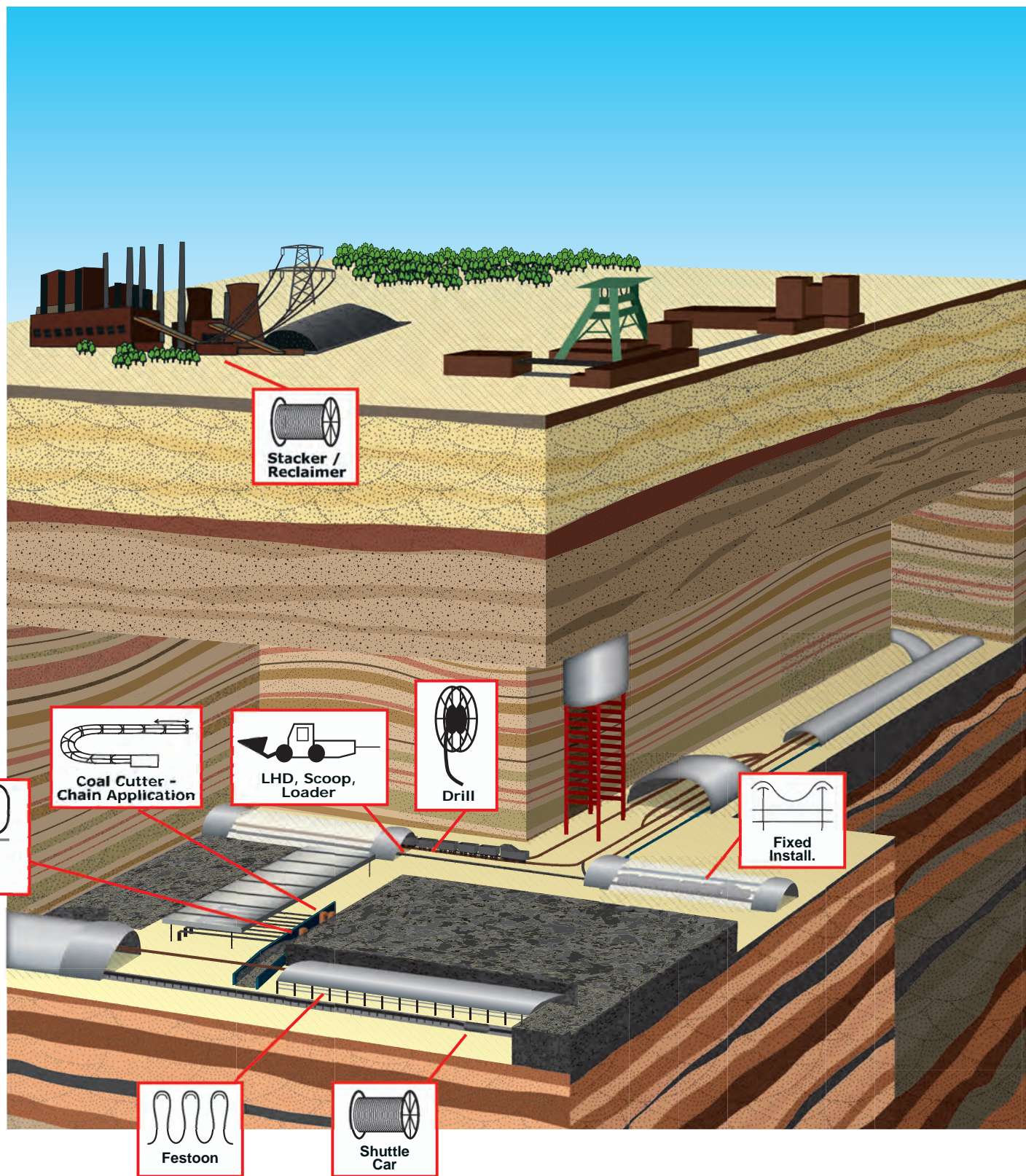

Application Groups

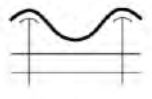
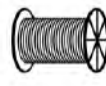
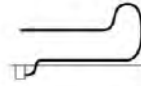
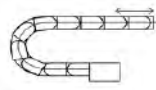

Shearer/C
hain

Shearer/T
railing

Reeling

Reeling

Festoon

semi-
fixed

Shearer/Chain

PROTOMONT(V)

+

-

-

-

+

+

PROTOMONT(VO)

+

-

-

-

+

+

TENAX CTE

+

-

-

-

+

+

Shearer/trailing

PROTOMONT(Z)

-

+

+

+

+

+

Underground Reeling

TENAX LK

-

-

+

+

+

+

PROTOMONT(S)

-

-

+

+

+

+

CORDAFLEX(S)

-

-

+

+

+

+

PROTOMONT(M+)

-

-

+

+

+

+

TBM Reeling

PROTOLON(TBM)

-

-

+

+

+

+

TENAX HTT

-

-

+

+

+

+

Semi fixed installation

PROTOMONT Festoon

-

-

-

-

+

+

SUPROMONT (N)3G...

-

-

-

-

+

+

PROTOMONT NSSH../3E

-

-

-

-

+

+

PROTOMONT(EMV FC)

-

-

-

-

+

+

BS 6708 Cables

Type 7-7M-7S

+

-

+

+

+

+

Type 307-307M-307S

+

-

+

+

+

+

Type 201-211-62-63-64

-

-

-

-

+

+

Type 321-331-631

-

-

-

-

+

+

Type 506-512-518-524

-

-

-

-

+

+

+

main application

+

suitable

-

not suitable

Underground Mining



SHEARER CABLES FOR CHAIN APPLICATION

	PROTOMONT(V)	PROTOMONT(V0)	TENAX CTE
Voltage range	0,6/1kV to 3,6/6kV	1,8/3kV (3,3kV)	0,6/1kV (1,2kV)
Permissible tensile force	max. 15N/mm ²	max. 15N/mm ²	max. 15N/mm ²
Cable design	Double screen technology; semicond. core screen (cold removable)	Single screen technology; semicond. core screen (cold removable)	Single screen technology; semicond. inner sheath
Stability against torsion	+/- 25°/m	+/- 50°/m	+/- 50°m
Sheath quality	5GM5	5GM3*	5GM5
Reversed bending stability	+++	+++	+++
Minimum bending radii	2,3xD (at max. 5N/mm ²) 5xD (at max. 15N/mm ²)	2,3xD (at max. 5N/mm ²) 5xD (at max. 15N/mm ²)	2,3xD (at max. 5N/mm ²) 5xD (at max. 15N/mm ²)
Fully flexible temperature range	-20°C to +60°C	-20°C to +60°C	-25°C to +60°C
Approvals	WUG Poland, MA China, Bosnia, TR-certificate, Fire certificate, Gost K, Gost B, MSHA P-189-4	MA China	TR-certificate, Fire certificate, Gost K, Gost B

* special compound for the Chinese version

PROTOMONT (V) 1kV

Coal cutter cables for chain operation

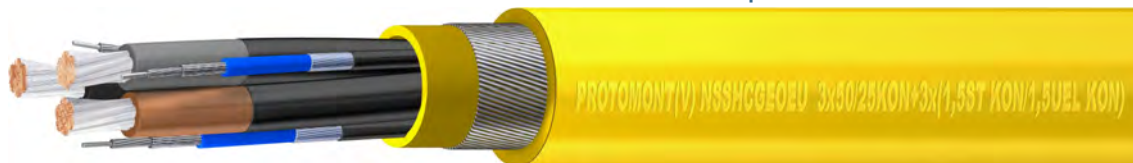

Application

Used as power supply connection cable for mobile equipment and machines in underground mining applications, such as coal cutting machines, etc. (V)-Coal-Cutter cables are designed for use in cable protection chains (cable handler), which are trailed behind the machine and which absorb the thereby occurring tensile forces.

Global data

Brand	PROTOMONT(V)
Type designation	NSSHKCGEOEU
Standard	DIN VDE 0250-812
Certifications / Approvals	MA - China MSHA P-07-KA140034-MSHA BAS - Bosnia-Herzegovina Fire Certificate of Russian Federation GOST K GOST B TR Certificate

Design features

Conductor	Finely stranded copper conductor, tinned (class FS)
PE-Conductor	Double concentric control/PE wire spinning in outer interstices
Insulation	PROTOLON, Basic material: EPR, Compound type: 3GI3
Electrical field control	Cold strippable outer layer of semiconductive rubber compound
Core identification	Main cores: Colored, Black, Grey, Brown; Control cores: Blue
Core arrangement	Three main cores laid-up, with double concentric control/PE conductor elements in the outer interstice, length of lay approx. 6xD
Description of spinning	Closed lay spinning of steel/copper wires in a vulcanized bond between inner and outer sheath
Inner sheath	Vulcanized rubber inner sheath, Basic material: EPR, Compound type: GM1B
Outer sheath	PROTOFIRM, Basic material: Synthetic elastomer compound e.g. CM, Compound type: 5GM5, Color: Yellow

Electrical parameters

Rated voltage	0.6/1 kV (600/1000V)
Maximum permissible operating voltage AC	0.7/1.2 kV
Maximum permissible operating voltage DC	0.9/1.8 kV
AC test voltage	3 kV
AC test voltage - Control Cores	2 kV

Chemical parameters

Resistance to fire	EN 60332-1-2, IEC 60332-1-2
Resistance to oil	Given according to EN 60811-404, IEC 60811-404
Weather resistance	Unrestricted use outdoors and indoors, resistant to ozone and moisture

Thermal parameters

Ambient temperature for fix installation min.	-40 °C
Ambient temperature for fix installation max.	80 °C
Ambient temp. in fully flex. operation min.	-20 °C
Ambient temp. in fully flex. operation max.	60 °C

Mechanical parameters

Tensile load on the conductor max .	15 N/mm ²
Bending radii min.	2.3 x D at a tensile load of max. 5 N/mm ²
Bending radii min.	Acc. to DIN VDE 0298 part 3
Minimum distance with S-type directional changes	20 x D

Number of cores x cross section	Conductor diameter max. mm	Outer diameter min. mm	Outer diameter max. mm	Net weight approx. kg/km	Permissible tensile force max. N	Conductor resistance at 20°C max. Ω/km	Nom. operating capacitance μF/km	Inductance nom. mH/km	Current carrying capacity (1) A	Short Circuit Current (conductor) kA
0.6/1 kV NSSHKCGE0EU, three-core design										
3x25+3x(1,5STKON+16/3KON)	7.1	38.4	41.4	2900	1125	0.795	0.36	0.33	131	3.58
3x35+3x(1,5STKON+16/3KON)	8.4	40	43	3300	1575	0.565	0.42	0.3	162	5.01
3x50+3x(1,5STKON+25/3KON)	10.1	45.4	48.4	4300	2250	0.393	0.45	0.28	202	7.15
3x70+3x(1,5STKON+35/3KON)	11.9	48.8	52.8	5400	3150	0.277	0.52	0.27	250	10.01
3x95+3x(1,5STKON+50/3KON)	14	56	60	7000	4275	0.21	0.55	0.27	301	13.59
3x120+3x(1,5STKON+70/3KON)	15.5	60.3	64.3	8600	5400	0.164	0.6	0.26	352	17.16
3x150+3x(1,5STKON+70/3KON)	17.2	66.7	70.7	10300	6750	0.132	0.61	0.26	404	21.45
3x185+3x(1,5STKON+95/3KON)	19.1	71.7	75.7	12300	8325	0.108	0.63	0.26	461	26.46
3x240+3x(1,5STKON+120/3KON)	22	80.1	85.1	15400	10800	0.0817	0.67	0.25	544	34.32

PROTOMONT (V) 3kV & 6kV

Coal cutter cables for chain operation



Application

Used as power supply connection cable for mobile equipment and machines in underground mining applications, such as coal cutting machines, etc. (V) Coal cutter cables are designed for use in cable protection chains (cable handler), which are trailed behind the machine and which absorb the thereby occurring tensile forces.

Global data

Brand	PROTOMONT(V)
Type designation	NTSKCGECW0EU
Standard	DIN VDE 0250-813
Certifications / Approvals	MA – China MSHA P-07-KA140034-MSHA WUG - Poland (6kV only) Fire Certificate of Russian Federation GOST K GOST B

Design features

Conductor	Finely stranded copper conductor, tinned (class FS)
PE-Conductor	Double concentric control/PE wire spinning in outer interstices
Insulation	PROTOLON, Basic material: EPR, Compound type: 3GI3
Electrical field control	Cold strippable outer layer of semiconductive rubber compound
Core identification	Main cores: Naturally colored, Control cores: Blue
Core arrangement	Three main cores laid-up, with double concentric control/PE conductor elements in the outer interstice, length of lay approx. 6xD
Inner sheath	Vulcanized rubber inner sheath, Basic material: EPR, Compound type: GM1B
Armouring	Closed-lay spinning of steel/copper wires in a vulcanized bond between inner and outer sheath
Outer sheath	PROTOFIRM, Basic material: synthetic elastomer compound e.g. CM, Compound type: 5GM5, Color: Red

Electrical parameters

Rated voltage	1.8/3 kV	3.6/6 kV
Maximum permissible operating voltage AC	2.1/3.6 kV	4.2/7.2 kV
Maximum permissible operating voltage DC	2.7/5.4 kV	5.4/10.8 kV
AC test voltage	6 kV	11 kV
AC test voltage - Control Cores	2 kV	2 kV

Chemical parameters

Resistance to fire	EN 60322-1-2, IEC 60322-1-2
Resistance to oil	Given in accordance with EN 60811-404, IEC 60811-404
Weather resistance	Unrestricted use outdoors and indoors, resistant to ozone and moisture

Thermal parameters

Max. permissible temperature at conductor	90 °C
Max. short circuit temperature of the conductor	250 °C
Ambient temperature for fix installation min.	-40 °C
Ambient temperature for fix installation max.	80 °C
Ambient temp. in fully flex. operation min.	-20 °C
Ambient temp. in fully flex. operation max.	60 °C

Mechanical parameters

Tensile load on the conductor max .	15 N/mm ²
Bending radii min.	2.3 x D at a tensile load of max. 5 N/mm ²
Bending radii min.	Acc. to DIN VDE 0298 part 3
Minimum distance with S-type directional changes	20 x D

Rated voltage 1.8/3 kV

Number of cores x cross section	Part number	Conductor diameter max. mm	Outer diameter min. mm	Outer diameter max. mm	Net weight approx. kg/km	Permissible tensile force max. N	Conductor resistance at 20°C max. Ω/km	Nom. operating capacitance μF/km	Inductance nom. mH/km	Current carrying capacity (1) A	Short Circuit Current (conductor) kA
1.8/3 kV NTSKCGECW0EU. three-core design											
3x25+3x(1,5STKON+16/3KON)		7.1	40.1	43.1	3100	1125	0.795	0.28	0.32	131	3.58
3x35+3x(1,5STKON+16/3KON)	20016353	8.4	44.3	47.3	3800	1575	0.565	0.31	0.3	162	5.01
3x50+3x(1,5STKON+25/3KON)	20024209	10.1	48	51	4600	2250	0.393	0.36	0.29	202	7.15
3x70+3x(1,5STKON+35/3KON)	20005071	11.9	53.2	57.2	5900	3150	0.277	0.42	0.27	250	10.01
3x95+3x(1,5STKON+50/3KON)	20005051	14	58.6	62.6	7400	4275	0.21	0.45	0.27	301	13.59
3x120+3x(1,5STKON+70/3KON)	20005072	15.5	62.9	66.9	9000	5400	0.164	0.49	0.27	352	17.16
3x150+3x(1,5STKON+70/3KON)	20007583	17.2	68.4	72.4	10600	6750	0.132	0.54	0.26	404	21.45
3x185+3x(1,5STKON+95/3KON)	20007584	19.1	72.5	76.5	12400	8325	0.108	0.59	0.25	461	26.46
3x240+3x(1,5STKON+120/3KON)	20008325	22	80.1	85.1	15400	10800	0.0817	0.67	0.25	544	34.32

Rated voltage 3.6/6 kV

Number of cores x cross section	Part number	Conductor diameter max. mm	Outer diameter min. mm	Outer diameter max. mm	Net weight approx. kg/km	Permissible tensile force max. N	Conductor resistance at 20°C max. Ω/km	Nom. operating capacitance μF/km	Inductance nom. mH/km	Current carrying capacity (1) A	Short Circuit Current (conductor) kA
3.6/6 kV NTSKCGECW0EU. three-core design											
3x25+3x(1,5STKON+16/3KON)		7.1	45	48	3600	1125	0.795	0.21	0.35	131	3.58
3x35+3x(1,5STKON+16/3KON)	20005070	8.4	47.8	50.8	4200	1575	0.565	0.23	0.33	162	5.01
3x50+3x(1,5STKON+25/3KON)	20048331	10.1	51	55	5100	2250	0.393	0.27	0.32	202	7.15
3x70+3x(1,5STKON+35/3KON)	20005068	11.9	56.7	60.7	6400	3150	0.277	0.3	0.3	250	10.01
3x95+3x(1,5STKON+50/3KON)	20005069	14	61.2	65.2	7800	4275	0.21	0.34	0.29	301	13.59
3x120+3x(1,5STKON+70/3KON)	20008860	15.5	67.3	71.3	9700	5400	0.164	0.37	0.28	352	17.16
3x150+3x(1,5STKON+70/3KON)	20042611	17.2	71	75	11000	6750	0.132	0.41	0.28	404	21.45
3x185+3x(1,5STKON+95/3KON)	20005079	19.1	75.1	79.1	12900	8325	0.108	0.45	0.27	461	26.46
3x240+3x(1,5STKON+120/3KON)		22	82.7	87.7	15900	10800	0.0817	0.5	0.26	544	34.32

PROTOMONT (VO)

Coal cutter cables for chain operation



Application

Used as power supply connection cable for mobile equipment and machines in underground mining applications, such as coal cutting machines, etc. (VO)-Coal-Cutter cables are designed for use in cable protection chains(cable handler), which are trailed behind the machine and which absorb the thereby occurring tensile forces.

Global data

Brand	PROTOMONT(VO)
Type designation	NTSKCGEWOEU
Standard	DIN VDE 0250-813
Certifications / Approvals	MA – China

Design features

Conductor	Finely-stranded copper conductor, tinned (class FS)
PE-Conductor	3 Double-concentric control / PE conductor elements in the outer interstices
Insulation	PROTOLON, Basic material: EPR, Compound type: 3GI3
Electrical field control	Cold strippable outer layer of semiconductive rubber compound
Core identification	Main cores: Natural color Control cores: Blue
Core arrangement	Three main cores laid-up, with double concentric control / PE conductor elements in the outer interstices, length of lay approx. 6 x D
Inner sheath	Vulcanized rubber inner sheath, Basic material: EPR, Compound type: better GM1B
Outer sheath	PROTOFIRM, Basic material: synthetic elastomer compound e.g. CM, Compound type: 5GM5, Color: Red

Electrical parameters

Rated voltage	1.8/3 kV
Maximum permissible operating voltage AC	2.1/3.6 kV
Maximum permissible operating voltage DC	2.7/5.4 kV
AC test voltage	6 kV
AC test voltage - Control Cores	2 kV

Chemical parameters

Resistance to fire	EN 60322-1-2, IEC 60322-1-2
Resistance to oil	EN 60811-404, IEC 60811-404
Weather resistance	Unrestricted use outdoors and indoors, resistant to ozone and moisture

Thermal parameters

Max. permissible temperature at conductor	90 °C
Max. short circuit temperature of the conductor	250 °C
Ambient temperature for fix installation min.	-40 °C
Ambient temperature for fix installation max.	80 °C
Ambient temp. in fully flex. operation min.	-20 °C
Ambient temp. in fully flex. operation max.	60 °C

Mechanical parameters

Tensile load on the conductor max .	15 N/mm ²
Bending radii min.	Acc. to DIN VDE 0298 part 3
Bending radii min.	2.3 x D at a tensile load of max. 5 N/mm ²
Minimum distance with S-type directional changes	20 x D

Number of cores x cross section	Part number	Conductor diameter max. mm	Outer diameter min. mm	Outer diameter max. mm	Net weight approx. kg/km	Permissible tensile force max. N	Conductor resistance at 20°C max. Ω/km	Nom. operating capacitance μF/km	Inductance nom. mH/km	Current carrying capacity (1) A	Short Circuit Current (conductor) kA
1.8/3 kV (N)TSKCGEWOEU, three-core design											
3x25+3x(1,5STKON+16/3KON)		7.1	37.8	40.8	2500	1125	0.795	0.28	0.34	131	3.58
3x35+3x(1,5STKON+16/3KON)		8.4	42	45	3150	1575	0.565	0.31	0.33	162	5.01
3x50+3x(1,5STKON+25/3KON)		10.1	45.7	48.7	3950	2250	0.393	0.36	0.31	202	7.15
3x70+3x(1,5STKON+35/3KON)		11.9	50.9	54.9	5000	3150	0.277	0.42	0.3	250	10.01
3x95+3x(1,5STKON+50/3KON)	20069403	14	56.3	60.3	6350	4275	0.21	0.45	0.29	301	13.59
3x120+3x(1,5STKON+70/3KON)	20069404	15.5	60.1	64.1	7800	5400	0.164	0.49	0.28	352	17.16
3x150+3x(1,5STKON+70/3KON)	20026143	17.2	65.6	69.6	9000	6750	0.132	0.54	0.28	404	21.45
3x185+3x(1,5STKON+95/3KON)	20070763	19.1	69.7	73.7	10500	8325	0.108	0.59	0.27	461	26.46
3x240+3x(1,5STKON+120/3KON)		22	77.8	81.8	13500	10800	0.0817	0.67	0.26	544	34.32
3x300+3x(1,5STKON+150/3KON)		24.8	83.4	88.4	17110	13500	0.0654	0.74	0.25	626	42.9

TENAX CTE

Coal cutter cables for chain operation

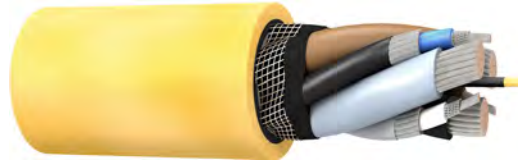

Application

For the connection of mobile machines under very high mechanical loads, predominantly for underground mining applications, e.g. for coal-cutting machines, particularly suitable for extreme bending loads under low tensile stress, if the cable is protected against high tensile forces by the cable chain.

Global data

Brand	TENAX-CTE
Type designation	NSSHKCGEOEU
Standard	Based on DIN VDE 0250 part 812
Certifications / Approvals	Fire Certificate of Russian Federation TR-Certificate GOST K GOST B

Design features

Conductor	Finely stranded conductor of tinned copper wires (0,3mm) in special flexible design
PE-Conductor	Distributed as a spinning of tinned copper wires and a conductive tape
Insulation	rubber compound EPR-3GI3, colored
Core identification	Main cores: Black, Grey, Brown Control cores: Blue
Core arrangement	Cores cabled around semi-conductive cradle
Inner sheath	Made of semi-conductive rubber
Pilot conductor	Pilot cores with copper/steel conductors capable of expansion and compression, EPR-insulation
Armouring	Polyester anti-torsion braid
Outer sheath	Rubber compound type: 5GM5, acc. to DIN VDE 0207 part 21, Color: Yellow

Electrical parameters

Rated voltage	0.6/1 kV (600/1000V)
Maximum permissible operating voltage AC	0.7/1.2 kV
Maximum permissible operating voltage DC	0.9/1.8 kV
AC test voltage	3 kV

Chemical parameters

Resistance to fire	EN 60322-1-2, IEC 60322-1-2
Resistance to oil	EN 60811-404, IEC 60811-404
Weather resistance	Unrestricted use outdoors and indoors, resistant to ozone and moisture

Thermal parameters

Max. permissible temperature at conductor	90 °C
Max. short circuit temperature of the conductor	250 °C
Ambient temperature for fix installation min.	-40 °C
Ambient temperature for fix installation max.	80 °C
Ambient temp. in fully flex. operation min.	-25 °C
Ambient temp. in fully flex. operation max.	60 °C

Mechanical parameters

Bending radii min.	5 x D at a tensile load of max. 15 N/mm ²
Bending radii min.	2.3 x D at a tensile load of max. 5 N/mm ²

Number of cores x cross section	Part number	Conductor diameter max. mm	Outer diameter min. mm	Outer diameter max. mm	Net weight approx. kg/km	Permissible tensile force max. N	Conductor resistance at 20°C max. Ω/km	Nom. operating capacitance μF/km	Inductance nom. mH/km	Current carrying capacity (1) A	Short Circuit Current (conductor) kA
3x25+3x(1,5ST+16/3)		7	36	40	2790	1125	0.795	0.52	0.29	131	3.05
3x35+3x(1,5ST+16/3)	20076049	8.2	38	42	3390	1575	0.565	0.59	0.28	162	4.27
3x50+3x(1,5ST+25/3)	20076047	10.2	46	51	3600	2250	0.393	0.62	0.27	202	6.1
3x70+3x(1,5ST+35/3)	20099802	12.2	47	52	4150	3150	0.277	0.72	0.26	250	8.5
3x95+3x(1,5ST+50/3)	20099803	13.2	53	57	5200	4275	0.21	0.69	0.26	301	11.6
3x120+3x(1,5ST+70/3)		15.2	58	63	8300	5400	0.164	0.86	0.25	352	14.6
3x150+3x(1,5ST+70/3)		17.1	62	68	9300	6750	0.132	0.78	0.25	404	18.3

Underground Mining



SHEARER CABLES FOR FREE TRAILING

PROTOMONT (Z) NSSHKCGEOEU

Coal cutter cables for trailing operations



Application

Used as power supply connection cable for mobile equipment in underground machine applications, such as coal shearer, roadheader, TBM's or scoops (LHDs). (Z)-Coal-Cutter cables are designed for free trailing operation and due to their special construction may be trailed for considerable distances behind the machine during operation.

Global data

Brand	PROTOMONT(Z)
Type designation	NSSHKCGEOEU
Standard	DIN VDE 0250-812
Certifications / Approvals	MSHA P-189-4 BAS Bosnia-Herzegovina Fire Certificate of Russian Federation TR-Certificate GOST K GOST B

Design features

Conductor	Very finely stranded copper conductor, tinned (class FS)
PE-Conductor	3 Double-concentric control/PE wire spinning in the outer interstice
Insulation	PROTOLON, Basic material: EPR, Compound type: 3GI3
Core identification	Main cores: Colored, Black, Grey, Brown; Control cores: Blue
Core arrangement	Three main conductors laid-up, with double-concentric control/PE conductor elements in the outer interstice, length of lay approx. 6 x D
Inner sheath	Vulcanized rubber inner sheath, Basic material: EPR, Compound type: GM1B
Armouring	Braid of steel/copper wires in a vulcanized bond between inner and outer sheath
Outer sheath	PROTOFIRM, Basis:synthetic elastomer compound e.g. CM, Compound type: 5GM5, Color: Yellow

Electrical parameters

Rated voltage	0.6/1 kV (600/1000V)
Maximum permissible operating voltage AC	0.7/1.2 kV
Maximum permissible operating voltage DC	0.9/1.8 kV
AC test voltage	3 kV
AC test voltage - Control Cores	2 kV

Chemical parameters

Resistance to fire	EN 60332-1-2, IEC 60332-1-2
Resistance to oil	EN 60811-404, IEC 60811-404
Weather resistance	Unrestricted use outdoors and indoors, resistant to ozone and moisture

Thermal parameters

Max. permissible temperature at conductor	90 °C
Max. short circuit temperature of the conductor	250 °C
Ambient temperature for fix installation min.	-40 °C
Ambient temperature for fix installation max.	80 °C
Ambient temp. in fully flex. operation min.	-20 °C
Ambient temp. in fully flex. operation max.	60 °C

Mechanical parameters

Max. tensile load of cable	40 N/mm ²
Minimum Breaking load of steel braid	45 kN
Torsional stress	25 °/m
Travel speed	150 m/min

Number of cores x cross section	Conductor diameter max. mm	Outer diameter min. mm	Outer diameter max. mm	Net weight approx. kg/km	Permissible tensile force max. N	Breaking load of the braid kN	Conductor resistance at 20°C max. Ω/km	Nom. operating capacitance μF/km	Inductance nom. mH/km	Current carrying capacity (1) A	Short Circuit Current (conductor) kA
3x25+3x(1,5STKON+16/3KON)	7.1	39.2	42.2	2700	3000	45	0.795	0.37	0.33	131	3.58
3x35+3x(1,5STKON+16/3KON)	8.4	40.8	43.8	3100	4200	45	0.565	0.42	0.3	162	5.01
3x50+3x(1,5STKON+25/3KON)	10.1	46.2	49.2	4000	6000	45	0.393	0.45	0.28	202	7.15
3x70+3x(1,5STKON+35/3KON)	11.9	49.6	53.6	5100	8400	45	0.277	0.52	0.27	250	10.01
3x95+3x(1,5STKON+50/3KON)	14	56.8	60.8	6700	11400	45	0.21	0.55	0.27	301	13.59
3x120+3x(1,5STKON+70/3KON)	15.5	60.6	64.6	8000	14400	45	0.164	0.59	0.26	352	17.16
3x150+3x(1,5STKON+70/3KON)	17.6	67	71	9600	18000	45	0.132	0.61	0.26	404	18.3
3x185+3x(1,5STKON+95/3KON)	19.1	72	76	11500	22200	45	0.108	0.63	0.26	461	26.46
3x240+3x(1,5STKON+120/3KON)	22	80.4	85.4	14600	28800	45	0.0817	0.67	0.25	544	34.32
3x300+3x(1,5STKON+150/3KON)	24.8	89.1	94.1	18700	36000	45	0.0654	0.7	0.25	626	42.9

Underground Mining



UNDERGROUND REELING CABLES

	TENAX LK	PROTOMONT(S)	CORDAFLEX(S)	PROTOMONT(M+)
Travel speed	max. 160m/min	max. 160m/min	max. 160m/min	max. 60m/min
Permissible tensile force	30N/mm ²	30N/mm ²	30N/mm ²	15N/mm ²
Special cable design features	Steel + copper pilot/earth core element; semiconductive inner sheath	Double concentric copper pilot/earth core element; semiconductive core screen	No semi-conductive layer	No semi-conductive layer
Stability against torsion	+/- 100°/m	+/- 50°/m	+/- 25°m	+/- 25°m
Sheath quality	5GM5	5GM5*	5GM5	5GM5
Sheath abrasion	+++	+++	+++	++
Reversed bending stability	+++	+++	+++	++
S-bendings in operation	Multiple planes	Multiple planes	Multiple planes	Single plane
Fully flexible temperature range	-25°C to +60°C	-25°C to +60°C	-25°C to +60°C	-25°C to +60°C
Approvals	TR-certificate, Fire certificate, Gost K, Gost B	MA China, TR-certificate, Fire certificate, Gost K, Gost B,	MSHA, TR-certificate, Fire certificate, Gost K, Gost B	-

* special outer sheath compound for the Chinese version

TENAX-LK

Loader cable with special pilot cores, twist protection and central strain relief element



Application

These cables are intended for mining applications under very high mechanical loads, e.g. fast moving machines like shuttle cars etc. where frequent winding and unwinding is required during operation, in particular with simultaneous tensile strain and/or torsion stress and/or forced guidance of the cable.

Global data

Type designation	NTSKCGEWOEU
Standard	DIN VDE 0250-813
Certifications / Approvals	Fire Certificate of Russian Federation TR-Certificate GOST K GOST B

Design features

Conductor	Tinned copper, extra finely stranded (class 5), according to DIN VDE 0295
Insulation	Rubber compound type 3GI3 acc. to DIN VDE 0207 part 20 Separator: Polyester tape
Special Pilot / PE element	Copper and steel conductor capable of expansion and compression covert with EPR insulation. Earth core as a spinning of tinned copper bunches covered with semi-conductive tape.
Core identification	Core colors: Brown, Black, Grey Control core: Blue
Core arrangement	Cores laid up around conductive central cradle separator with aramid rope
Inner sheath	Semi conductive inner sheath
Reinforcement	Extremely tear-resistant reinforcing tape, which prevents sheath movement.
Outer sheath	Outer sheath of black chlorinated rubber compound 5GM5, abrasion and tear-resistant, oil-resistant and flame retardant

Electrical parameters

Rated voltage	0.6/1 kV (600/1000V)
Maximum permissible operating voltage AC	0.7/1.2 kV
Maximum permissible operating voltage DC	0.9/1.8 kV
AC test voltage	4 kV

Chemical parameters

Resistance to fire	EN 60332-1-2, IEC 60332-1-2
Resistance to oil	EN 60811-404, IEC 60811-404
Weather resistance	Unrestricted use outdoors and indoors, resistant to ozone, UV and moisture

Thermal parameters

Max. permissible temperature at conductor	90 °C
Ambient temperature for fix installation min.	-40 °C
Ambient temperature for fix installation max.	80 °C
Ambient temp. in fully flex. operation min.	-25 °C
Ambient temp. in fully flex. operation max.	60 °C

Mechanical parameters

Max. tensile load of cable	30 N/mm ²
Torsional stress	100 °/m
Bending radii min.	Acc. to DIN VDE 0298 part 3
Travel speed	max. 160 m/min

Number of cores x cross section	Part number	Conductor diameter max. mm	Outer diameter min. mm	Outer diameter max. mm	Net weight approx. kg/km	Permissible tensile force max. N	Conductor resistance at 20°C max. Ω/km	Nom. operating capacitance μF/km	Inductance nom. mH/km	Current carrying capacity (1) A	Short Circuit Current (conductor) kA
3x16 + 3x(1,5ST +16/3)	20074226	5	30.1	32.6	1525	720	1.24	1.5	0.23	99	1.9
3x25 + 3x(1,5ST +16/3)		6.2	37	39.5	2150	1125	0.8	1.56	0.22	131	3
3x35 + 3x(1,5ST +25/3)		7.5	39.8	42.3	2575	1575	0.565	1.67	0.22	162	4.27
3x50 + 3x(1,5ST +25/3)		9	42.9	45.4	3150	2250	0.393	1.79	0.22	202	6.1
3x70 + 3x(1,5ST +35/3)		10.6	46.4	48.9	4000	3150	0.277	1.92	0.22	250	9
3x95 + 3x(1,5ST +50/3)		12.6	53.2	56.7	5525	4275	0.21	1.84	0.22	301	13
3x16 + 2x10 + 1x1,5ST	20135821	5	32	36	1900	720	1.24	1.36	0.23	99	1.9
3 x 25+2x10+1x1,5ST		6.2	36	40	2350	1125	0.8	1.52	0.22	131	3

PROTOMONT (S) Reeling cable



Application

For frequently changing dynamic loads, such as reeling cables for scoops (LHDs) in underground mines, suitable for mono-spiral reels and cylindrical reels. High tensile strength through suspension strand and very high abrasion and tear resistance of the outer sheath.

Global data

Brand	PROTOMONT(S)
Type designation	(N)SSHCGE0EU
Standard	DIN VDE 0250-812
Certifications / Approvals	MA - China Fire Certificate of Russian Federation TR-Certificate GOST K GOST B

Design features

Conductor	Electrolytic copper, tinned, very finely stranded (class FS)
PE-Conductor	3 double concentric control/earth wire spinning in outer interstices
Insulation	Basic material: EPR, Compound type: 3GI3
Core identification	Black, Brown, Grey
Core arrangement	Three main cores stranded with three control/earth cores in outer interstices, length of lay approx. 6 x D
Description of spinning	Reinforced braid of polyester threads in a vulcanized bond between inner and outer sheath, Surface covered: approx. 25%
Inner sheath	Basic material: EPR, Compound type: GM1B
Outer sheath	Basic material: Synthetic elastomer compound e.g. CR, Compound type: 5GM5, Color: Yellow

Electrical parameters

Rated voltage	U ₀ /U = 0,6/1 kV, also permitted for U ₀ /U = 640/1140V
Maximum permissible operating voltage AC	0.7/1.2 kV
Maximum permissible operating voltage DC	0.9/1.8 kV
AC test voltage	2.5 kV

Chemical parameters

Resistance to fire	EN 60332-1-2, IEC 60332-1-2
Resistance to oil	EN 60811-404, IEC 60811-404
Weather resistance	Unrestricted use outdoors and indoors, resistant to ozone, UV and moisture

Thermal parameters

Max. permissible temperature at conductor	90 °C
Ambient temperature for fix installation min.	-40 °C
Ambient temperature for fix installation max.	80 °C
Ambient temp. in fully flex. operation min.	-25 °C
Ambient temp. in fully flex. operation max.	60 °C

Mechanical parameters

Tensile load on the conductor max .	30 N/mm ²
Torsional stress	50 °/m
Bending radii min.	4 x D
Minimum distance with S-type directional changes	20 x D
Travel speed	Max. 160 m/min
Additional tests	Reversed bending test, roller bending test

Number of cores x cross section	Part number	Conductor diameter max. mm	Outer diameter min. mm	Outer diameter max. mm	Net weight approx. kg/km	Permissible tensile force max. N	Conductor resistance at 20°C max. Ω/km	Nom. operating capacitance μF/km	Inductance nom. mH/km	Current carrying capacity (1) A	Short Circuit Current (conductor) kA
3x16+3x(1,5STKON+10/3KON)	20025111	5.8	31.1	34.4	1748	1440	1.24	0.5	0.3	99	1.95
3x25+3x(1,5STKON+16/3KON)	20025108	7.3	36.9	39.9	2409	2250	0.795	0.52	0.29	131	3.05
3x35+3x(1,5STKON+16/3KON)	20024964	8.4	41.2	44.2	2676	3150	0.565	0.6	0.28	162	4.27
3x50+3x(1,5STKON+25/3KON)		10.3	44.5	47.5	3800	4500	0.393	0.61	0.27	202	6.1
3x70+3x(1,5STKON+35/3KON)		12	47.3	50.3	4500	6300	0.277	0.7	0.26	250	8.54
3x95+3x(1,5STKON+50/3KON)		14	54.8	58.8	5300	8550	0.21	0.72	0.26	301	11.59
3x120+3x(1,5STKON+70/3KON)		15.8	58.7	62.7	6100	10800	0.164	0.79	0.25	352	14.64

CORDAFLEX (S) NSHTOEU

LHD cables for scoop operations



Application

For frequently changing dynamic loads, such as reeling cables for scoops (LHDs) in underground mines, suitable for mono-spiral reels and cylindrical reels.

Global data

Brand	CORDAFLEX(S)
Type designation	NSHTOEU
Standard	DIN VDE 0250-814
Certifications / Approvals	MSHA P-189-3 Fire Certificate of Russian Federation TR-Certificate GOST K GOST B

Design features

Conductor	Electrolytic copper, tinned, very finely stranded (class FS)
PE-Conductor	Green-yellow core
Insulation	Basic material: EPR, Compound type: 3GI3
Core identification	Black, Grey, Brown, Green-Yellow
Core arrangement	Cores laid-up, length of lay 5 x D
Support element	Centrally arranged Kevlar central support element
Inner sheath	Compound type: 5GM5, Color: Yellow
Reinforcement	Reinforced braid of polyester threads in a vulcanized bond between inner and outer sheath, Surface covered: approx. 25%
Outer sheath	Basic material: synthetic elastomer compound e.g. CR, Compound type: 5GM5, Color: Yellow

Electrical parameters

Rated voltage	U ₀ /U = 0,6/1 kV, also permitted for U ₀ /U = 640/1140V
Maximum permissible operating voltage AC	0.7/1.2 kV
Maximum permissible operating voltage DC	0.9/1.8 kV
AC test voltage	2.5 kV

Chemical parameters

Resistance to fire	EN 60332-1-2, IEC 60332-1-2
Resistance to oil	EN 60811-404, IEC 60811-404
Weather resistance	Unrestricted use outdoors and indoors, resistant to ozone, UV and moisture

Thermal parameters

Max. permissible temperature at conductor	90 °C
Max. short circuit temperature of the conductor	250 °C
Ambient temperature for fix installation min.	-40 °C
Ambient temperature for fix installation max.	80 °C
Ambient temp. in fully flex. operation min.	-25 °C
Ambient temp. in fully flex. operation max.	60 °C

Mechanical parameters

Tensile load on the conductor max .	30 N/mm ²
Torsional stress	25 °/m
Bending radii min.	Acc. to DIN VDE 0298 part 3
Minimum distance with S-type directional changes	20 x Cable Diameter
Travel speed	max. 160 m/min
Additional tests	Reversed bending test, roller bending test

Number of cores x cross section	Part number	Conductor diameter max. mm	Outer diameter min. mm	Outer diameter max. mm	Net weight approx. kg/km	Permissible tensile force max. N	Conductor resistance at 20°C max. Ω/km	Nom. operating capacitance μF/km	Inductance nom. mH/km	Current carrying capacity (1) A	Short Circuit Current (conductor) kA
4 x 16 (6 kN)		5.8	28	31	1450	1920	1.24	0.5	0.3	99	2.29
4 x 25 (6 kN)	20041914	7.3	34	37	2170	3000	0.795	0.54	0.29	131	3.58
4 x 35 (12 kN)	20151818	8.4	38	41	2930	4200	0.565	0.6	0.28	162	5.01
4 x 50 (12 kN)		10.3	44.8	47.8	4000	6000	0.393	0.62	0.27	202	7.15
4 x 50 (30 kN)	20004210	10.3	42	44	3560	6000	0.393	0.62	0.27	202	7.15
4 x 70 (20 kN)	20004222	12	48.3	51.3	4910	8400	0.277	0.71	0.26	250	10.01
4 x 95 (30 kN)	20004219	14	51	53	5870	11400	0.21	0.72	0.26	301	13.59

PROTOMONT (M+) (N)SHOEU-J

Reeling cables for drills etc.



Application

PROTOMONT(M+) reeling cables are used as power supply cables for the use with underground mining equipment. The cables are designed for frequently changing dynamic loads, such as reeling cables for drills and LHD's. The cables withstand high mechanical stress caused by reeling application and the abrasion to be expected in trailing operations. PROTOMONT(M+) is suitable for use with mono-spiral reels and cylindrical reels.

Global data

Brand	PROTOMONT(M+)
Type designation	(N)SHOEU-J
Standard	Based on DIN VDE 0250 part 812

Design features

Conductor	Electrolytic copper, not tinned, finely stranded (class 5)
Insulation	PROTOLON, Basic material: EPR, Compound type: 3GI3
Core identification	Natural colouring with black digits printed consecutively
Core arrangement	Three main conductors laid-up together with the protective-earth conductor, from 50 mm ² with protective-earth conductor split into three in the outer interstices
Inner sheath	Basic material: EPR, Special compound
Outer sheath	Basic material: Chlorinated rubber, Compound type: 5GM5, Color: Yellow

Electrical parameters

Rated voltage	0.6/1 kV (600/1000V)
Maximum permissible operating voltage AC	0.7/1.2 kV
Maximum permissible operating voltage DC	0.9/1.8 kV
AC test voltage	3 kV

Chemical parameters

Resistance to fire	EN 60332-1-2, IEC 60332-1-2
Resistance to oil	EN 60811-404, IEC 60811-404
Weather resistance	Unrestricted use outdoors and indoors, resistant to ozone, UV and moisture

Thermal parameters

Max. permissible temperature at conductor	90 °C
Max. short circuit temperature of the conductor	250 °C
Ambient temperature for fix installation min.	-40 °C
Ambient temperature for fix installation max.	80 °C
Ambient temp. in fully flex. operation min.	-25 °C
Ambient temp. in fully flex. operation max.	60 °C

Mechanical parameters

Tensile load on the conductor max .	15 N/mm ²
Torsional stress	25 °/m
Bending radii min.	Acc. to DIN VDE 0298 part 3
Travel speed	max. 60 m/min

Number of cores x cross section	Part number	Conductor diameter max. mm	Outer diameter min. mm	Outer diameter max. mm	Net weight approx. kg/km	Permissible tensile force max. N	Conductor resistance at 20°C max. Ω/km	Nom. operating capacitance μF/km	Inductance nom. mH/km	Current carrying capacity (1) A	Short Circuit Current (conductor) kA
3x50+3x25/3		9.4	30.3	33.3	2320	2250	0.386	0.54	0.25	202	6.1
3x70+3x35/3	20016040	11.1	36.2	39.2	3348	3150	0.272	0.61	0.24	250	8.54
3x95+3x50/3	20015116	12.9	40.9	43.9	4315	4275	0.206	0.64	0.24	301	11.59
3x120+3x70/3	20008590	14.6	45	48	5483	5400	0.161	0.72	0.23	352	14.64
3x150+3x70/3		16.5	50.8	54.8	6930	6750	0.129	0.72	0.23	404	18.3
3x185+3x95/3		17.9	54.6	58.6	8100	8325	0.106	0.71	0.23	461	22.57
3x240+3x120/3	20008475	20.7	62.2	66.2	10430	10800	0.08	0.76	0.23	540	26.56
3x300+3x150/3		23.5	68.7	72.7	12900	13500	0.064	0.78	0.23	633	29.28

Underground Mining



CABLES FOR TBM-REELING

	PROTOMONT TBM	TENAX HTT
Application	Reeling	Reeling
Travel speed	max. 30m/min	max. 30m/min
Permissible tensile force	15N/mm ²	15N/mm ²
Cable design	based on VDE, double screen technology	acc. to VDE, single screen technology
Stability against torsion	+/- 25°/m	+/- 100°/m
Sheath quality	5GM5	5GM5*
Sheath abrasion against surface	+++	+++
Reversed bending stability	+++	+++
Temperature range in fully flexible operation	-20°C to +60°C	-20°C to +60°C
Cold removable semicon screens	+++	+++
Approvals	Fire certificate, Gost K, Gost B	Fire certificate, Gost K, Gost B

PROTOMONT TBM

Medium voltage reeling cable for use with TBMs



Application

The cables are suitable for use as reeling power supply cables for tunnel boring machines (TBM) in underground mines and for tunnel construction sites.

Global data

Brand	PROTOMONT TBM
Type designation	(N)TSCGECW0EU
Standard	Based on DIN VDE 0250-813
Certifications / Approvals	Fire Certificate of Russian Federation GOST K GOST B

Design features

Conductor	Finely stranded copper conductor, tinned (class 5)
Control Core	In outer interstice
PE-Conductor	Single concentric copper/textile mixed braid over every core
Insulation	PROTOLON, Basic material: EPR, Compound type: special compound
Electrical field control	Inner and outer protective layer of semiconductive rubber compound
Core identification	Main cores: Natural coloring with black semiconductive rubber, Control cores: Black
Core arrangement	Three main conductors laid-up with three control cores in the outer interstice
Inner sheath	Vulcanized rubber inner sheath, Basic material: EPR, Compound type: GM1B
Monitoring conductor	Overall concentric lay of copper wire spinning
Outer sheath	PROTOFIRM, synthetic elastomer compound e.g. CR, Compound type: 5GM5, Color: Red

Electrical parameters

Rated voltage	3.6/6 kV	6/10 kV	8.7/15 kV	12/20 kV	14/25 kV	18/30 kV
Maximum permissible operating voltage AC	4.2/7.2 kV	6.9/12 kV	10.4/18 kV	13.9/24 kV	17.3/30 kV	20.8/36 kV
Maximum permissible operating voltage DC	5.4/10.8 kV	9/18 kV	13.5/27 kV	18/36 kV	22.5/45 kV	27/54 kV
AC test voltage	11 kV	17 kV	24 kV	29 kV	36 kV	43 kV

Chemical parameters

Resistance to fire	EN 60332-1-2, IEC 60332-1-2
Resistance to oil	Given according to EN 60811-404, IEC 60811-404
Weather resistance	Unrestricted use outdoors and indoors, resistant to ozone and moisture

Thermal parameters

Max. permissible temperature at conductor	90 °C
Max. short circuit temperature of the conductor	250 °C
Ambient temperature for fix installation min.	-40 °C
Ambient temperature for fix installation max.	80 °C
Ambient temp. in fully flex. operation min.	-20 °C
Ambient temp. in fully flex. operation max.	60 °C

Mechanical parameters

Max. tensile load of cable	15 N/mm ²
Torsional stress	25 °/m
Bending radii min.	Acc. to DIN VDE 0298 part 3
Minimum distance with S-type directional changes	20 x D
Travel speed	max. 30 m/min

Rated voltage 3.6/6 kV

Number of cores x cross section	Part number	Conductor diameter max. mm	Outer diameter min. mm	Outer diameter nom. mm	Net weight approx. kg/km	Permissible tensile force max. N	Conductor resistance at 20°C max. Ω/km	Nom. operating capacitance μF/km	Inductance nom. mH/km	Current carrying capacity (1) A	Short Circuit Current (conductor) kA
3x 25+3x 16/3E + 3x2,5ST+ 6UEL KON	20160781	6.4	40.2	43.2	2660	1125	0.795	0.35	0.32	131	3.58
3x 35+3x 25/3E + 3x2,5ST+ 6UEL KON	20160782	7.6	44.6	47.6	3400	1575	0.565	0.39	0.31	162	5.01
3x 50+3x 25/3E + 3x2,5ST+ 6UEL KON	20160783	9.1	47.7	50.7	4000	2250	0.393	0.45	0.29	202	7.15
3x 70+3x 35/3E + 3x2,5ST+ 6UEL KON	20137581	10.9	52	55	5020	3150	0.277	0.52	0.28	250	10.01
3x 95+3x 50/3E + 3x2,5ST+ 6UEL KON	20160784	12.6	53.7	57.7	6070	4275	0.21	0.58	0.27	301	13.59
3x 120+3x 70/3E + 3x2,5ST+ 6UEL KON	20153487	14.2	61	65	7480	5400	0.164	0.64	0.26	352	17.16

Rated voltage 6/10 kV

Number of cores x cross section	Part number	Conductor diameter max. mm	Outer diameter min. mm	Outer diameter nom. mm	Net weight approx. kg/km	Permissible tensile force max. N	Conductor resistance at 20°C max. Ω/km	Nom. operating capacitance μF/km	Inductance nom. mH/km	Current carrying capacity (1) A	Short Circuit Current (conductor) kA
3x 25+3x 16/3E + 3x2,5ST+ 6UEL KON	20005060	6.4	42.9	45.9	2880	1125	0.795	0.31	0.33	135	3.58
3x 35+3x 25/3E + 3x2,5ST+ 6UEL KON	20005061	7.6	45.6	48.6	3440	1575	0.565	0.35	0.32	172	5.01
3x 50+3x 25/3E + 3x2,5ST+ 6UEL KON	20008789	9.1	48.3	52.3	3850	2250	0.393	0.4	0.3	216	7.15
3x 70+3x 35/3E + 3x2,5ST+ 6UEL KON	20008855	10.9	54.5	58.5	5350	3150	0.277	0.46	0.29	265	10.01
3x 95+3x 50/3E + 3x2,5ST+ 6UEL KON	20008403	12.6	58.2	62.2	6410	4275	0.21	0.52	0.27	319	13.59
3x 120+3x 70/3E + 3x2,5ST+ 6UEL KON	20160785	14.2	62	66	7800	5400	0.164	0.57	0.27	371	17.16

Rated voltage 8.7/15 kV

Number of cores x cross section	Part number	Conductor diameter max. mm	Outer diameter min. mm	Outer diameter nom. mm	Net weight approx. kg/km	Permissible tensile force max. N	Conductor resistance at 20°C max. Ω/km	Nom. operating capacitance μF/km	Inductance nom. mH/km	Current carrying capacity (1) A	Short Circuit Current (conductor) kA
3x25+3x16/3E +3x2,5ST+6ÜL KON		6.4	46.4	49.4	3210	1125	0.795	0.24	0.36	135	3.58
3x35+3x25/3E +3x2,5ST+6ÜL KON		7.6	48.7	52.7	3730	1575	0.565	0.27	0.34	172	5.01
3x50+3x25/3E +3x2,5ST+6ÜL KON		9.1	53.7	57.7	4700	2250	0.393	0.3	0.32	216	7.15
3x70+3x35/3E +3x2,5ST+6ÜL KON	20024471	10.9	57.9	61.9	5750	3150	0.277	0.34	0.31	265	10.01
3x95+3x50/3E +3x2,5ST+6ÜL KON	20040372	12.6	61.5	65.5	6810	4275	0.21	0.38	0.29	319	13.59
3x120+3x70/3E +3x2,5ST+6ÜL KON		14.2	67.2	71.2	8490	5400	0.164	0.42	0.29	371	17.16

Rated voltage 12/20 kV

Number of cores x cross section	Part number	Conductor diameter max. mm	Outer diameter min. mm	Outer diameter nom. mm	Net weight approx. kg/km	Permissible tensile force max. N	Conductor resistance at 20°C max. Ω/km	Nom. operating capacitance μF/km	Inductance nom. mH/km	Current carrying capacity (1) A	Short Circuit Current (conductor) kA
3x 25+3x 16/3E + 3x2,5ST+ 6UEL KON	20005062	6.4	48.7	52.7	3540	1125	0.795	0.22	0.37	135	3.58
3x 35+3x 25/3E + 3x2,5ST+ 6UEL KON	20005063	7.6	51.5	55.5	3910	1575	0.565	0.24	0.35	172	5.01
3x 50+3x 25/3E + 3x2,5ST+ 6UEL KON	20005064	9.1	56.6	60.6	4820	2250	0.393	0.27	0.33	216	7.15
3x 70+3x 35/3E + 3x2,5ST+ 6UEL KON	20081491	10.9	61.2	65.2	6150	3150	0.277	0.31	0.32	265	10.01
3x 95+3x 50/3E + 3x2,5ST+ 6UEL KON	20113405	12.6	66.3	70.3	7470	4275	0.21	0.34	0.3	319	13.59
3x 120+3x 70/3E + 3x2,5ST+ 6UEL KON	20015054	14.2	70.1	74.1	8580	5400	0.164	0.38	0.29	371	17.16

Rated voltage 14/25 kV

Number of cores x cross section	Conductor diameter max. mm	Outer diameter min. mm	Outer diameter nom. mm	Net weight approx. kg/km	Permissible tensile force max. N	Conductor resistance at 20°C max. Ω/km	Nom. operating capacitance μF/km	Inductance nom. mH/km	Current carrying capacity (1) A	Short Circuit Current (conductor) kA
3x 25+3x 16/3E + 3x2,5ST+ 6UEL KON	6.4	54.6	58.6	4100	1125	0.795	0.19	0.4	135	3.58
3x 35+3x 25/3E + 3x2,5ST+ 6UEL KON	7.6	57.1	61.1	4640	1575	0.565	0.21	0.37	172	5.01
3x 50+3x 25/3E + 3x2,5ST+ 6UEL KON	9.1	61	65	5550	2250	0.393	0.23	0.35	216	7.15
3x 70+3x 35/3E + 3x2,5ST+ 6UEL KON	10.9	66.6	70.6	6860	3150	0.277	0.26	0.33	265	10.01
3x 95+3x 50/3E + 3x2,5ST+ 6UEL KON	12.6	70.2	74.2	8110	4275	0.21	0.29	0.32	319	13.59
3x 120+3x 70/3E + 3x2,5ST+ 6UEL KON	14.2	73.9	77.9	9450	5400	0.164	0.32	0.31	371	17.16

Rated voltage 18/30 kV

Number of cores x cross section	Conductor diameter max. mm	Outer diameter min. mm	Outer diameter nom. mm	Net weight approx. kg/km	Permissible tensile force max. N	Conductor resistance at 20°C max. Ω/km	Nom. operating capacitance μF/km	Inductance nom. mH/km	Current carrying capacity (1) A	Short Circuit Current (conductor) kA
3x 25+3x 16/3E + 3x2,5ST+ 6UEL KON	6.4	58	62	4490	1125	0.795	0.17	0.42	135	3.58
3x 35+3x 25/3E + 3x2,5ST+ 6UEL KON	7.6	60.7	64.7	5060	1575	0.565	0.18	0.39	172	5.01
3x 50+3x 25/3E + 3x2,5ST+ 6UEL KON	9.1	66.1	70.1	6220	2250	0.393	0.2	0.37	216	7.15
3x 70+3x 35/3E + 3x2,5ST+ 6UEL KON	10.9	70	74	7330	3150	0.277	0.23	0.35	265	10.01
3x 95+3x 50/3E + 3x2,5ST+ 6UEL KON	12.6	73.9	77.9	8660	4275	0.21	0.25	0.33	319	13.59
3x 120+3x 70/3E + 3x2,5ST+ 6UEL KON	14.2	78.6	83.6	10250	5400	0.164	0.27	0.32	371	17.16

TENAX HTT

Medium voltage reeling cable for use with TBMs



Application

For the connection of electrical equipment, in mines and underground excavations with hazardous environments under particularly high mechanical loads, e.g. high-voltage transformers on power lines in underground mining and tunneling. The flexible cable design allows for movement of the equipment during operation and even slow reeling operations

Global data

Brand	TENAX-HTT
Type designation	(N)TSCGEW0EU
Standard	Based on DIN VDE 0250-813
Certifications / Approvals	Fire Certificate of Russian Federation GOST K GOST B

Design features

Conductor	Finely stranded copper conductor (class 5) according to DIN VDE 0295
PE-Conductor	Spinning of tinned annealed copper wires according to IEC 60228 (class 5)
Insulation	Rubber, Compound type: 3GI3 according to DIN VDE 0207 part 20
Core identification	According to DIN VDE 0250 Pt. 813, Color: Natural
Inner sheath	Rubber, Compound type: GM1B according to DIN VDE 0207 part 21
Reinforcement	Polyester anti-torsion braid between the jackets embedded
Outer sheath	Rubber, Compound type: 5GM5 according to DIN VDE 0207 part 21, Color: Red

Electrical parameters

Rated voltage	6/10 kV	8.7/15 kV	12/20 kV	14/25 kV	18/30 kV
Maximum permissible operating voltage AC	6.9/12 kV	10.4/18 kV	13.9/24 kV	17.3/30 kV	20.8/36 kV
Maximum permissible operating voltage DC	9/18 kV	13.5/27 kV	18/36 kV	22.5/45 kV	27/54 kV
AC test voltage	17 kV	24 kV	29 kV	36 kV	43 kV

Chemical parameters

Resistance to fire	EN 60332-1-2, IEC 60332-1-2
Resistance to oil	EN 60811-404, IEC 60811-404

Thermal parameters

Max. permissible temperature at conductor	90 °C
Max. short circuit temperature of the conductor	250 °C
Ambient temperature for fix installation min.	-40 °C
Ambient temperature for fix installation max.	80 °C
Ambient temp. in fully flex. operation min.	-25 °C
Ambient temp. in fully flex. operation max.	60 °C

Mechanical parameters

Max. tensile load of cable	15 N/mm ²
Torsional stress	100 °/m
Bending radii min.	Acc. to DIN VDE 0298 part 3
Travel speed	max. 30 m/min

Rated voltage 6/10 kV

Number of cores x cross section	Conductor diameter max. mm	Outer diameter min. mm	Outer diameter nom. mm	Net weight approx. kg/km	Permissible tensile force max. N	Conductor resistance at 20°C max. Ω/km	Nom. operating capacitance μF/km	Inductance nom. mH/km	Current carrying capacity (1) A	Short Circuit Current (conductor) kA
3x25x3x16/3E	6.2	45.6	49.1	2975	1125	0.78	0.23	0.37	135	3.58
3x35+3x25/3E	7.8	50.8	55.3	3825	1575	0.554	0.27	0.34	172	5.01
3x50+3x25/3E	9.6	54.7	59.2	4525	2250	0.386	0.31	0.32	216	7.15
3x70+3x35/3E	10.6	56.9	61.4	5325	3150	0.272	0.34	0.31	265	10.01
3x95+3x50/3E	12.6	63.4	67.9	7075	4275	0.206	0.38	0.29	319	13.59
3x120+3x70/3E	14.8	68.6	73.1	8550	5400	0.161	0.44	0.28	371	17.16
3x150+3x70/3E	16	71.1	75.6	9300	6750	0.129	0.46	0.28	428	21.45

Rated voltage 8.7/15 kV

Number of cores x cross section	Conductor diameter max. mm	Outer diameter min. mm	Outer diameter nom. mm	Net weight approx. kg/km	Permissible tensile force max. N	Conductor resistance at 20°C max. Ω/km	Nom. operating capacitance μF/km	Inductance nom. mH/km	Current carrying capacity (1) A	Short Circuit Current (conductor) kA
3x25x3x16/3E	6.2	51.7	56.2	3625	1125	0.78	0.19	0.39	135	3.58
3x35+3x25/3E	7.8	55.2	59.7	4275	1575	0.554	0.22	0.36	172	5.01
3x50+3x25/3E	9.6	59.1	63.6	5050	2250	0.386	0.25	0.34	216	7.15
3x70+3x35/3E	10.6	63.4	67.9	6250	3150	0.272	0.27	0.33	265	10.01
3x95+3x50/3E	12.6	68.2	72.7	7775	4275	0.206	0.31	0.31	319	13.59
3x120+3x70/3E	14.8	75.2	79.7	9675	5400	0.161	0.35	0.3	371	17.16
3x150+3x70/3E	16	77.7	82.2	10375	6750	0.129	0.37	0.29	428	21.45
3x185+3x95/3E	17.7	78	82	12680	13875	0.106	0.4	0.29	488	26.46

Rated voltage 12/20 kV

Number of cores x cross section	Conductor diameter max. mm	Outer diameter min. mm	Outer diameter nom. mm	Net weight approx. kg/km	Permissible tensile force max. N	Conductor resistance at 20°C max. Ω/km	Nom. operating capacitance μF/km	Inductance nom. mH/km	Current carrying capacity (1) A	Short Circuit Current (conductor) kA
3x25x3x16/3E	6.2	56	60.5	4125	1125	0.78	0.17	0.41	135	3.58
3x35+3x25/3E	7.8	59.9	64.4	4875	1575	0.554	0.19	0.38	172	5.01
3x50+3x25/3E	9.6	65.6	70.1	5950	2250	0.386	0.22	0.36	216	7.15
3x70+3x35/3E	10.6	68.2	72.7	6925	3150	0.272	0.23	0.35	265	10.01
3x95+3x50/3E	12.6	74.3	78.8	8775	4275	0.206	0.26	0.33	319	13.59
3x120+3x70/3E	14.8	79.5	84	10400	5400	0.161	0.29	0.31	371	17.16
3x150+3x70/3E	16	82	86.5	11175	6750	0.129	0.31	0.31	428	21.45

Rated voltage 14/25 kV

Number of cores x cross section	Conductor diameter max. mm	Outer diameter min. mm	Outer diameter nom. mm	Net weight approx. kg/km	Permissible tensile force max. N	Conductor resistance at 20°C max. Ω/km	Nom. operating capacitance μF/km	Inductance nom. mH/km	Current carrying capacity (1) A	Short Circuit Current (conductor) kA
3x25x3x16/3E	6.2	63.5	68	5150	1125	0.78	0.15	0.44	135	3.58
3x35+3x25/3E	7.8	67.3	71.8	5975	1575	0.554	0.17	0.41	172	5.01
3x50+3x25/3E	9.6	71.2	75.7	6850	2250	0.386	0.19	0.38	216	7.15
3x70+3x35/3E	10.6	75.6	80.1	8150	3150	0.272	0.2	0.37	265	10.01
3x95+3x50/3E	12.6	79.9	84.4	9800	4275	0.206	0.22	0.35	319	13.59
3x120+3x70/3E	14.8	86.9	91.4	11875	5400	0.161	0.25	0.33	371	17.16
3x150+3x70/3E	16	89.4	93.9	12700	6750	0.129	0.27	0.32	428	21.45

Rated voltage 18/30 kV

Number of cores x cross section	Conductor diameter max. mm	Outer diameter min. mm	Outer diameter nom. mm	Net weight approx. kg/km	Permissible tensile force max. N	Conductor resistance at 20°C max. Ω/km	Nom. operating capacitance μF/km	Inductance nom. mH/km	Current carrying capacity (1) A	Short Circuit Current (conductor) kA
3x25x3x16/3E	6.2	68.6	73.1	5950	1125	0.78	0.13	0.46	135	3.58
3x35+3x25/3E	7.8	74.3	78.8	7125	1575	0.554	0.15	0.43	172	5.01
3x50+3x25/3E	9.6	78.2	82.7	8050	2250	0.386	0.17	0.4	216	7.15
3x70+3x35/3E	10.6	80.8	85.3	9100	3150	0.272	0.18	0.39	265	10.01
3x95+3x50/3E	12.6	86.9	91.4	11150	4275	0.206	0.2	0.37	319	13.59
3x120+3x70/3E	14.8	91.7	96.2	12775	5400	0.161	0.22	0.35	371	17.16
3x150+3x70/3E	16	94.2	98.7	13600	6750	0.129	0.23	0.34	428	21.45

Underground Mining



CABLES FOR SEMI-FIXED INSTALLATION

	PROTOMONT Festoon	SUPROMONT (N)3GHSSYCY	PROTOMONT NSSHOEU../3E	PROTOMONT (EMV-FC)
Application	MV semi-fixed	MV semi-fixed	LV semi-fixed	LV frequency converter cable
Permissible tensile force	15N/mm ²	15N/mm ²	15N/mm ²	15N/mm ²
Cable design	acc. to VDE	based on VDE	acc. to VDE	acc. to VDE
Special cable design features	Double screen technology	Double screen technology	Concentric core screens	Excellent EMC properties
Stability against torsion	+/- 100°/m	+/- 50°/m	+/- 25°/m	+/- 25°/m
Sheath quality	5GM5*	PVC YM5	5GM5*	5GM5
Reversed bending stability	+++	++	++	++
Temperature range in fully flexible operation	-25°C to +60°C	+5°C to +60°C	-25°C to +60°C	-25°C to +60°C -45°C to +60°C
Approvals	WUG-Poland, MA-China, Rostekhnadzor, Fire certificate, Gost K, Gost B	VDE certificate of conformity	MSHA P-189-3, MA China, TR-certificate, Fire certificate, Gost K, Gost B, Bosnia	MSHA P-189-3, TR-certificate, Fire certificate, Gost K, Gost B, Bosnia

* special compound for the Chinese version

PROTOMONT Festoon Underground Festoon cable



Application

As power feeder cable in underground mines and in tunnel sites. The cables are used in underground festoon systems for the power supply of mobile transformer and shiftable units in underground mining applications.

Global data

Brand	PROTOMONT Festoon
Type designation	NTSKCGECWOEU
Standard	DIN VDE 0250-813
Certifications / Approvals	MA - China WUG - Poland Fire Certificate of Russian Federation GOST K GOST B

Design features

Conductor	Finely stranded copper conductor, tinned (Class 5)
Insulation	PROTOLON, Basic material: EPR, Compound type: 3GI3
Electrical field control	Inner semiconductive layer of semiconductive rubber, outer semiconductive layer of tapes
Core identification	Power cores: Natural color, Control cores: Blue
Arrangement of PE-conductor	Concentric spinning of copper wires over each control core element in the outer interstices
Inner sheath	Basic material: EPR, Compound type: GM1B
Monitoring conductor	Semi-conductive tape and open-lay spinning of steel/copper wires
Outer sheath	PROTOFIRM, Basic material: synthetic elastomer compound e.g. CR, Compound type: 5GM5, Color: Red

Electrical parameters

Rated voltage	3.6/6 kV
Maximum permissible operating voltage AC	4.2/7.2 kV
Maximum permissible operating voltage DC	5.4/10.8 kV
AC test voltage	11 kV

Chemical parameters

Resistance to fire	EN 60332-1-2; IEC 60332-1-2
Resistance to oil	EN 60811-404, IEC 60811-404.
Weather resistance	Unrestricted use outdoors and indoors, resistant to ozone, UV and moisture

Thermal parameters

Max. permissible temperature at conductor	90 °C
Max. short circuit temperature of the conductor	250 °C
Ambient temperature for fix installation min.	-40 °C
Ambient temperature for fix installation max.	80 °C
Ambient temp. in fully flex. operation min.	-25 °C
Ambient temp. in fully flex. operation max.	60 °C

Mechanical parameters

Max. tensile load of cable	15 N/mm ²
Bending radii min.	Acc. to DIN VDE 0298 part 3

Number of cores x cross section	Part number	Conductor diameter max. mm	Outer diameter min. mm	Outer diameter max. mm	Net weight approx. kg/km	Permissible tensile force max. N	Conductor resistance at 20°C max. Ω/km	Nom. operating capacitance μF/km	Inductance nom. mH/km	Current carrying capacity (1) A	Short Circuit Current (conductor) kA
3x 35 + 3x(1,5ST KON + 25/3KON) + 6UELKON	20005043	8.2	47.6	50.6	3750	1575	0.565	0.31	0.32	162	5.01
3x 50 + 3x(1,5ST KON + 25/3KON) + 6UELKON	20005040	9.8	50.6	54.6	4430	2250	0.393	0.35	0.31	202	7.15
3x 70 + 3x(1,5ST KON + 35/3KON) + 6UELKON	20005041	11.3	55	59	5500	3150	0.277	0.39	0.3	250	10.01
3x 95 + 3x(1,5ST KON + 50/3KON) + 6UELKON	20005042	13.4	60.3	64.3	6700	4275	0.21	0.45	0.28	301	13.59
3x 120+3x(1,5ST KON + 70/3KON) + 6UELKON	20007844	15.1	65.8	69.8	8150	5400	0.164	0.49	0.27	352	17.16
3x 150+3x(1,5ST KON + 70/3KON) + 6UELKON	20053570	16.8	69.7	73.7	9420	6750	0.132	0.54	0.27	404	21.45
3x 185+3x(1,5ST KON + 95/3KON) + 6UELKON	20080424	19	70	74	12770	8325	0.108	0.59	0.26	461	26.46

SUPROMONT (N)3GHSSYCY

Rubber insulated medium-voltage flexible cable for underground use



Application

As feeder cable for power supply of shiftable MV equipment up to $U_0/U=12/20$ kV, e.g. compressure resistant transformers, for underground mining applications as well as for tunnel sites.

Global data

Brand	SUPROMONT Rubber
Type designation	(N)3GHSSYCY
Standard	based on DIN VDE 0250 part 605
Certifications / Approvals	VDE certificate of conformity

Design features

Conductor	Finely stranded copper conductor, untinned (class 5)
PE-Conductor	Individually laid-up concentrically around each main core
Insulation	PROTOLON, Basic material: EPR, Compound type: Special compound, better 3GI3
Electrical field control	Inner and outer semiconductive layer of semiconductive rubber, for 6kV outer semiconductive layer only
Core identification	Main cores: Natural color with black semiconductive layer, Control cores: Black with white digits
Core arrangement	Three main cores laid-up, one control core in each outer interstice
Monitoring conductor	Conductive tape and overall concentric copper wire spinning
Intermediate sheath	PVC based plastic compound, Compound type: DMV6
Reinforcement	Braid of galvanized steel wires
Outer sheath	PVC-based thermoplastic compound, Compound type: DMV6, Color: Red

Electrical parameters

Rated voltage	3.6/6 kV	6/10 kV	8.7/15 kV	12/20 kV	14/25 kV	18/30 kV	20/35 kV
Maximum permissible operating voltage AC	4.2/7.2 kV	6.9/12 kV	10.4/18 kV	13.9/24 kV	17.3/30 kV	20.8/36 kV	24.2/42 kV
Maximum permissible operating voltage DC	5.4/10.8 kV	9/18 kV	13.5/27 kV	18/36 kV	22.5/45 kV	27/54 kV	31.5/63 kV
AC test voltage	11 kV	17 kV	24 kV	29 kV	36 kV	43 kV	50 kV

Chemical parameters

Resistance to fire	EN 60332-1-2, IEC 60332-1-2
Weather resistance	Unrestricted use indoors and in underground mines according to DIN VDE 0118, resistant to ozone and moisture

Thermal parameters

Max. permissible temperature at conductor	90 °C
Max. short circuit temperature of the conductor	250 °C
Ambient temperature for fix installation min.	-40 °C
Ambient temperature for fix installation max.	80 °C
Ambient temp. in fully flex. operation min.	5 °C
Ambient temp. in fully flex. operation max.	60 °C

Mechanical parameters

Max. tensile load of cable	15 N/mm ²
Bending radii min.	Acc. to DIN VDE 0298 part 3

Rated voltage 3.6/6 kV

Number of cores x cross section	Part number	Conductor diameter max. mm	Outer diameter min. mm	Net weight approx. kg/km	Permissible tensile force max. N	Conductor resistance at 20°C max. Ω/km	Nom. operating capacitance μF/km	Inductance nom. mH/km	Current carrying capacity (1) A	Short Circuit Current (conductor) kA
3x 25+ 3x16/3E+ 3x2,5ST+UEL		6.4	44	3468	1125	0.78	0.36	0.32	131	3.58
3x 35+ 3x16/3E+ 3x2,5ST+UEL		7.6	46.6	3967	1575	0.554	0.41	0.3	162	5.01
3x 50+ 3x25/3E+ 3x2,5ST+UEL	20042591	9.1	49.6	4733	2250	0.386	0.47	0.29	202	7.15
3x 70+ 3x35/3E+ 3x2,5ST+UEL		10.8	53.2	5720	3150	0.272	0.53	0.28	250	10.01
3x 95+ 3x50/3E+ 3x2,5ST+UEL	20049961	12.7	58.8	6993	4275	0.206	0.61	0.27	301	13.59
3 x 120+ 3x70/3E + 3x2,5ST+UEL		14.3	62.7	8311	5400	0.161	0.67	0.26	352	17.16
3 x 150+ 3x70/3E + 3x2,5ST+UEL		16	67.6	9634	6750	0.129	0.74	0.25	404	21.45
3 x 185+ 3x120/3E + 3x2,5ST+UEL		17.7	71.7	11202	8325	0.106	0.8	0.25	461	26.46

(1) Ambient temperature 30°C

Rated voltage 6/10 kV

Number of cores x cross section	Part number	Conductor diameter max. mm	Outer diameter min. mm	Net weight approx. kg/km	Permissible tensile force max. N	Conductor resistance at 20°C max. Ω/km	Nom. operating capacitance μF/km	Inductance nom. mH/km	Current carrying capacity (1) A	Short Circuit Current (conductor) kA
3x 25+ 3x16/3E+ 3x2,5ST+UEL		6.4	45.3	3610	1125	0.78	0.32	0.33	135	3.58
3x 35+ 3x16/3E+ 3x2,5ST+UEL	20005081	7.6	47.9	4115	1575	0.554	0.36	0.31	172	5.01
3x 50+ 3x25/3E+ 3x2,5ST+UEL	20005082	9.1	50.9	4903	2250	0.386	0.42	0.3	216	7.15
3x 70+ 3x35/3E+ 3x2,5ST+UEL	20133422	10.8	54.5	5886	3150	0.272	0.47	0.28	265	10.01
3x 95+ 3x50/3E+ 3x2,5ST+UEL	20005083	12.7	60.1	7175	4275	0.206	0.54	0.27	319	13.59
3x 120+ 3x70/3E+ 3x2,5ST+UEL	20005084	14.3	64	8498	5400	0.161	0.59	0.26	371	17.16
3 x 150+ 3x70/3E + 3x2,5ST+UEL		16	68.9	9841	6750	0.129	0.66	0.25	428	21.45
3 x 185+ 3x120/3E + 3x2,5ST+UEL		17.7	73	11408	8325	0.106	0.74	0.25	488	26.46

(1) Ambient temperature 30°C

Rated voltage 8.7/15 kV

Number of cores x cross section	Conductor diameter max. mm	Outer diameter min. mm	Net weight approx. kg/km	Permissible tensile force max. N	Conductor resistance at 20°C max. Ω/km	Nom. operating capacitance μF/km	Inductance nom. mH/km	Current carrying capacity (1) A	Short Circuit Current (conductor) kA
3x 35+ 3x16/3E+ 3x2,5ST+UEL	7.6	50.4	4481	1575	0.554	0.29	0.33	172	5.01
3x 50+ 3x25/3E+ 3x2,5ST+UEL	9.1	53.9	5300	2250	0.386	0.33	0.31	216	7.15
3x 70+ 3x35/3E+ 3x2,5ST+UEL	10.8	57.6	6280	3150	0.272	0.38	0.3	265	10.01
3x 95+ 3x50/3E+ 3x2,5ST+UEL	12.7	63.1	7652	4275	0.206	0.43	0.29	319	13.59
3x 120+ 3x70/3E+ 3x2,5ST+UEL	14.3	67	8938	5400	0.161	0.47	0.28	371	17.16
3 x 150+ 3x70/3E + 3x2,5ST+UEL	16	72	10398	6750	0.129	0.54	0.27	428	21.45
3 x 185+ 3x120/3E + 3x2,5ST+UEL	17.7	75.6	11865	8325	0.106	0.58	0.26	488	26.46

(1) Ambient temperature 30°C

Rated voltage 12/20 kV

Number of cores x cross section	Part number	Conductor diameter max. mm	Outer diameter min. mm	Net weight approx. kg/km	Permissible tensile force max. N	Conductor resistance at 20°C max. Ω/km	Nom. operating capacitance μF/km	Inductance nom. mH/km	Current carrying capacity (1) A	Short Circuit Current (conductor) kA
3x 35+ 3x16/3E+ 3x2,5ST+UEL	20015843	7.6	53.7	4973	1575	0.554	0.25	0.35	172	5.01
3x 50+ 3x25/3E+ 3x2,5ST+UEL	20007713	9.1	56.9	5727	2250	0.386	0.28	0.33	216	7.15
3x 70+ 3x35/3E+ 3x2,5ST+UEL		10.8	61.1	6926	3150	0.272	0.32	0.31	265	10.01
3x 95+ 3x50/3E+ 3x2,5ST+UEL	20111613	12.7	66.1	8121	4275	0.206	0.36	0.3	319	13.59
3x 120+ 3x70/3E+ 3x2,5ST+UEL		14.3	70	9450	5400	0.161	0.39	0.29	371	17.16
3 x 150+ 3x70/3E + 3x2,5ST+UEL		16	75	10932	6750	0.129	0.43	0.28	428	21.45
3 x 185+ 3x120/3E + 3x2,5ST+UEL		17.7	78.7	12417	8325	0.106	0.47	0.27	488	26.46

(1) Ambient temperature 30°C

Rated voltage 14/25 kV

Number of cores x cross section	Conductor diameter max. mm	Outer diameter min. mm	Net weight approx. kg/km	Permissible tensile force max. N	Conductor resistance at 20°C max. Ω/km	Nom. operating capacitance μF/km	Inductance nom. mH/km	Current carrying capacity (1) A	Short Circuit Current (conductor) kA
3x 35+ 3x16/3E+ 3x2,5ST+UEL	7.6	57.6	5502	1575	0.554	0.21	0.37	162	5.01
3x 50+ 3x25/3E+ 3x2,5ST+UEL	9.1	61.4	6517	2250	0.386	0.24	0.35	202	7.15
3x 70+ 3x35/3E+ 3x2,5ST+UEL	10.8	65	7526	3150	0.272	0.27	0.33	250	10.01
3x 95+ 3x50/3E+ 3x2,5ST+UEL	12.7	70	8790	4275	0.206	0.3	0.32	301	13.59
3x 120+ 3x70/3E+ 3x2,5ST+UEL	14.3	73.9	10137	5400	0.161	0.33	0.3	352	17.16
3 x 150+ 3x70/3E + 3x2,5ST+UEL	16	78.9	11679	6750	0.129	0.36	0.29	404	21.45
3 x 185+ 3x95/3E + 3x2,5ST+UEL	17.7	82.5	13095	8325	0.106	0.39	0.29	461	26.46

(1) Ambient temperature 30°C

Rated voltage 18/30 kV

Number of cores x cross section	Conductor diameter max. mm	Outer diameter min. mm	Net weight approx. kg/km	Permissible tensile force max. N	Conductor resistance at 20°C max. Ω/km	Nom. operating capacitance μF/km	Inductance nom. mH/km	Current carrying capacity (1) A	Short Circuit Current (conductor) kA
3x 50+ 3x25/3E+ 3x2,5ST+UEL	9.1	67.4	7487	2250	0.386	0.2	0.37	202	7.15
3x 70+ 3x35/3E+ 3x2,5ST+UEL	10.8	71.1	8549	3150	0.272	0.22	0.35	250	10.01
3x 95+ 3x50/3E+ 3x2,5ST+UEL	12.7	76.5	10091	4275	0.206	0.25	0.34	301	13.59
3x 120+ 3x70/3E+ 3x2,5ST+UEL	14.3	79.9	11268	5400	0.161	0.27	0.33	352	17.16
3 x 150+ 3x70/3E + 3x2,5ST+UEL	16	84.4	12887	6750	0.129	0.29	0.31	404	21.45

(1) Ambient temperature 30°C

Rated voltage 20/35 kV

Number of cores x cross section	Conductor diameter max. mm	Outer diameter min. mm	Net weight approx. kg/km	Permissible tensile force max. N	Conductor resistance at 20°C max. Ω/km	Nom. operating capacitance μF/km	Inductance nom. mH/km	Current carrying capacity (1) A	Short Circuit Current (conductor) kA
3x 50+ 3x25/3E+ 3x2,5ST+UEL	9.1	71.3	8129	2250	0.386	0.18	0.39	202	7.15
3x 70+ 3x35/3E+ 3x2,5ST+UEL	10.8	75.4	9460	3150	0.272	0.2	0.37	250	10.01
3x 95+ 3x50/3E+ 3x2,5ST+UEL	12.7	80.4	10813	4275	0.206	0.22	0.35	301	13.59
3x 120+ 3x70/3E+ 3x2,5ST+UEL	14.3	83.3	12069	5400	0.161	0.24	0.34	352	17.16

(1) Ambient temperature 30°C

PROTOMONT NSSHOEU .../3E

Rubber-sheathed flexible cable



Application

The cables are suitable for fixed installation and flexible operation as power supply cables to motors, distribution boards, etc., for underground mining applications, for tunnel building applications, for open-cast mining applications, for use in quarries and similar applications. Permitted for applications according to DIN VDE 0118.

Global data

Brand	PROTOMONT .../3E
Type	PROTOMONT NSSHOEU.../3E 0.6/1 kV
Standard	DIN VDE 0250-812
Certifications / Approvals	MA – China (special design) MSHA P-189-3 BAS Bosnia-Herzegovina Fire Certificate of Russian Federation TR-Certificate GOST K GOST B

Design features

Conductor	Copper conductor, untinned, finely stranded (class 5)
PE-Conductor	Individual-concentric or overall concentric spinning of untinned copper wires
Insulation	PROTOLON, Basic material: EPR, Compound type: 3GI3
Core identification	Up to 5 cores colored, Core colors: Black, Blue, Brown, Black, Grey
Core arrangement	Three, four of five cores laid-up
Description of spinning	Closed-lay spinning of steel/copper wires in a vulcanized bond between inner and outer sheath in case of NSSHOEU.../KON cables
Inner sheath	Vulcanized rubber inner sheath, Basic material: EPR, Compound type: GM1B
Outer sheath	PROTOFIRM, Basic material: Chlorinated rubber, Compound type: 5GM5, Color: Yellow

Electrical parameters

Rated voltage	U ₀ /U = 0,6/1 kV, also permitted for U ₀ /U = 640/1140V
Maximum permissible operating voltage AC	0.7/1.2 kV
Maximum permissible operating voltage DC	0.9/1.8 kV
AC test voltage	3 kV

Chemical parameters

Resistance to fire	EN 60332-1-2; IEC 60332-1-2
Resistance to oil	EN 60811-404, IEC 60811-404
Weather resistance	Unrestricted use outdoors and indoors, resistant to ozone and moisture

Thermal parameters

Max. permissible temperature at conductor	90 °C
Max. short circuit temperature of the conductor	250 °C
Ambient temperature for fix installation min.	-40 °C
Ambient temperature for fix installation max.	80 °C
Ambient temp. in fully flex. operation min.	-25 °C
Ambient temp. in fully flex. operation max.	60 °C

Mechanical parameters

Max. tensile load of cable	15 N/mm ²
Bending radii min.	Acc. to DIN VDE 0298 part 3

Number of cores x cross section	Part number	Conductor diameter max. mm	Outer diameter min. mm	Outer diameter max. mm	Net weight approx. kg/km	Permissible tensile force max. N	Conductor resistance at 20°C max. Ω/km	Nom. operating capacitance µF/km	Inductance nom. mH/km	Current carrying capacity (1) A	Short Circuit Current (conductor) kA
PROTOMONT NSSHOEU.../3E											
3x1,5+3x1,5/3E	20005094	1.6	12.5	14.1	250	68	13.3	0.21	0.33	23	0.22
3x2,5+3x2,5/3E	20005095	2	13.6	15.2	327	113	7.98	0.24	0.32	30	0.36
3x4+3x4/3E	20039860	2.4	16.1	18.1	466	180	4.95	0.26	0.31	41	0.57
3x6+3x6/3E	20005096	2.9	17.4	19.4	560	270	3.3	0.3	0.29	53	0.86
3x10+3x10/3E	20005097	4	20.3	22.3	751	450	1.91	0.33	0.28	74	1.43
3x16+3x16/3E	20005098	5	23.9	25.9	1100	720	1.21	0.4	0.27	99	2.29
3x25+3x16/3E	20040501	6.4	27.7	30.7	1565	1125	0.78	0.42	0.26	131	3.58
3x35+3x16/3E	20039858	6.5	30.1	33.1	1935	1575	0.554	0.49	0.25	162	5.01
3x50+3x25/3E	20008752	9	35.9	38.9	2725	2250	0.386	0.51	0.25	202	7.15
3x70+3x35/3E	20007207	10.7	40.6	43.6	3725	3150	0.272	0.6	0.24	250	10.01
3x95+3x50/3E	20005099	12.3	45.5	48.5	4725	4275	0.206	0.61	0.24	301	13.6
3x120+3x70/3E	20015058	14.3	51.9	55.9	6160	5400	0.161	0.7	0.23	352	17.16
3x150+3x70/3E	20006978	16	56.2	60.2	7275	6750	0.129	0.7	0.23	404	21.45
3x185+3x95/3E	20006979	17.7	62.8	66.8	9025	8325	0.106	0.7	0.23	461	26.46
3x240+3x120/3E	20006980	20.3	69.6	73.6	11500	10800	0.08	0.71	0.22	544	34.32
PROTOMONT NSSHOEU.../3E+ST											
3x2,5+3x2,5/3E +3x1,5ST	20005100	2	17.1	19.1	510	113	7.98	0.24	0.32	30	0.36
3x4+3x4/3E +3x1,5ST	20025110	2.4	17.8	19.8	552	180	4.95	0.26	0.31	41	0.57
3x6+3x6/3E +3x1,5ST	20005101	2.9	18.4	20.4	628	270	3.3	0.3	0.29	53	0.86
3x10+3x10/3E +3x2,5ST	20005102	4	22.1	24.1	934	450	1.91	0.33	0.28	74	1.43
3x16+3x16/3E +3x2,5ST	20005103	5	23.9	25.9	1200	720	1.21	0.4	0.27	99	2.29
3x25+3x16/3E +3x2,5ST	20005104	6.4	27.7	30.7	1640	1125	0.78	0.42	0.26	131	3.58
3x35+3x16/3E +3x2,5ST	20005105	7.5	30.1	33.1	2120	1575	0.554	0.49	0.25	162	5.01
3x50+3x25/3E +3x2,5ST	20005106	9	35.9	38.9	2800	2250	0.386	0.51	0.25	202	7.15
3x70+3x35/3E +3x2,5ST	20005107	10.7	40.6	43.6	3800	3150	0.272	0.6	0.24	250	10.01
3x95+3x50/3E +3x2,5ST	20005108	12.3	45.5	48.5	4800	4275	0.206	0.61	0.24	301	13.6
3x120+3x70/3E +3x2,5ST	20005109	14.3	51.9	55.9	6260	5400	0.161	0.69	0.23	352	17.16
3x150+3x70/3E +3x2,5ST	20060692	16	56.2	60.2	7070	6750	0.129	0.7	0.23	404	21.45
3x185+3x95/3E +3x2,5ST	20007785	17.7	62.8	66.8	9100	8325	0.106	0.7	0.23	461	26.46
3x240+3x120/3E +3x2,5ST	20100480	20.3	69.6	73.6	11500	10800	0.08	0.71	0.22	544	34.32
PROTOMONT NSSHOEU.../KON											
3x1,5/1,5KON		1.6	12.2	13.8	250	68	13.7	0.21	0.33	23	0.22
3x2,5/2,5KON	20004908	1.9	13.7	15.3	330	113	8.21	0.24	0.32	30	0.36
3x4/4KON		2.4	16.1	18.1	450	180	4.95	0.27	0.3	41	0.57
4x6/6KON		2.9	18.8	20.8	645	360	3.39	0.32	0.29	53	0.86
4x10/10KON		4.8	23.1	25.1	1010	600	1.95	0.34	0.28	74	1.43
4x16/16KON		5.7	27.1	30.1	1520	960	1.24	0.44	0.26	99	2.29
5x2,5/2,5KON	20004909	1.9	18.8	20.8	465	188	8.21	0.24	0.32	30	0.36
5x4/4KON	20004910	2.4	18.2	20.2	595	300	5.09	0.27	0.3	41	0.57
5x6/6KON	20024743	2.9	21.3	23.3	820	450	3.39	0.32	0.29	53	0.86

PROTOMONT (EMV-FC) (N)SSHCOEU

Frequency converter cables



Application

The cables are suitable for fixed installation and flexible operation as motor power supply cables for frequency converter controlled drives in the mining industry, on construction sites and similar applications, with heavy mechanical stresses. For laying on material handling equipment (even with continuous movement such as in cable booms or as connection between upper and lower car). Can also be applied in water with up to 40°C; in wastewater up to approximately 10 m depth, in fresh water and salt water up to 500 m depth.

Global data

Brand	PROTOMONT EMV-FC
Type designation	(N)SSHCOEU
Standard	Based on DIN VDE 0250 part 812
Certifications / Approvals	MSHA P-189-3 Fire Certificate of Russian Federation TR-Certificate GOST K GOST B

Design features

Conductor	Finely stranded copper conductor, tinned (class 5) according to DIN VDE 0295
Insulation	PROTOLON, Basic material: EPR, Compound type: 3GI3
Core identification	Natural coloring with black figures
Core arrangement	Three power cores laid up with the protective earth conductors split into three in the outer interstices
Screen	EMC optimized, concentric braid of tinned copper wires
Inner sheath	Vulcanized rubber compound, Basic material: EPR, Compound type: GM1B
Outer sheath	PROTOFIRM, synthetic elastomer compound e.g. CR, Compound type: 5GM5, Color: Yellow

Electrical parameters

Rated voltage	$U_0/U = 0,6/1$ kV, also permitted for $U_0/U = 640/1140$ V
Maximum permissible operating voltage AC	0.7/1.2 kV
Maximum permissible operating voltage DC	0.9/1.8 kV
AC test voltage	5 kV

Chemical parameters

Resistance to fire	EN 60332-1-2, IEC 60332-1-2
Resistance to oil	Given in accordance with EN 60811-404, IEC 60811-404
Weather resistance	Unrestricted use outdoors and indoors, resistant to ozone and moisture

Thermal parameters

Max. permissible temperature at conductor	90 °C
Max. short circuit temperature of the conductor	250 °C
Ambient temperature for fix installation min.	-40 °C
Ambient temperature for fix installation max.	80 °C
Ambient temperature in fully flexible operation min.	-25 °C
Ambient temperature in fully flexible operation max.	60 °C

Mechanical parameters

Tensile load on the conductor max .	15 N/mm ²
Torsional stress	25 °/m
Bending radii min.	Acc. to DIN VDE 0298 part 3

Number of cores x cross section	Part number	Conductor diameter max. mm	Outer diameter min. mm	Outer diameter max. mm	Net weight approx. kg/km	Permissible tensile force max. N	Conductor resistance at 20°C max. Ω/km	Nom. operating capacitance μF/km	Inductance nom. mH/km	Current carrying capacity (1) A	Short Circuit Current (conductor) kA
3 x 16 + 3 x 2,5	20004904	5.4	24.4	27.4	1150	720	1240	0.42	0.26	99	1.95
3 x 25 + 3 x 4	20016716	6.3	28.2	31.2	1630	1125	0.795	0.42	0.26	131	3.05
3 x 35 + 3 x 16/3	20004903	7.5	30.5	33.5	1950	1575	0.565	0.49	0.25	162	4.27
3 x 50 + 3 x 25/3	20004902	8.9	36	39	2750	2250	0.393	0.51	0.25	202	6.1
3 x 70 + 3 x 35/3	20004901	10.6	41.2	44.2	3700	3150	0.277	0.59	0.24	250	8.54
3 x 95 + 3 x 50/3	20004900	12.1	45.7	48.7	4650	4275	0.21	0.6	0.24	301	11.59
3 x 120 + 3 x 70/3	20001453	14.1	48.7	52.7	5750	5400	0.164	0.69	0.23	352	14.64
3 x 150 + 3 x 70/3	20004899	16	55.7	59.7	7070	6750	0.132	0.7	0.23	404	18.3
3 x 185 + 3 x 95/3	20004905	17.8	60.4	64.4	8470	9200	0.108	0.71	0.23	461	22.57
3 x 240 + 3 x 120/3	20008903	20.2	68.2	72.2	10900	11500	0.0817	0.73	0.23	540	29.28

Underground Mining



CABLES ACCORDING TO BS 6708

Type acc. to BS 6708	Usage and application
Type 7-7M-7S-11	1,1kV flexible rubber cable for use in underground mines
Type 307-307M-307S	3,3kV flexible rubber cable for use in underground mines
Type 201-211	1,1kV pliable wire armoured cables for underground use
Type 62-63-64	1,1kV pliable wire armoured for use as roadway extension and lighting cables
Type 321-331-631	MV pliable wired armoured for use as mine roadway extension cables
Type 506-512-518-524	Pliable wire armoured signaling and auxiliary cables

PROTOMONT Type 7, Type 7M, Type 7S, Type 11

Flexible trailing cables according to BS 6708



Application

The cables are suitable for fixed installation and flexible operation as power supply cables to motors, distribution boards, etc., in underground mining applications. The cables are used with coalcutters in cable chains (cable handlers) and similar face equipment.

Global data

Brand	PROTOMONT
Type	Type 7, Type 7M, Type 7S, Type 11
Standard	British Standard 6708
Certifications / Approvals	MA - China (special design) MSHA_ P-07-KA130007-MSHA

Design features

Conductor	Finely-stranded copper conductor, tinned, (class 5) acc. BS 6360
Insulation	PROTOLON, Basic material: EPR, colored acc. BS 7655
Core identification	Three power cores, Colors: Red, Yellow, Brown; Pilot core: Blue
Core arrangement	Layed up around the center earth core
Arrangement of PE-conductor	Bare, tinned copper conductor in the center of the cable; Type 11: copper/nylon braid
Monitoring conductor	Layed up together with the power cores
Screen	Phase core screen: Composite copper/nylon braid
Outer sheath	PROTOFIRM, Basic material: CR, Color: Black

Electrical parameters

Rated voltage	640/1100 V
Maximum permissible operating voltage AC	0.7/1.2 kV
Maximum permissible operating voltage DC	0.9/1.8 kV
AC test voltage	3 kV

Chemical parameters

Resistance to fire	EN 60332-1-2, IEC 60332-1-2
Resistance to oil	EN 60811-404, IEC 60811-404
Weather resistance	Unrestricted use outdoors and indoors, resistant to ozone and moisture

Thermal parameters

Max. permissible temperature at conductor	90 °C
Max. short circuit temperature of the conductor	250 °C
Ambient temperature for fix installation min.	-40 °C
Ambient temperature for fix installation max.	80 °C
Ambient temp. in fully flex. operation min.	-25 °C
Ambient temp. in fully flex. operation max.	60 °C

Mechanical parameters

Max. tensile load of cable	15 N/mm ²
Bending radii min.	Acc. to DIN VDE 0298 part 3

Number of cores x cross section	Part number	Conductor diameter max. mm	Outer diameter min. mm	Outer diameter max. mm	Net weight approx. kg/km	Permissible tensile force max. N	Conductor resistance at 20°C max. Ω/km	Nom. operating capacitance μF/km	Inductance nom. mH/km	Current carrying capacity (1) A	Short Circuit Current (conductor) kA
Typ 7											
3 x 16 + 1 x 16 + 1 x 16		5.2	35.8	38.6	2380	720	1.24	0.51	0.35	99	2.29
3 x 25 + 1 x 16 + 1 x 16		6.4	39.7	42.9	2880	1125	0.795	0.53	0.34	131	3.58
3 x 35 + 1 x 18 + 1 x 16		8	43.1	46.3	3587	1575	0.565	0.58	0.32	162	5.01
3 x 50 + 1 x 25 + 1 x 25		9.5	48.5	51.8	4640	2250	0.393	0.62	0.31	202	7.15
3 x 70 + 1 x 35 + 1 x 35		11.3	55.1	58.8	6000	3150	0.277	0.71	0.3	250	10.01
3 x 95 + 1 x 50 + 1 x 50		12.7	62.4	66.1	7650	4275	0.21	0.76	0.3	301	13.59
3 x 120 + 1 x 50 + 1 x 70		14.7	68	72.5	9350	5400	0.164	0.85	0.29	352	17.16
3 x 150 + 1 x 70 + 1 x 95		16.6	68.5	74	10900	6750	0.132	0.85	0.26	404	21.45
Typ 7M											
3 x 16 + 1 x 16 + 1 x 16		5.2	35.8	38.6	2440	720	1.24	0.51	0.35	99	2.29
3 x 25 + 1 x 16 + 1 x 25		6.4	39.7	42.9	3050	1125	0.795	0.53	0.34	131	3.58
3 x 35 + 1 x 18 + 1 x 35		8	43.1	46.3	3860	1575	0.565	0.58	0.32	162	5.01
3 x 50 + 1 x 25 + 1 x 50		9.5	48.5	51.8	4950	2250	0.393	0.62	0.31	202	7.15
3 x 70 + 1 x 35 + 1 x 70		11.3	55.1	58.8	6200	3150	0.277	0.71	0.3	250	10.01
3 x 95 + 1 x 50 + 1 x 95		12.7	62.4	66.1	8150	4275	0.21	0.76	0.3	301	13.59
3 x 120 + 1 x 50 + 1 x 120		14.7	68	72.5	9800	5400	0.164	0.85	0.29	352	17.16
3 x 150 + 1 x 70 + 1 x 150		16.6	68.5	74	11450	6750	0.132	0.85	0.26	404	21.45
Typ 7S											
3 x 25 + 1 x 16 + 3 x 2,5	20087232	6.4	39.9	42.9	2823	1125	0.795	0.48	0.33	131	3.58
3 x 35 + 1 x 18 + 3 x 4	20087231	8	43.3	46.3	3588	1575	0.565	0.55	0.32	162	5.01
3 x 50 + 1 x 25 + 3 x 4		9.5	48.5	51.8	4340	2250	0.393	0.62	0.31	202	7.15
3 x 70 + 1 x 35 + 3 x 6		11.3	55.1	58.8	5900	3150	0.277	0.71	0.3	250	10.01
3 x 95 + 1 x 50 + 3 x 6		12.7	62.4	66.1	7380	4275	0.21	0.76	0.3	301	13.59
3 x 120 + 1 x 50 + 3 x 10		14.7	68	72.5	8810	5400	0.164	0.85	0.29	352	17.16
3 x 150 + 1 x 70 + 3 x 10		16.6	68.5	74	10000	6750	0.132	0.85	0.26	404	21.45
Typ 11											
3 x 16 + 1 x 16		5.2	30.9	33	1920	720	1.24	0.51	0.35	99	1.95

PROTOMONT Type 307, Type 307M, Type 307S

Flexible trailing cables according to BS 6708



Application

The cables are suitable for fixed installation and flexible operation as power supply cables to motors, distribution boards, etc., in underground mining applications. The cables are used with coalcutters in cable chains (cable handlers) and similar face equipment.

Global data

Brand	PROTOMONT
Type designation	Type 307M
Type designation	Type 307S
Type designation	Type 307
Standard	British Standard 6708
Certifications / Approvals	MA - China (special design) MSHA: P-07-KA130007-MSHA

Design features

Conductor	Finely-stranded copper conductors, tinned (class 5) according to BS 6360
Insulation	PROTOLON, Basic material: EPR, Colored, according to BS 7655
Core identification	Three power cores colored: Red, Yellow, Brown, Pilot core: Blue Phase core screen: Composite copper/nylon braid
Core arrangement	Layed up around the centre earth core
Arrangement of PE-conductor	Bare, tinned copper conductor in the center of the cable
Pilot conductor	Layed up together with the power cores
Outer sheath	PROTOFIRM, Basic material: CR, Color: Red

Electrical parameters

Rated voltage	1,9/3,3 kV
Maximum permissible operating voltage AC	2.1/3.6 kV
Maximum permissible operating voltage DC	2.7/5.4 kV
AC test voltage	6 kV

Chemical parameters

Resistance to fire	EN 60322-1-2, IEC 60322-1-2
Resistance to oil	EN 60811-404, IEC 60811-404
Weather resistance	Unrestricted use outdoors and indoors, resistant to ozone and moisture

Thermal parameters

Max. permissible temperature at conductor	90 °C
Max. short circuit temperature of the conductor	250 °C
Ambient temperature for fix installation min.	-40 °C
Ambient temperature for fix installation max.	80 °C
Ambient temp. in fully flex. operation min.	-25 °C
Ambient temp. in fully flex. operation max.	60 °C

Mechanical parameters

Tensile load on the conductor max .	15 N/mm ²
Bending radii min.	Acc. to DIN VDE 0298 part 3

Number of cores x cross section	Part number	Conductor diameter max. mm	Outer diameter min. mm	Outer diameter max. mm	Net weight approx. kg/km	Permissible tensile force max. N	Conductor resistance at 20°C max. Ω/km	Nom. operating capacitance μF/km	Inductance nom. mH/km	Current carrying capacity (1) A	Short Circuit Current (conductor) kA
PROTOMONT Type 307											
3x25 + 1x25 + 1x16		6.8	47.4	49.9	3400	1125	0.795	0.41	0.4	131	3.58
3x35 + 1x25 + 1x16		8	51.6	54.6	4600	1575	0.565	0.47	0.37	162	5.01
3x50 + 1x35 + 1x25		9.5	56.8	59.8	6000	2250	0.393	0.54	0.36	202	7.15
3x70 + 1x50 + 1x35		11.3	62.8	65.8	7350	3150	0.277	0.61	0.34	250	10.01
3x95 + 1x50 + 1x50		12.7	68.9	72.7	9000	4275	0.21	0.66	0.33	301	13.59
3x120 + 1x70 + 1x70		14.7	73.4	77.2	10700	5400	0.164	0.72	0.32	352	17.16
PROTOMONT Type 307M											
3x25 + 1x25 + 1x25		6.8	47.4	49.9	3450	1125	0.795	0.41	0.4	131	3.58
3x35 + 1x25 + 1x35	20007533	8	51.6	54.6	4770	1575	0.565	0.47	0.37	162	5.01
3x50 + 1x35 + 1x50	20060874	9.5	56.8	59.8	6270	2250	0.393	0.54	0.36	202	7.15
3x70 + 1x50 + 1x70	20005156	11.3	62.8	65.8	7630	3150	0.277	0.61	0.34	250	10.01
3x95 + 1x50 + 1x95	20005157	12.7	68.9	72.7	9350	4275	0.21	0.66	0.33	301	13.59
3x120 + 1x70 + 1x120		14.7	73.4	77.2	11100	5400	0.164	0.72	0.32	352	17.16
PROTOMONT Type 307S											
3x50 + 1x35 + 3x4	20070946	9.5	56.8	59.8	5920	2250	0.393	0.54	0.36	202	7.15
3x70 + 1x50 + 3x6	20005158	11.3	62.8	65.8	7250	3150	0.277	0.61	0.34	250	10.01
3x95 + 1x50 + 3x6		12.7	68.9	72.7	8800	4275	0.21	0.66	0.33	301	13.59
3x120 + 1x70 + 3x10	20005159	14.7	73.4	77.2	10500	5400	0.164	0.72	0.32	352	17.16
3x150 + 1x95 + 3x10	20005160	16.6	73.3	77.3	11200	6750	0.132	0.77	0.31	404	21.45
3x185 + 1x95 + 3x10	20099768	18.2	75.4	80.4	12300	8325	0.108	0.81	0.3	461	26.46
3x240 + 1x95 + 3x10		21.7	82.2	87.2	15000	10800	0.0817	0.65	0.3	535	34.3

PROTOMONT Type 201, Type 211

Flexible trailing cables with galvanized steel pliable wire armouring



Application

The cables are suitable for fixed installation in underground mines for use as mine roadway extension cables and for coalface lighting.

Global data

Brand	PROTOMONT
Type	Type 211, Type 201
Standard	British Standard 6708

Design features

Conductor	Finely-stranded copper conductor, tinned, (class 5) acc. BS 6360
Insulation	PROTOLON, Basic material: EPR, colored according to BS 7655
Core identification	Power cores: Colored, Color code: Red, Yellow, Brown, Blue; Protective Earth conductor: Green/Yellow;
Core arrangement	Three power cores and the protective earth conductor layed up
Arrangement of PE-conductor	Layed up together with the power cores around a center filler
Inner sheath	Basic material: CR, Color: Black up to 1,1kV, Red > 1,1kV
Screen	Phase core screen: Composite copper/nylon braid
Reinforcement	Pliable armour of galvanized steel wires
Outer sheath	PROTOFIRM, Basic material: CR, Color: Black up to 1,1kV, Red > 1,1kV

Electrical parameters

Rated voltage	640/1100 V
Maximum permissible operating voltage AC	0.7/1.2 kV
Maximum permissible operating voltage DC	0.9/1.8 kV
AC test voltage	11 kV
AC test voltage	6 kV
AC test voltage	3 kV

Chemical parameters

Resistance to fire	IEC 60332-1-2
Resistance to oil	Given in accordance with EN 60811-404
Weather resistance	Unrestricted use outdoors and indoors, resistant to ozone and moisture

Thermal parameters

Max. permissible temperature at conductor	90 °C
Max. short circuit temperature of the conductor	250 °C
Ambient temperature for fix installation min.	-40 °C
Ambient temperature for fix installation max.	80 °C
Ambient temp. in fully flex. operation min.	-25 °C
Ambient temp. in fully flex. operation max.	60 °C

Mechanical parameters

Max. tensile load of cable	15 N/mm ²
Bending radii min.	Acc. to DIN VDE 0298 part 3

Number of cores x cross section	Conductor diameter max. mm	Outer diameter min. mm	Outer diameter max. mm	Net weight approx. kg/km	Permissible tensile force max. N	Conductor resistance at 20°C max. Ω/km	Nom. operating capacitance μF/km	Inductance nom. mH/km	Current carrying capacity (1) A	Short Circuit Current (conductor) kA
Type 201										
3 x 10	4	37.3	39.8	2900	450	1.95	0.48	0.39	74	1.43
3 x 16	5.2	40.6	43.4	3400	720	1.24	0.51	0.35	99	2.29
3 x 25	6.4	44.6	47.4	4100	1125	0.795	0.53	0.34	131	3.58
3 x 35	8	48.3	51.1	4800	1575	0.565	0.58	0.33	162	5.01
3 x 50	9.5	53.6	57.4	5900	2250	0.393	0.62	0.32	202	7.15
3 x 70	11.3	60.7	64.5	7700	3150	0.277	0.71	0.31	250	10.01
3 x 95	12.7	71.8	75.8	10900	4275	0.21	0.76	0.31	301	13.59
3 x 120	14.7	76.7	81	12500	5400	0.164	0.85	0.3	352	17.16
Type 211										
3 x 10 + 1 x 10	4.2	37.3	39.8	2500	450	1.95	0.48	0.39	74	1.43
3 x 16 + 1 x 16	5.2	40.6	43.4	3100	720	1.24	0.51	0.35	99	2.29
3 x 25 + 1 x 16	6.4	44.6	47.4	4000	1125	0.795	0.53	0.34	131	3.58
3 x 35 + 1 x 25	8	52.7	56.5	5600	1575	0.565	0.58	0.33	162	5.01
3 x 50 + 1 x 35	9.5	59.7	63.5	7300	2250	0.393	0.62	0.32	202	7.15
3 x 70 + 1 x 50	11.3	68.8	72.8	9500	3150	0.277	0.71	0.31	250	10.01
3 x 95 + 1 x 70	12.7	80.6	84.9	13300	4275	0.21	0.76	0.31	301	13.59
3 x 120 + 1 x 70	14.7	86.2	90.5	15200	5400	0.21	0.85	0.3	352	17.16

PROTOMONT Type 62, Type 63, Type 64

Flexible trailing cables with galvanized steel pliable wire armouring



Application

The cables are suitable for fixed installation in underground mines for use as mine roadway extension cables and for coalface lighting.

Global data

Brand	PROTOMONT
Type	Type 62, 63, 64
Standard	British Standard 6708

Design features

Conductor	Finely-stranded copper conductor, tinned, (class 5) acc. BS 6360
Insulation	PROTOLON, Basic material: EPR, colored according to BS 7655
Core identification	Power cores: Colored, Color code: Red, Yellow, Brown, Earth conductor: Green/Yellow; Type 62: Brown, Blue; Type 63: Red, Brown, Blue; Type 64: Red, Yellow, Brown, Blue
Core arrangement	Three power cores and the protective earth conductor layed up
Arrangement of PE-conductor	Layed up together with the power cores around a center filler
Inner sheath	Basic material: CR, Color: Black
Screen	Phase core screen: Composite copper/nylon braid
Reinforcement	Pliable armour of galvanized steel wires
Outer sheath	PROTOFIRM, Basic material: CR, Color: Black

Electrical parameters

Rated voltage	640/1100 V
Maximum permissible operating voltage AC	0.7/1.2 kV
Maximum permissible operating voltage DC	0.9/1.8 kV
AC test voltage	3 kV

Chemical parameters

Resistance to fire	IEC 60332-1-2
Resistance to oil	Given in accordance with EN 60811-404
Weather resistance	Unrestricted use outdoors and indoors, resistant to ozone and moisture

Thermal parameters

Max. permissible temperature at conductor	90 °C
Max. short circuit temperature of the conductor	250 °C
Ambient temperature for fix installation min.	-40 °C
Ambient temperature for fix installation max.	80 °C
Ambient temp. in fully flex. operation min.	-25 °C
Ambient temp. in fully flex. operation max.	60 °C

Mechanical parameters

Max. tensile load of cable	15 N/mm ²
Bending radii min.	Acc. to DIN VDE 0298 part 3

Number of cores x cross section	Conductor diameter max. mm	Outer diameter min. mm	Outer diameter max. mm	Net weight approx. kg/km	Permissible tensile force max. N	Conductor resistance at 20°C max. Ω/km	Nom. operating capacitance μF/km	Inductance nom. mH/km	Current carrying capacity (1) A	Short Circuit Current (conductor) kA
Type 62, 63, 64										
2 x 4	2.4	23.9	26.4	1500	120	5.09	0.36	0.38	41	0.58
3 x 4	2.4	24.8	27.3	1300	180	5.09	0.36	0.38	41	0.58
4 x 4	2.4	26.4	28.9	1200	240	5.09	0.36	0.38	41	0.58

PROTOMONT Type 321, Type 331

Flexible trailing cables with galvanized steel pliable wire armouring



Application

The cables are suitable for fixed installation in underground mines for use as mine roadway extension cables and for coalface lighting.

Global data

Brand	PROTOMONT
Type	Type 321, 331
Standard	British Standard 6708

Design features

Conductor	Finely-stranded copper conductor, tinned, (class 5) acc. BS 6360
Insulation	PROTOLON, Basic material: EPR, colored according to BS 7655
Core identification	Power cores: Colored, Color code: Red, Yellow, Brown, Earth conductor: Green/Yellow
Core arrangement	Three power cores and the protective earth conductor layed up
Arrangement of PE-conductor	Layed up together with the power cores around a center filler
Inner sheath	Basic material: CR, Color: Red
Screen	Phase core screen: Composite copper/nylon braid
Reinforcement	Pliable armour of galvanized steel wires
Outer sheath	PROTOFIRM, Basic material: CR, Color: Red

Electrical parameters

Rated voltage	1.9/3.3 kV
Maximum permissible operating voltage AC	2.1/3.6 kV
Maximum permissible operating voltage DC	2.7/5.4 kV
AC test voltage	6 kV

Chemical parameters

Resistance to fire	EN 60332-1-2, IEC 60332-1-2
Resistance to oil	EN 60811-404, IEC 60811-404
Weather resistance	Unrestricted use outdoors and indoors, resistant to ozone and moisture

Thermal parameters

Max. permissible temperature at conductor	90 °C
Max. short circuit temperature of the conductor	250 °C
Ambient temperature for fix installation min.	-40 °C
Ambient temperature for fix installation max.	80 °C
Ambient temp. in fully flex. operation min.	-25 °C
Ambient temp. in fully flex. operation max.	60 °C

Mechanical parameters

Max. tensile load of cable	15 N/mm ²
Bending radii min.	Acc. to DIN VDE 0298 part 3

Number of cores x cross section	Conductor diameter max. mm	Outer diameter min. mm	Outer diameter max. mm	Net weight approx. kg/km	Permissible tensile force max. N	Conductor resistance at 20°C max. Ω/km	Nom. operating capacitance μF/km	Inductance nom. mH/km	Current carrying capacity (1) A	Short Circuit Current (conductor) kA
Type 331										
3 x 25 + 1 x 16	6.4	57.8	61.6	6400	1125	0.795	0.41	0.4	131	3.58
3 x 35 + 1 x 25	8	64.6	68.4	7800	1575	0.565	0.47	0.37	162	5.01
3 x 50 + 1 x 35	9.5	69.8	73.8	9100	2250	0.393	0.54	0.36	202	7.15
3 x 70 + 1 x 50	11.3	80.3	84.6	12400	3150	0.277	0.61	0.34	250	10.01
3 x 95 + 1 x 70	12.7	86.4	90.7	14600	4275	0.21	0.66	0.33	301	13.59
3 x 120 + 1 x 70	14.7	90.9	95.2	16760	5400	0.164	0.72	0.32	352	17.16
3 x 150 + 1 x 70	16.6	90.9	95.2	17155	6750	0.132	0.77	0.31	404	21.45
Type 321										
4 x 35	8	56.2	60	6210	2100	0.565	0.47	0.37	162	5.01
4 x 50	9.5	63.9	67.7	7800	3000	0.393	0.54	0.36	202	7.15
4 x 70	11.3	70	74	9410	4200	0.277	0.61	0.34	250	10.01
4 x 95	12.7	80.6	84.9	11800	5700	0.21	0.66	0.33	301	13.59
4 x 120	14.7	85	89.3	13600	7200	0.164	0.72	0.32	352	17.16

PROTOMONT Type 631

Flexible trailing cables with galvanized steel pliable wire armouring



Application

The cables are suitable for fixed installation in underground mines for use as mine roadway extension cables etc.

Global data

Brand	PROTOMONT
Type	Type 631
Standard	British Standard 6708

Design features

Conductor	Finely-stranded copper conductor, tinned, (class 5) acc. BS 6360
Insulation	PROTOLON, Basic material: EPR, colored according to BS 7655
Core identification	Power cores: Colored, Color code: Red, Yellow, Brown, Earth conductor: Green/Yellow
Core arrangement	Three power cores and the protective earth conductor layed up
Arrangement of PE-conductor	Layed up together with the power cores around a center filler
Inner sheath	Basic material: CR, Color: Red
Screen	Phase core screen: Composite copper/nylon braid
Reinforcement	Pliable armour of galvanized steel wires
Outer sheath	PROTOFIRM, Basic material: CR, Color: Red

Electrical parameters

Rated voltage	3.8/6.6kV
Maximum permissible operating voltage AC	4.2/7.2 kV
Maximum permissible operating voltage DC	5.4/10.8 kV
AC test voltage	11 kV

Chemical parameters

Resistance to fire	EN 60332-1-2, IEC 60332-1-2
Resistance to oil	EN 60811-404, IEC 60811-404
Weather resistance	Unrestricted use outdoors and indoors, resistant to ozone and moisture

Thermal parameters

Max. permissible temperature at conductor	90 °C
Max. short circuit temperature of the conductor	250 °C
Ambient temperature for fix installation min.	-40 °C
Ambient temperature for fix installation max.	80 °C
Ambient temp. in fully flex. operation min.	-25 °C
Ambient temp. in fully flex. operation max.	60 °C

Mechanical parameters

Max. tensile load of cable	15 N/mm ²
Bending radii min.	Acc. to DIN VDE 0298 part 3

Number of cores x cross section	Conductor diameter max. mm	Outer diameter min. mm	Outer diameter max. mm	Net weight approx. kg/km	Permissible tensile force max. N	Conductor resistance at 20°C max. Ω/km	Nom. operating capacitance μF/km	Inductance nom. mH/km	Current carrying capacity (1) A	Short Circuit Current (conductor) kA
Type 631										
3 x 50 + 1 x 35	9.5	86.7	91	13400	2250	0.393	0.43	0.42	202	7.15
3 x 70 + 1 x 50	11.3	92.8	97.1	15570	3150	0.277	0.49	0.4	250	10.01
3 x 95 + 1 x 70	12.7	93.9	98.6	16700	4275	0.21	0.54	0.38	301	13.59
3 x 120 + 1 x 70	14.7	95.1	100.1	17860	5400	0.164	0.6	0.37	352	17.16

PROTOMONT Type 506, Type 512, Type 518, Type 524

Auxiliary cables with galvanized steel pliable wire armouring



Application

The cables are suitable for fixed installation in underground mines to provide remote control circuits and for interconnections between sections of mining machines or between machine sections and associated auxiliary equipment.

Global data

Brand	PROTOMONT
Type	Type 506, 512, 518, 524
Standard	British Standard 6708

Design features

Conductor	Finely-stranded copper conductors, tinned (class 5) according to BS 6360
Insulation	Basic material: ETFE, Colored according to BS 7655
Core identification	Colored insulation
Core arrangement	6, 12, 18 or 24 cores laid up around a rubber filler
Inner sheath	Basic material: CR, Color: Black
Screen	Core screen: Individual copper/textile braid
Reinforcement	Flexible armor of galvanized steel wires
Outer sheath	PROTOFIRM, Basic material: CR, Color: Black

Electrical parameters

Rated voltage	320/550 V
Maximum permissible operating voltage AC	0,45/0,60 kV
Maximum permissible operating voltage DC	0,35/0,60 kV
AC test voltage	2 kV

Chemical parameters

Resistance to fire	EN 60322-1-2, IEC 60322-1-2
Resistance to oil	EN 60811-404, IEC 60811-404
Weather resistance	Unrestricted use outdoors and indoors, resistant to ozone and moisture

Thermal parameters

Max. permissible temperature at conductor	90 °C
Max. short circuit temperature of the conductor	250 °C
Ambient temperature for fix installation min.	-40 °C
Ambient temperature for fix installation max.	80 °C
Ambient temp. in fully flex. operation min.	-25 °C
Ambient temp. in fully flex. operation max.	60 °C

Mechanical parameters

Max. tensile load of cable	15 N/mm ²
Bending radii min.	Acc. to DIN VDE 0298 part 3

Number of cores x cross section	Conductor diameter max. mm	Outer diameter min. mm	Outer diameter max. mm	Net weight approx. kg/km	Permissible tensile force max. N	Conductor resistance at 20°C max. Ω/km	Nom. operating capacitance μF/km	Inductance nom. mH/km	Current carrying capacity (1) A	Short Circuit Current (conductor) kA
6 x 1,34	1.5	21.1	23.6	900	48	15.4	0.5	0.31	16	0.18
12 x 1,34	1.5	21.1	23.6	980	96	15.4	0.5	0.31	13	0.18
18 x 1,34	1.5	22.8	25.3	1150	144	15.4	0.5	0.31	11	0.18
24 x 0,93	1.3	24.2	26.7	1250	134	22.1	0.34	0.28	8	0.12

Mining cables



Trademarks used for flexible electric cables for mining applications

Flexible cables

CORDAFLEX®	LHD cable for scoop operations 1 kV tough rubber-sheathed reeling cable
OPTOFLEX®	Rubber-sheathed flexible fibre-optic cable
PROTOLON®	Medium-voltage reeling cable, trailing cables, medium-voltage flexible cables
PROTOMONT®	Heavy tough rubber-sheathed flexible cables
SUPROMONT®	Medium-voltage mining-type cables for fixed installation
TENAX®	Low- and medium-voltage flexible cables for underground and opencast application
FELTOFLEX®	Medium-voltage flexible single core cables

Special compounds

PROTODUR®	Insulating compound PVC used in SUPROMONT® cables
PROTOFIRM®	Sheathing compound PCP used in CORADFLEX®, PROTOLON®, PROTOMONT®, compound with special resistance to abrasion and tearing, 5GM5 quality
PROTOLON®	Insulating compound EPR used in CORADFLEX®, PROTOLON®, PROTOMONT®. Rubber compound with excellent electrical properties, resistant to heat and weather

Mining cables

Type / Type designation

The type designates a group of flexible cables which have the same design features and which are intended for a specific range of technical applications.

The type designation is a letter combination in conformity with DIN VDE, which describes the type in coded form¹⁾. For details of the application please refer to the application guidelines.

NSHTÖU	LHD cables for scoop operations: Tough rubber-sheathed 1 kV flexible reeling cable CORDAFLEX (S), TENAX LK, PROTOMONT (S)
R-(N)TSCGEWÖEU	Medium-voltage reeling cable, 6 to 30 kV PROTOLON (M)
F-(N)TSCGEWÖEU	Medium-voltage flexible cable, 6 to 30 kV PROTOLON (M)
NTSCGEWÖEU	Trailing cables PROTOLON and TENAX, 3 to 35 kV
(N)SHÖEU	Heavy tough rubber-sheathed flexible cable, 1 kV, for applications in open-cast mining, PROTOMONT (M)
NSSHÖEU	Heavy tough rubber-sheathed flexible cable, 1 kV, for applications in underground mining, PROTOMONT
NSSHCGEÖEU	Coal cutter cables for underground mining applications PROTOMONT(Z), PROTOMONT(V) and TENAX CTE
NTMCGCWOEU/ NTMCWÖU	Trailing cables of single-sheath design for medium mechanical stresses
(N)3GHSSYCY	EPR-insulated medium-voltage cables for fixed installation, SUPROMONT
2YSLGCGÖEU	Data, signal and control cable for mining installations PROTOMONT MSR Mining
L-2YY(Z)Y-KF40	PVC-sheathed flexible copper data cable

The type designation can be deciphered as follows:

..C..	Conducting metal casing over the stranded cores or between the inner and outer sheath (shield)
(C)	Additional information about the shield for the conductor cross-sections, e.g. 12 x 1 (C) which means 1 mm ² individually shielded or 6 x (2 x 1)C which means 2 x 1 mm ² twisted and shielded pairs
..CE..	Conducting metal casing over the insulation of the outer conductors
..CG..	Conducting non-metal casing over the stranded cores or between the inner and outer sheath (shield)
..CGE..	Conducting non-metal casing over the insulation of the outer conductors
F-	Definition of the application: Fixed installation, as supplement to the type designation
FM	Telecommunication lines within the cable

¹⁾ The German characters „Ö“ and „Ü“ are transformed into the international „OE“ and „UE“, respectively

G	High-voltage (HV)
-J	Additional information about the type: With green/yellow marked core
...K...	Rubber cradle separator in the centre of the cables
KON	Concentric protective conductor between the inner and outer sheath or concentric control/monitoring conductor
L...	Lightweight cable design
LWL	Fibre-optic (FO)
(M)	Appendix to trademark, „M = Mining“
N	Design according to the corresponding standard
(N)	Based on standard
-O	Additional information about the type - without green/yellow marked core
Ö¹⁾	Oil-resistant outer sheath (according to DIN VDE 0473, Part -2-1, Para. 10) (OE)
R-	Definition of application: Reeling, as appendix to the type designation
(SB)	Appendix to trademark: Trailing operation
..SH..	Heavy tough rubber-sheathed flexible mining-type cable (Rough handling)
...SHT...	1 kV reeling cable
..SL..	Control cable
ST	Control cores within the cables
(ST)	Appendix to trademark to denote water compatibility (submersible pump units)
..T..	Support element
..TM..	Trailing cable for medium mechanical stresses
..TS..	Trailing cables
U	Flame-retardant outer sheath (according to EN 60332-1-2)
ÜL¹⁾	Monitoring conductor within the cable (UEL)
(V)	Appendix to trademark for coal cutter cables (V = reinforced)
..W..	Weather resistant
Y	PVC compound
(Z)	Appendix to trademark for coal cutter cables (Z=tensile strength optimized)
2Y...	Definition of the insulation material (2Y = PE)
/3	Protective-earth conductor uniformly distributed in the three interstices
/3E	Protective-earth conductor uniformly distributed over the insulation of the outer conductor
..3G..	Definition of the insulating material (3G = EPR)

Approvals / Standards

Flexible electric cables for mining applications have to be able to cope with the expected operation and installation conditions. Details are given in the application and installation guidelines. In addition, flexible electric cables for mining applications are described with regard to designs and tests as laid down in national and international standards (design regulations).

Application and installation guidelines

DIN VDE 0298, Part 3	Application of cables and flexible cords in power installations - General information on cables
DIN VDE 0298, Part 4	Application of cables and flexible cords in power installations - Recommended values for current-carrying capacity of cables
DIN VDE 0101	Erection of power installations with rated voltages above 1 kV
DIN VDE 0118	Specification for the erection of electrical installations in underground mines
DIN VDE 0168	Specification for the erection of electrical installations in open-cast mines, quarries and similar works
IEC 621	Electrical installations for outdoor sites under heavy conditions (incl. open-cast mines and quarries)

Design regulations

The summary on page 179 shows all the design regulations/standards, according to which the electric cables for mining applications are designed and manufactured. The following distinctions are made between national and international regulations:

National standard

DIN VDE (DIN = German Standards Institute; VDE = Association of German Electrical Engineers)
Germany is one of a few countries which has issued special design regulations for flexible electric cables for mining applications. The 1 kV tough rubber-sheathed flexible reeling cables NSHTÖU, the trailing cables NTS.WÖU and the rubber-sheathed flexible cables NSSHÖU are described and standardized in DIN VDE 0250. This set of standards has found recognition in Europe and in many countries outside Europe and is accepted as or specified as „state of the art“.

No such design regulations exist for the MSR Mining and OPTOFLEX cables. These are Prysmian Group special cables, the design of which is based on existing design regulations or general regulations of DIN VDE.

International standard

For use on an international level, some design features of flexible electric cables for mining applications covered by DIN VDE are also listed or certified.

MSHA = Mine Safety and Health Administration, USA

MA China = Chinese mining approval

WUG = Approval of the Polish Mining Inspectorate, necessary for use of cables in Polish mines

TR-certificate = Safety regulation for LV-cables in Russia, Belarus, Kazakhstan

Fire certificate = Russian Mining approval

Gost B = Mining approval of Republic of Belarus for cables >1kV

Gost K = Mining approval of Kazakhstan for cables >1kV

Flexible cables	Type	German stand. DIN VDE	International stand.
FELTOFLEX	NTMCW0EU	DIN VDE 0250, Part 813	Fire certificate, Gost K, Gost B
PROTOLON	NTMCGCW0EU	DIN VDE 0250, Part 813	Fire certificate, Gost K, Gost B
PROTOLON (M-R)	(N)TSCGEW0EU	Based on DIN VDE 0250, Part 813	Fire certificate, Gost K, Gost B
CORDAFLEX (S)	NSHTÖU	DIN VDE 0250, Part 814	MSHA P 189-3, TR-certificate, Fire certificate, Gost K, Gost B
TENAX LK	NSSHUCGEOEU	DIN VDE 0250, Part 812	TR-certificate, Fire certificate, Gost K, Gost B
OPTOFLEX (M)		Based on DIN VDE 0888 and DIN VDE 0168	Based on FDDI, ISO/IEC 9314, MSHA SC 189-1
PROTOMONT (S)	NSSHC GEOEU	DIN VDE 0250, Part 812	MA China, TR-certificate, Fire certificate, Gost K, Gost B
PROTOLON (M)	(N)TSCGEWÖU	Based on DIN VDE 0250, Part 813	Gost K, Gost B
PROTOLON (SB-SAM)	NTSCGEWÖU	DIN VDE 0250, Part 813	Fire certificate, Gost K, Gost B
TENAX SAS	NTSCGEWÖU	DIN VDE 0250, Part 813	Fire certificate, Gost K, Gost B
PROTOLON (ST)	NTSCGEWÖU	DIN VDE 0250, Part 813	MSHA P 189-4, Fire certificate, Gost K, Gost B
PROTOMONT (M)	(N)SHÖU	Based on DIN VDE 0250, Part 812	TR-certificate, Fire certificate, Gost K, Gost B
PROTOMONT	NSSHÖU.../3E	DIN VDE 0250, Part 812	MSHA P 189-3, TR-certificate, MA China, Fire certificate, Gost K, Gost B
PROTOMONT (EMV-FC)	NSSHCOEU	DIN VDE 0250, Part 812	MSHA P 189-3, TR-certificate, MA China, Fire certificate, Gost K, Gost B
PROTOMONT MSR Mining	2YSLGCGÖU	Based on DIN VDE 0282, Part 4	Fire certificate
PROTOMONT (Z)	NSSHC GEÖU	DIN VDE 0250, Part 812	MSHA P 189-3, TR-certificate, Fire certificate, Gost K, Gost B
PROTOMONT (V)	NSSHC GEÖU	DIN VDE 0250, Part 812	MSHA P 189-3, TR-certificate, Fire certificate
PROTOMONT (V)	NTSKCGECWÖU	DIN VDE 0250, Part 813	MSHA P 189-4, MA China, WUG, TR-certificate, Fire certificate, Gost K, Gost B
TENAX CTE	NSSHKCGEOEU	DIN VDE 0250, Part 812	TR-certificate, Fire certificate, Gost K, Gost B
PROTOMONT TBM	(N)TSCGCW0EU	Based on DIN VDE 0250, Part 813	Fire certificate, Gost K, Gost B
TENAX HTT	NTSCGCW0EU	DIN VDE 0250, Part 813	Fire certificate, Gost K, Gost B

Mining cables

Colour coding of fibre-optics

	No. of fibres	Fibre colours	Buffering tube colours
Monomode design E9/125 µm	6 x 1E9/125	OG / BN / WH / RD / BK / YE	6 x nf
	6 x 2E9/125	OG-PK / BN-PK / WH-PK / RD-PK / BK-PK / YE-PK	6 x nf
	6 x 3E9/125	BU / OG / GN	YE / BK / nf / nf / nf / nf
Graded-index fibre design G50/125 µm	6 x 1G50/125	OG / GN / BN / WH / RD / BK	6 x nf
	6 x 2G50/125	OG-PK / GN-PK / BN-PK / WH-PK / RD-PK / BK-PK	6 x nf
	6 x 3G50/125	BU / OG / GN	GN / BK / nf / nf / nf / nf
Graded-index fibre design G62.5/125 µm	6 x 1G62.5/125	BU / OG / BN / WH / RD / BK	6 x nf
	6 x 2G62.5/125	BU-PK / OG-PK / BN-PK / WH-PK / RD-PK / BK-PK	6 x nf
	6 x 3G62.5/125	BU / OG / GN	BU / BK / nf / nf / nf / nf

Bold-faced colour codings are indices relative to the fibre type.

Abbreviations for colour coding of the fibre optics:

BK = black	CY = cyan	OG = orange	TK = turquoise	YE = yellow
BN = brown	GN = green	PK = pink	VI = violet	
BU = blue	nf = natural colouring	RD = red	WH = white	

Installation and handling of reeling cables

Winding from supply drum to the operation drum

- Supply drum in parallel position to the operation drum
- Min. 4m between 2 bendings
- Use operation guiding system to wind the cable on the operation drum
- No S-bendings
- No torsion
- Watch the max. tensile load during the rewinding process

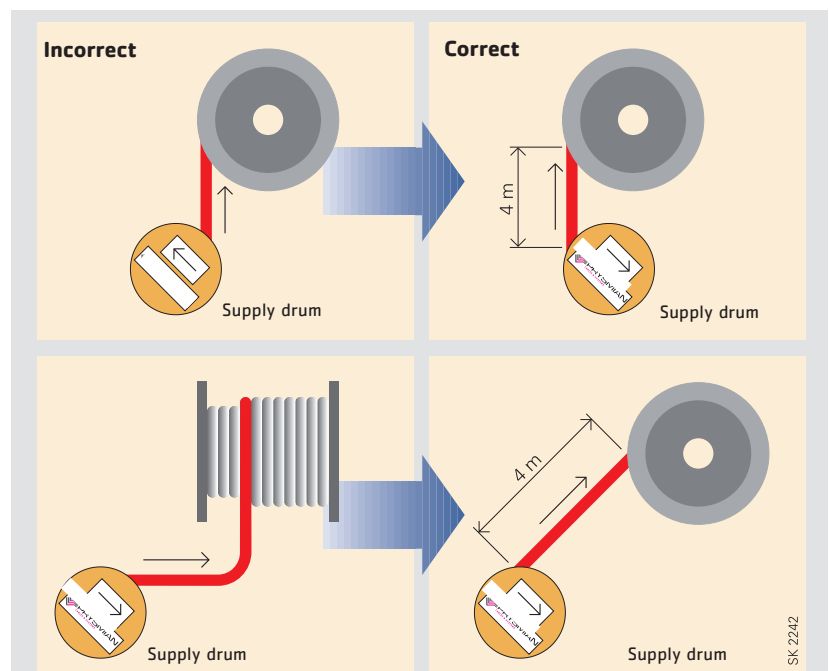

Never: draw the cable over the flange „head over heels“, because this would cause 360° torsion with each loop.

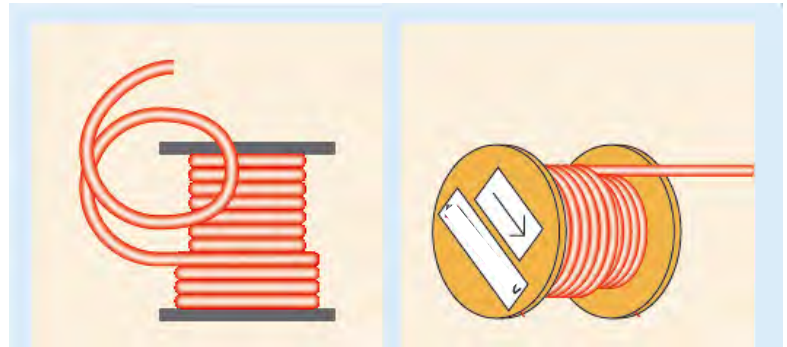

Incorrect

Correct

Start winding on cylindrical reels

Power cables: first loop (winding) at the left flange

Control cables: first loop (winding) at the right flange

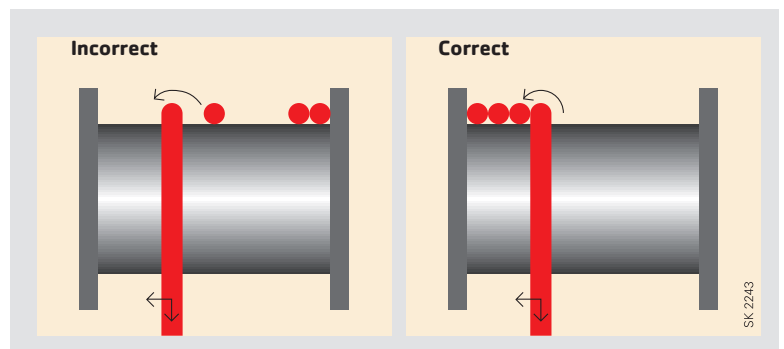

Incorrect

Correct

Mining cables

During operation

Tensile load: the max. tensile load is given in the corresponding cable data sheet.

Bending radii: See table below

Torsional stress: may be caused by transversal moving in the sheaves or by misaligned guiding systems.

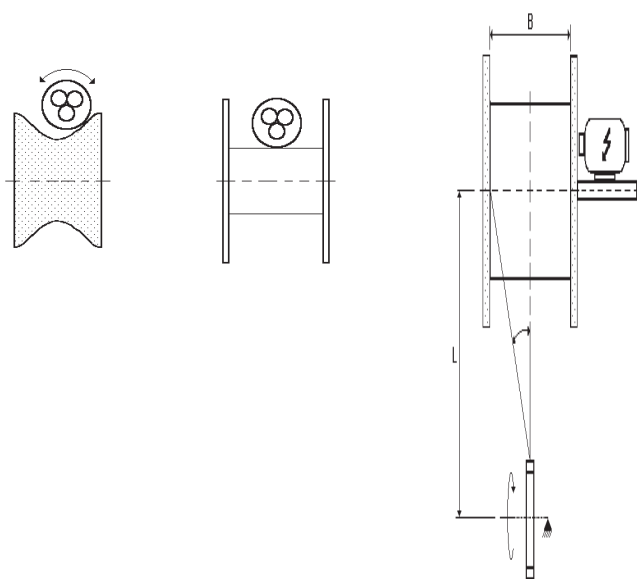

	Minimum permissible bending radii (for cable $D_L > 20\text{mm}$)
Fixed installation	$6 \times D_L$
Fully flexible operation	$10 \times D_L$
Entry e.g. at a centre feeding point	$10 \times D_L$
forced guidance with reeling operation	$12 \times D_L$
forced guidance with sheaves	$15 \times D_L$

D_L = cable diameter

Installation and handling of underground mining cables

Transportation to the underground face

- Either on the original supply drum or by using a transportation container
- By using a transport container the cable has to be inserted in „8-shapes“

Cable handling in the longwall face

- Pulling out of the transportation container and taking into the face only manually
- Don't undercut the minimum bending radius
- No torsion
- Don't kink the cable
- Watch the max. tensile load during the whole installation process

Never: Draw or drag the cable by using the face conveyor or hoist

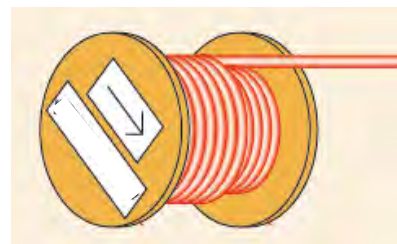

Integration of PROTOMONT (V); (VO) and TENAX CTE into the cable chain (cable handler)

- The cable should have high latitude (mobility) in the chain along the complete length
- The cable should lay uncongested in the chain: means no clamping along the length. 3mm to 5mm distance between cable and chain is required
- Don't use any cable straps to fix the cable at the chain
- The cable should have only one fixing point in the chain; directly behind the machine



Guidelines for a long lifetime of chain cables

- Tensile force monitoring or shear pin (bolt) should be used to protect the cable against exceeding tensile forces
- The spill plate should be cleaned periodically from coal and rocks in order to guarantee a free trailing of the cable and the cable handler (cable chain).
- Periodical control of the cable with respect to damages, squeezing and crushing
- Damages in the outer sheath should be repaired immediately by using a self-vulcanizing tape in order to avoid moisture penetration into the cable

Mining cables

Installation and handling of opencast trailing cables

Transportation on site

- Either on the original supply drum or by using a transportation container or on a truck platform
- By using a transport container or the truck platform the cable has to be inserted in „8-shapes“

Cable handling on site

- Pulling out of the transportation container and laying on the ground only manually
- Do not drag the cable over the flange when removing from the drum, because this would cause 360° torsion with each loop
- Do not undercut the minimum bending radius
- No torsion
- Do not kink the cable
- Watch the max. tensile load during the whole installation process

Never: Draw or drag the cable by using the excavator or hoist equipment.



During operation

- Use a cable strain relief to fix the cable at the top of the pole
- Use a pulling bow for moving the cable over the ground
- Do not exceed the maximum tensile forces during pulling the cable over ground

Guidelines for a long lifetime of trailing cables

- Periodical control of the cable with respect to damages, squeezing and crushing
- Damages in the outer sheath should be repaired immediately by using a self-vulcanizing tape in order to avoid moisture penetration into the cable
- Avoid high tensile forces to the cable
- Avoid kinking and twisting the cable



Laying instructions for OPTOFLEX (M) cables

OPTOFLEX (M) fiber-optic cables are designed for the severe operating conditions prevailing in mining applications.

However, maintenance of the desired transmission characteristics is also dependent on a number of factors, which must be taken into account for laying and installation.

Tensile load

The permissible tensile load of 2000 N may not be exceeded during laying. Special care must be taken, where the cable is supplied in long supply lengths and is pulled off axially from the supply drum. The thereby occurring acceleration forces of the drum must under no circumstances be transmitted through the cable.

Bending radius

Laying of the cable must be carried out in such a manner that the minimum bending radius of 50 mm is maintained under all circumstances. In particular, on entry into equipment and switchgear cubicles precautions must be taken to ensure that kinking of the cable does not occur.

Pinching stress

Attention must be paid to ensure that, when the cable is fastened by means of cable clips, cable binding bands, etc., the permissible transverse pressure forces are not exceeded. In the course of appropriate pinching stress tests a limit value of 300 N/cm was determined, up to which value no increase in attenuation was detected.

Torsional stress

On laying OPTOFLEX cables, care must be taken to ensure that impermissible torsional stresses are not applied to the cables. Under no circumstances may the cable be drawn from the ring or the drum „head over heels“, since otherwise a torsion through 360° would occur for each turn of the cable.

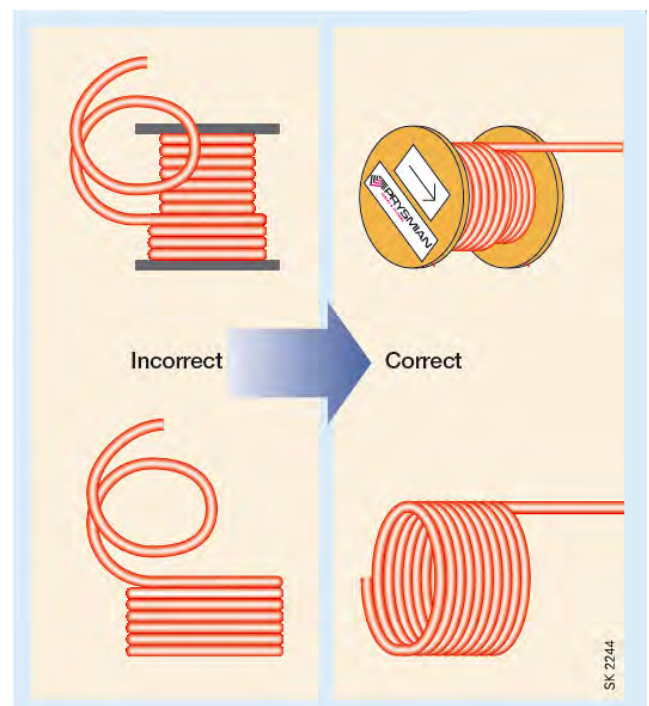

Mining cables

Centre feeding point

In many installations, e.g. bunkering equipment, the power infeed point is located at the centre of the guideway. The flexible electric reeling cables are normally connected through underfloor infeeds (see picture).

In order to achieve effective strain relief in conjunction with cable-wear minimizing deflection from the infeed point, we recommend the use of underfloor infeeds (see figure below). It is important that the specified bending radius is maintained and that the cable is fastened at the compensation cylinder by means of a clip, which, however, should be attached only after the 2nd winding.



- 1 Flexible electric reeling cable
- 2 Entry bell for infeed
- 3 Cable tray
- 4 Cable straight-through joint
- 5 Buried cable
- 6 Compensation cylinder
- 7 Cable clip (large area design)
- d Max. cable diameter
- R_{min} Bending radius of entry bell and bending radius of compensation cylinder

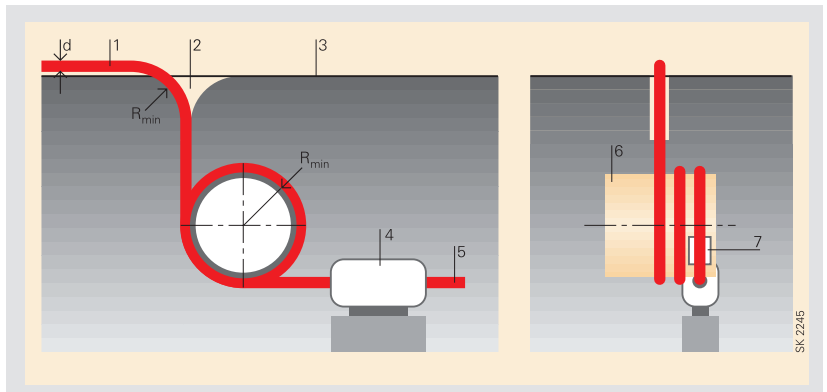

Min. permissible bending radius as a function of the cable diameter

Flexible cables	CORDAFLEX / TENAX				PROTOLON / TENAX
	Rated voltage U_0/U				Above 0.6/1kV
d in mm	Up to 8	Above 8 to 12	Above 12 to 20	Above 20	10 x d
R_{min}	3 x d	4 x d	5 x d	5 x d	

Determination of the sag on mast mounting

Both in open-cast mines and also in other industrial applications (e.g. construction sites) flexible cables must sometimes be suspended above guideways (see picture).

In such cases maintenance of the minimum permissible bending radius at the cable suspension point and of the max. permissible tensile force for each type of cable design must be observed.

For the correct cable installation, the following three diagrams are provided, which depict the sag as a function of the span.

In case of PROTOLON trailing cables for the main voltage levels of 3.6/6 kV, 6/10 kV and 8.7/15 kV, the sag should be taken from the diagram for the desired span. A max. permissible tensile load of 15 N/mm² has been incorporated as a parameter in the diagram.

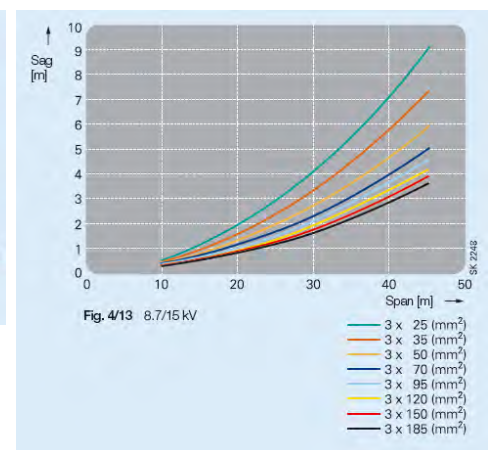
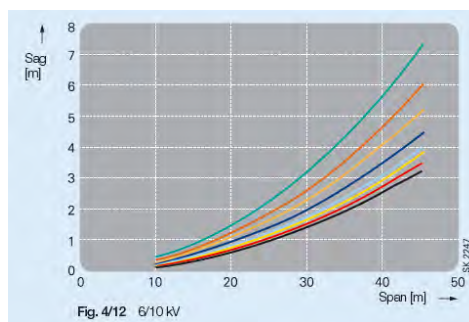
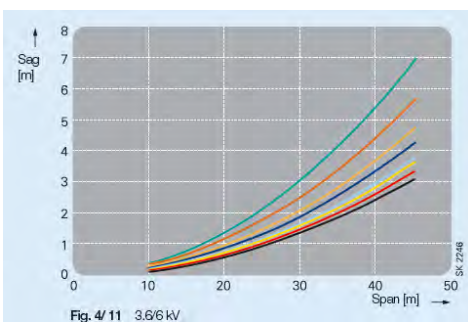

Mining cables

Electrical field control in hybrid sealing ends

In order to control the electrical field in medium-voltage cables, the use of an inner semiconductive layer is required, which is applied as a smoothing layer directly on the metallic conductor, the insulation covering and the outer semiconductive layer, which is in contact with the protective-earth conductor. In cable systems the sealing ends are assigned the task of containing the electrical field. Our hybrid sealing ends, which are specially designed for the operational requirements of flexible electric cables for mining applications, operate on the principle of resistive electrical field control, which achieves potential reduction as a result of the ohmic and capacitive characteristics and thus reduces the electrical field strength to an acceptable level over the length of the serving.

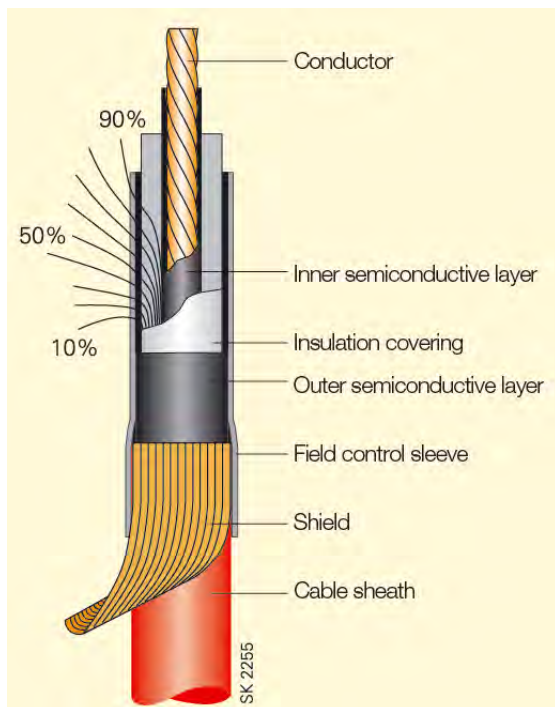

Stripping semiconductive layers

In the case of PROTOLON and TENAX with bright (light grey) core insulation, the semiconductive rubber layer over the insulation must be stripped carefully in order to mount the cable sealing end. To this end, the stripping point is marked and a circular indentation is made on the cable by slightly pressing a pipe cutter.



Make a notch at the stripping point by means of a triangular-section file while bending the cable slightly. It is important hereby that the bright core insulation should not be damaged.



Carefully cut through approx. 2/3 of the semiconductive rubber layer using between two to four longitudinal cuts. Warm the core end slightly using a propane gas flame and lift off the semiconductive layer at the end of the core using a wood rasp. Strip off the semiconductive layer in strips and remove it completely.



Remark

Problems can arise when stripping off the semiconductive layer due to tearing out of part of the insulation layer. In such case, the stripping procedure must be started from the opposite side. Use a smooth file, where necessary.

Stripping semiconductive cold-strippable layers (orange insulation color)

The distinguishing feature of these cables is the cold-strippable semiconductive layer. In this case heating by means of a propane gas flame can be omitted completely. The work sequence should otherwise be carried out as described above.

Mining cables

Sealing ends

Sealing ends form the termination point of a medium voltage cable and serve as a connection to the electrical equipment (e.g. switchgears etc.).

Sealing ends cover the following objectives:

- Connection of the conductor
- Sealing of the cable end against ambient influences (e.g. ingress of water)
- Controlled decrement of the electrical field strength
- Insulation from earthed parts

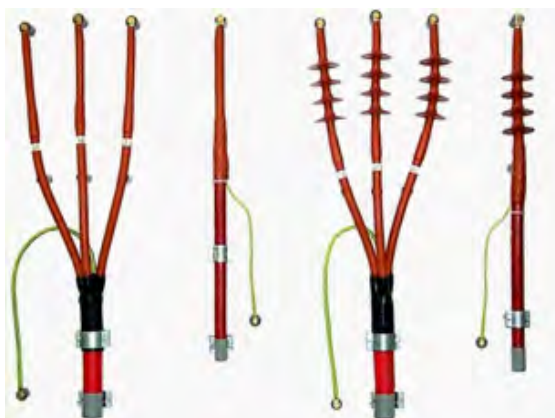

For the complete range of PROTOLON, PROTOMONT and TENAX medium voltage mining cables Prysmian Group offers

- Sealing end material sets for self-installation on site
- Termination in the factory according to customer specification



*Special sealing end termination
for Gothe-connection box*

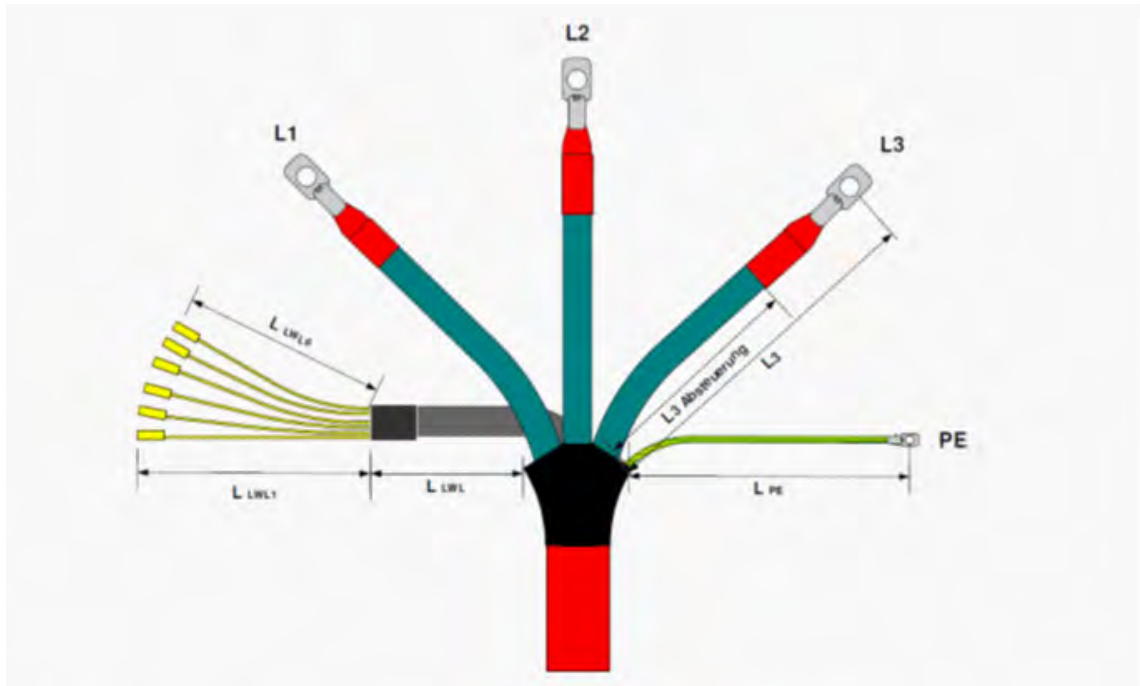

Core length:

L_1 :

L_2 :

L_3 :

L_{PE} :

Borehole cable lug:

$L_1 \dots L_3$: 16 Ø mm

PE: 12 Ø mm

FO-plug type:

Length of FO-element

L_{LWL1} :

L_{LWL2} :

L_{LWL3} :

L_{LWL4} :

L_{LWL5} :

L_{LWL6} :

L_{LWL7} :

L_{LWL8} :

L_{LWL9} :

L_{LWL10} :

L_{LWL11} :

L_{LWL12} :

Info:

The distances L_1 , L_2 , L_3 and PE are calculated between spread head and the center of the borehole cable lug.

Mining cables

Couplers and cable services

For several applications the cables have to be connected by couplers. There is a wide range for underground and opencast couplers available, which our service department can apply to the cable. Popular coupler-systems are the single core medium voltage connectors (interface A; B or C) e.g. Prysmian Group Formfit.



Prysmian Group Formfit medium voltage connectors

For outdoor applications (e.g. opencast mines) multicore couplers are available from different manufacturers.



Prysmian Group cable services:

- Assembling in the factory
- Delivery of material sets
- Erectors training sessions on site or in the factory
- Vulcanizing system, tools sets and materials for the cable repair

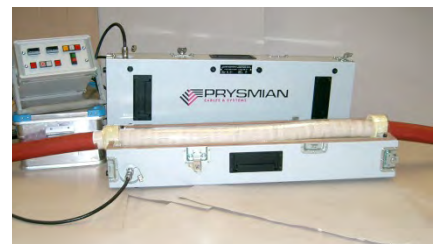

Electrical parameters

Voltages

For the rated, operating and test voltages of cables, the definitions given in DIN VDE 0298, Part 3, apply. Some of these are mentioned in the table below.

AC = Alternating Current

DC = Direct Current

Rated voltage

The rated voltage of an insulated electric cable is the voltage which is used as the basis for the design and the testing of the cable with regard to its electrical characteristics.

The rated voltage is expressed by the two values of power frequency voltage U_0/U in V.

U_0 = rms value between one conductor and „Earth“

U = rms value between two conductors of a multi-core cable or of a system of single-core cables

In a system with AC voltage, the rated voltage of a cable must be at least equal to the rated voltage of the system for which it is used. This requirement applies both to the value U_0 and the value U .

In a system with DC voltage, its rated voltage must not be more than 1.5 times the value of the rated voltage of the cable.

Operating voltage

The operating voltage is the voltage applied between the conductors and earth of a power installation with respect to time and place with trouble-free operation.

- Cables with a rated voltage U_0/U up to 0.6/1 kV
These cables are suitable for use in three-phase AC, single-phase AC and DC installations, the maximum continuously permissible operating voltage of which does not exceed the rated voltage of the cables by more than
10% for cables with a rated voltage U_0/U up to and including 450/750 V
20% for cables with a rated voltage $U_0/U = 0.6/1$ kV
- Cables with a rated voltage U_0/U greater than 0.6/1 kV
These cables are suitable for use in three-phase and single-phase AC installations, the maximum operating voltage of which does not exceed the rated voltage of the cable by more than 20%
- Cables in DC installations
If the cables are used in DC installations, the continuously permissible DC operating voltage between the conductors must not exceed 1.5 times the value of the permissible AC operating voltage.
In single-phase earthed DC installations this value should be multiplied by a factor of 0.5.

Mining cables

Test voltage

Regarding the test voltage of flexible cables, the values given in the corresponding parts of DIN VDE 0250 apply. If the relevant shield is missing, as for example with CORDAFLEX and PROTOMONT cables, „core against core“ is tested in appropriate combinations. The values are to be regarded as AC test voltages (unless stated otherwise) for single-phase testing, i.e. the AC test voltage is applied between the core and the corresponding shielding (e.g. semiconductive layer, earth conductor, shield). Telecommunication cores (pairs) and other shielded pairs (e.g. (2x1)C) are tested „core against core“ and „core against shield“ whereby the test voltages are correspondingly different. With single-core cables without shielding, the corresponding opposite pole is a water bath.

Rated voltage	Max. permissible operating voltage			Test voltage applied to the complete cable				
	in AC systems	in DC systems		Power cores		Control cores	Pilot cores	Tele-comm. Cores
		unearthed	single-phase earthed	AC	DC			
U_0/U	U_0/U	U kV	U kV	kV	kV	kV	kV	kV
250/250 V	275/275 V	0.412		1.5	3.75			
300/500 V	318/550 V	0.825	0.413	2	5			
450/750 V	476/825 V	1.238	0.619	2.5	6.25			
0.6/1 kV	0.7/1.2 kV	1.8	0.9	2.5	6.25	2		
0.6/1 kV	0.7/1.2 kV	1.8	0.9	4	10	2	2	1
1.8/3 kV	2.1/3.6 kV	5.4	2.7	6	15	2	2	1
3.6/6 kV	4.2/7.2 kV	10.8	5.4	11	27.5	2	2	1
6/10 kV	6.9/12 kV	18	8	17	42.5	2	2	1
8.7/15 kV	10.4/18 kV	27	14	24	60.0	2	2	1
12/20 kV	13.9/24 kV	36	18	29	72.5	2	2	1
14/25 kV	17.3/30 kV	45	23	36	90.0	2	2	1
18/30 kV	20.8/36 kV	54	27	43	107.5	2	2	1
20/35 kV	24.3/42 kV	63	32	50	125	2	2	1

Permissible short-circuit current at max. permissible short-circuit temperatures of the conductor surface and for a fault duration $t_{kr} = 1$ s

Cross-section mm ²	1	1.5	2.5	4	6	10	16	25	35	50	70	95	120	150	185	240	300	400
	Short-circuit current (kA)																	
	0.143	0.215	0.358	0.572	0.858	1.43	2.29	3.58	5.01	7.15	10.01	13.6	17.16	21.45	26.46	34.32	42.9	71.5

The short-circuit current-carrying capacity I_{thz} for a short-circuit duration t_k deviating from $t_{kr} = 1$ s, is:

$$I_{thz} = I_{thr} \cdot \sqrt{\frac{t_{kr}}{t_k}}$$

Voltage drop:

$$\Delta U = \sqrt{3} \times I_b \times l \times (R'_{w20} \times \cos \varphi + X'_L \times \sin \varphi)$$

For deviating conductor temperatures (e.g. 90°C instead of 20°C) the effective resistance R'_w has to be converted:

$$R'_{w90} = R'_{w20} (1 + (0.004 \times 70k))$$

For the practical use a more easier calculation may be sufficient:

$$\Delta U = \sqrt{3} \times I_b \times l \times R'_{w\Theta} \times \cos \varphi$$

I_b = load current [A]

l = cable length [km]

R'_{w20} = effective resistance per unit length and 20°C [Ω /km]

X'_L = Reactance per unit length [Ω /km]

φ = phase-angle

Mining cables

Electrical parameters

Current-carrying capacity

If, after all selection criteria have been taken into account, the type of flexible electric cable to be used for mining applications has been decided on, the necessary cross-section of the conductor can be determined either from the current to be transmitted or from the power.

Installation conditions (stretched laying, suspended freely in the air, reeled), variations in ambient temperature, grouping, type of operation (continuous duty, intermittent periodic duty) and the use of multi-core cables are to be taken into account.

The table below is valid for continuous duty at 30°C ambient temperature and three loaded cores, rubber-insulated or PVC-insulated cables.

Rubber-insulated

CORDAFLEX (S), PROTOLON, SUPROMONT, TENAX, FELTOFLEX up to 10 kV, PROTOMONT

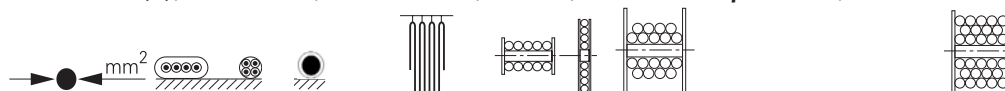

Cross-section mm ²	Stretched laying		Suspended freely in air	Reeled in						
	A Factor 1	A Factor 0.7		A	1 layer	2 layers	3 layers	4 layers	5 layers	6 layers
1	18	24	19	14	11	9	8	7	5	4
1.5	23	31	24	18	14	11	10	9	6	5
2.5	30	41	32	24	18	15	13	11	8	7
4	41	56	43	33	25	20	17	16	11	9
6	53	72	56	42	32	26	22	20	14	12
10	74	101	78	59	45	36	31	28	20	16
16	99	135	104	79	60	49	42	38	27	22
25	131	178	138	105	80	64	55	50	35	29
35	162	220	170	130	99	79	68	62	44	36
50	202	275	212	162	123	99	85	78	55	44
70	250	340	263	200	153	123	105	95	68	55
95	301	409	316	241	184	147	126	114	81	66
120	352	479	370	282	215	172	148	134	95	77
150	404	549	424	323	246	198	170	154	109	89
185	461	627	484	369	281	226	194	175	124	101
240	540	744	567	432	329	265	227	205	146	119
300	620	861	651	496	378	304	260	236	167	136

1) The reduction factor is also valid for flat reeling cables (spirally)

Rubber-insulated

PROTOLON, SUPROMONT, PROTOMONT, TENAX, FELTOFLEX from 15 kV

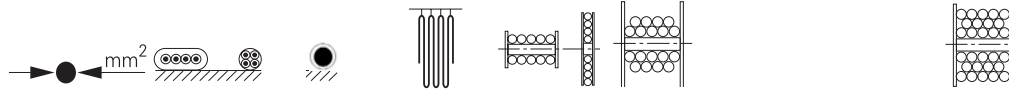

Cross-section mm ²	Stretched laying		Suspended freely in air 1.05	Reeled in						
	Factor 1	Factor 0.7		1 layer	2 layers	3 layers ¹⁾	4 layers	5 layers	6 layers	7 layers
16	105	143		84	64	51	44	40	28	23
25	139	189		111	85	68	58	53	38	31
35	172	234		138	105	84	72	65	46	38
50	216	294		172	131	105	90	82	58	47
70	265	360		212	162	130	111	101	72	58
95	319	434		255	195	156	134	121	86	70
120	371	505		297	226	182	156	141	100	82
150	428	582		342	261	210	180	163	116	94
185	488	664		390	298	239	205	185	132	107
240	574	782		459	350	281	241	218	155	126
300	660	861		528	403	323	277	251	178	145

PE-insulated

MSR-mining, L-2YY(Z)Y-KF40



2 x 2 x 1	12
5 x 2 x 1	8.5
10 x 2 x 1	6.5
20 x 2 x 1	5

Mining cables

Electrical parameters

De-rating factors

The de-rating factors take into account the installation and operating conditions, such as temperature, grouping, intermittent periodic duty and the number of simultaneously loaded cores. They are to be used for determining the current-carrying capacity in accordance with the tables on page 196/197.

De-rating factors for varying ambient temperatures

Ambient temperature °C															
10	15	20	25	30	35	40	45	50	55	60	65	70	75	80	85
1.15	1.12	1.08	1.04	1.0	0.96	0.91	0.87	0.82	0.76	0.71	0.65	0.58	0.50	0.41	0.29

De-rating factors for grouping

Arrangement		Number of multi-core cables or number of single or three-phase circuits made up of single-core cables (2 or 3 loaded conductors)															
		1	2	3	4	5	6	7	8	9	10	12	14	16	18	20	
Bunched directly at the wall, the floor, in conduit or ducting, on or in the wall		1.0	0.8	0.7	0.65	0.6	0.57	0.54	0.52	0.5	0.48	0.45	0.43	0.41	0.39	0.38	
Single layer on the wall or floor, touching		1.0	0.85	0.79	0.75	0.73	0.72	0.72	0.72	0.71	0.70						
Single layer on the wall or floor, spaced with a clearance of 1 x cable diameter between adjacent cables		1.0	0.94	0.9	0.9	0.9	0.9	0.9	0.9	0.9	0.9	0.9	0.9	0.9	0.9	0.9	
Single layer under ceiling, touching		0.95	0.81	0.72	0.68	0.66	0.64	0.63	0.62	0.61							
Single layer under ceiling, spaced with a clearance of 1 x cable diameter between adjacent cables		0.95	0.85	0.85	0.85	0.85	0.85	0.85	0.85	0.85	0.85	0.85	0.85	0.85	0.85	0.85	

De-rating factors for intermittent periodic duty

Ambient temperature	30°C	Nominal cross-section mm ²	Duty factor ED %			
			60	40	25	15
Duty cycle	10 min	0.75	1.00	1.00	1.00	1.00
		1	1.00	1.00	1.00	1.00
		1.5	1.00	1.00	1.00	1.00
		2.5	1.00	1.00	1.04	1.07
		4	1.00	1.03	1.05	1.19
		6	1.00	1.04	1.13	1.27
		10	1.03	1.09	1.21	1.44
		16	1.07	1.16	1.34	1.62
		25	1.10	1.23	1.46	1.79
		35	1.13	1.28	1.53	1.90
		50	1.16	1.34	1.62	2.03
		70	1.18	1.38	1.69	2.13
		95	1.20	1.42	1.74	2.21
		120	1.21	1.44	1.78	2.26
		150	1.22	1.46	1.81	2.30
		185	1.23	1.48	1.82	2.32
		240	1.23	1.49	1.85	2.36
300	1.23	1.50	1.87	2.39		

De-rating factors for multi-core cables with conductor cross-sections up to 10mm²

Number of loaded cores	De-rating factors
5	0.75
7	0.65
10	0.55
12	0.53
14	0.50
18	0.44
19	0.45
24	0.40
30	0.37
36	0.36
40	0.35
42	0.35
61	0.30

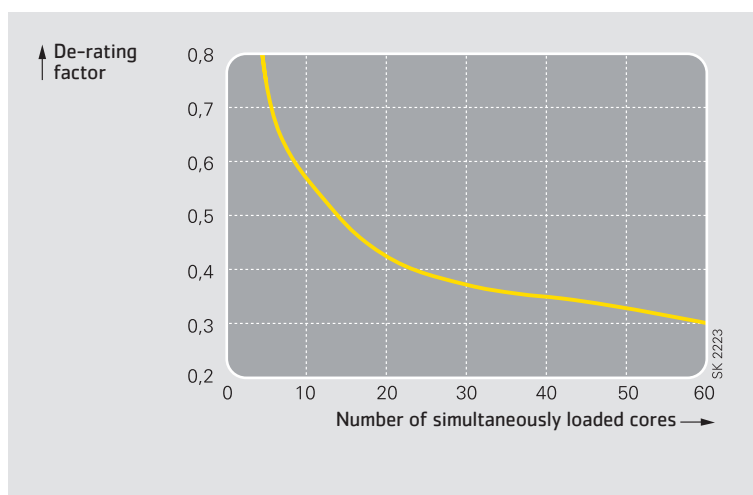

Mining cables

Monitoring of flexible cables in underground operations

Prysmian Group mining cables are designed for all possibilities of monitoring the cable during operation. Different installation standards in the countries require different levels of monitoring safety. Below there are two monitoring possibilities using devices such as

- Loop monitor
- Monitor / earth monitoring device
- insulation monitor
- High-Voltage monitor

All Prysmian Group mining cables may be used with the mentioned monitoring systems.

1. Single screen monitoring

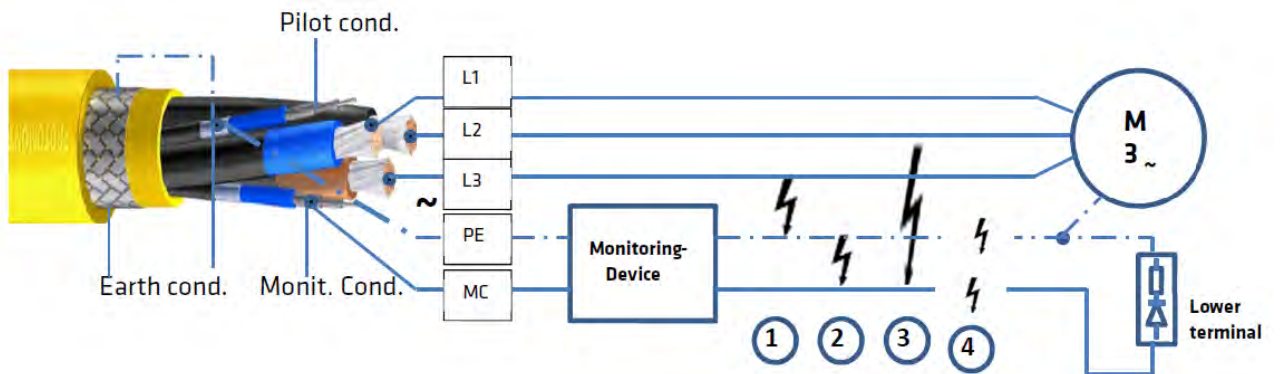

2. Double screen monitoring

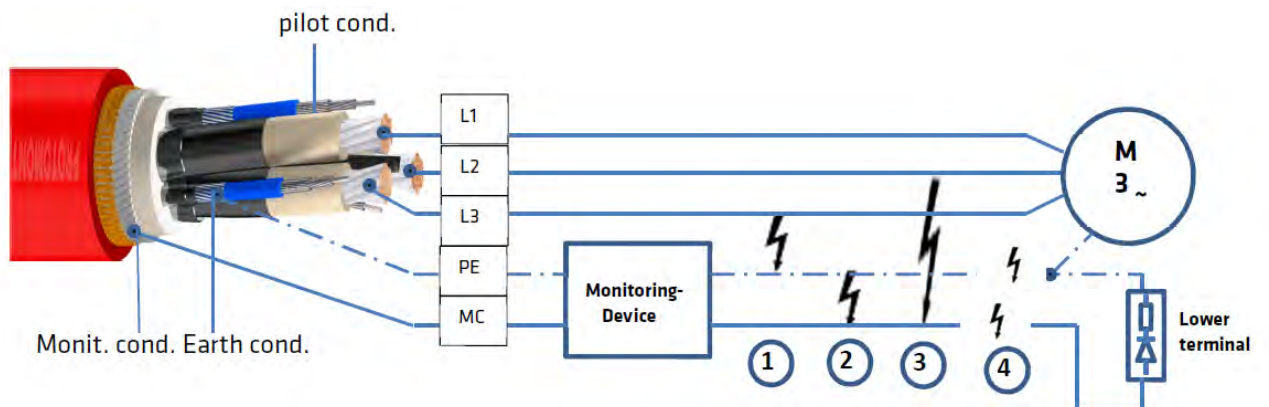

- | | | |
|---|---|---|
| 1 | = | short circuit phase/protective earth conductor |
| 2 | = | short circuit protective earth conductor/monitoring conductor |
| 3 | = | short circuit phase/monitoring conductor |
| 4 | = | break of protective earth or monitoring conductor |

Thermal parameters

The different temperature limits of the individual flexible electric cables for mining applications are summarized in the table below.

Under no circumstances may the values shown be exceeded due to interaction of internal Joule heat and the ambient temperature.

If cables are exposed to radiation, e.g. sunlight, the temperature of the outer sheath of the flexible electric cable can rise to a level which is significantly higher than the ambient temperature. This situation must be compensated for by corresponding reduction of the current-carrying capacity.

The temperatures on the surface of the cable are limits for the ambient temperature.

All insulating and sheathing compounds of the flexible electric cables become stiffer as the temperature drops. If the temperature falls below the specified limit, a point can be reached below which the compounds used become brittle.

In addition to this, more force (sometimes considerably more) is needed for bending a flexible electric cable due to the increase of stiffness of the insulating and sheathing compounds at lower temperatures. This can create problems in the use of the flexible electric cables (e.g. with the reel drive).

Flexible cables	Type	Temperature limit during operation, storage, installation and transport (°C)			
		of the conductor during operation	of the conductor during short-circuit	on the surface of the cable, fixed installation	on the surface of the cable, fully flexible installation
PROTOLON (M)-F	(N)TSCGEW0EU	90	250	-40 to +80	-25 to +60
PROTOLON (M)-R	(N)TSCGEW0EU	90	250	-40 to +80	-35 to +60
PROTOLON (SB)-SAM	(N)TSCGEW0EU	90	250	-40 to +80	-30 to +60
PROTOLON (ST)	NTSCGEW0EU	90	250	-40 to +80	-25 to +60
PROTOLON 1-core	NTMCGCW0EU	90	250	-40 to +80	-25 to +60
PROTOMONT (M)	(N)SH0EU	90	250	-40 to +80	-25 to +60
PROTOMONT	NSSH0EU	90	250	-40 to +80	-25 to +60
PROTOMONT (EMV-FC)	NSSHC0EU	90	250	-40 to +80	-25 to +60
OPTOFLEX		-	-	-40 to +80	-30 to +60
PROTOMONT MSR	2YSLGCG0EU	60	150	-40 to +60	-25 to +60
PROTOMONT (Z) and (V)	NSSHCGE0EU	90	250	-40 to +80	-20 to +60
SUPROMONT rubber	(N)3GHSSYCV	90	250	-40 to +80	+5 to +60
CORDAFLEX (S)	NSHT0EU	90	250	-40 to +80	-25 to +60
PROTOMONT (S)	NSHT0EU	90	250	-40 to +80	-25 to +60
PROTOMONT (VO)	NTSKCGE0EU	90	250	-40 to +80	-20 to +60
TENAX CTE	NSSHKCGE0EU	90	250	-40 to +80	-25 to +60
TENAX LK	NSSHKCGE0EU	90	250	-40 to +80	-25 to +60
PROTOMONT TBM	(N)TSCGECW0EU	90	250	-40 to +80	-20 to +60
TENAX HTT	NTSCGEW0EU	90	250	-40 to +80	-20 to +60
L-2YY(Z)Y-KF40	L-2YY(Z)Y	60		-55 to +60	-40 to +50
FELTOFLEX	NTMCW0EU	90	250	-40 to +80	-25 to +80
TENAX SAS	NTSCGEW0EU	90	250	-60 to +80	-50 to +60

Mining cables

Thermal parameters

The relationship between the bending stiffness of flexible electric cables for mining applications and the temperature is shown in the figure below.

The ratio of the bending force is given as F/F_0 , with $F_0 = F_{20^\circ\text{C}}$.

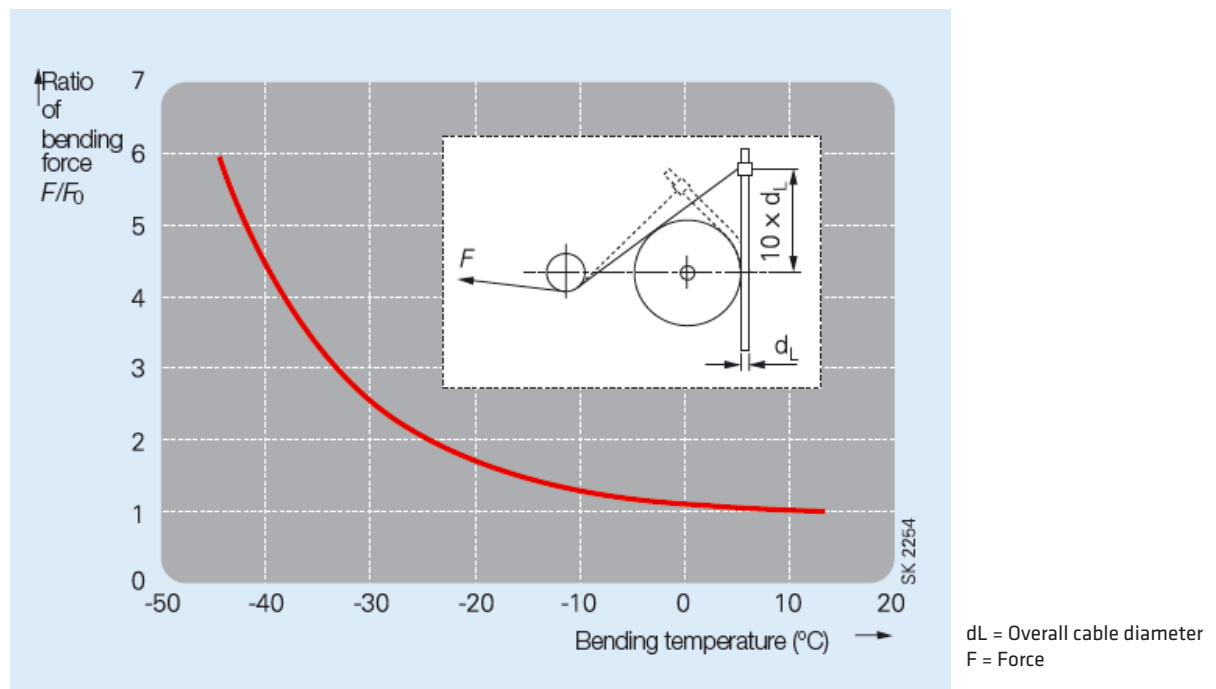

The temperature limits on the surface of the cable are specified to ensure problem-free and healthy operation during forced guidance of flexible electric cables for mining applications, especially while trailing over ground and during reeling operation.

Higher temperatures influence the hardness, abrasion, resistance to tear propagation and the transverse pressure stability of the insulating and sheathing compounds and can thus lead to a reduction of their service life.

Flexible electric cables should be selected, installed and operated so that the expected dissipation of Joule heat is not hindered in any way and therefore no risk of fire is incurred.

Mechanical parameters

Tensile loads

The tensile loads of copper conductors in flexible electric cables for mining applications as specified by DIN VDE 0298, Part 3, should not exceed 15 N/mm². However, higher values are allowed for some cables as shown in the table below. These values refer to tensile load only.

These maximum permissible limits of tensile load are to be regarded as the sum of the static and dynamic loads.

When the permissible tensile force is being calculated, shields, concentric conductors and split protective-earth conductors as well as integrated control cores and monitoring cores of power cables must not be included in the calculation.

For higher tensile loads, appropriate steps have to be taken such as increasing the bending radii or using special cable designs with stress relieving support elements. In some cases, a shorter service life can be expected. In this case, the cable manufacturer should be consulted.

The maximum permissible tensile load for installing fixed laying flexible cables is 15 N/mm² referred to the cross-section of the conductor.

Maximum tensile loads during installation and operation of flexible electric cables for mining applications

Flexible cables	Type	DIN VDE N/mm ²	Prysmian Group N/mm ²
PROTOLON (M)	R-(N)TSCGEW0EU	15	20
PROTOLON (M)	F-(N)TSCGEW0EU	15	15
PROTOLON (SB-SAM)	(N)TSCGEW0EU	15	20
PROTOLON (ST)	NTSCGEW0EU	15	15
PROTOLON 1-core	NTMCGCW0EU	15	15
PROTOMONT	(N)SHOEU, NSSHOEU	15	15
PROTOMONT EMV-FC	NSSHC0EU	15	15
OPTOFLEX (M)		-	2000 N for the cable
PROTOMONT MSR-mining	ZYSLGCG0EU	15	15
PROTOMONT (Z)	NSSHCGE0EU	15	> 40 kN breaking load of the braid
PROTOMONT (V)	NSSHCGE0EU	15	15
SUPROMONT rubber	(N)3GHSSYCY	15	15
CORDAFLEX (S)	NSHT0EU	15	30
TENAX M	(N)TSCGEW0EU	15	15
TENAX SAS	NTSCGEW0EU	15	25
TENAX CTE	NSSHCGE0EU	15	15
FELTOFLEX	NTMCW0EU	15	15
PROTOMONT(VO)	NTSCGECW0EU	15	15
TENAX LK	NTSKCGEW0EU	15	30
PROTOMONT(S)	(N)SSHCGE0EU	15	30
TENAX HTT	NTSCGECW0EU	15	15

Mining cables

Mechanical parameters

Torsional stresses

As a general rule the torsional stresses occurring during operation of flexible electric cables for mining applications are low. In certain applications, such as for example laying on large mobile equipment (cable booms), torsional stresses are unavoidable.

The maximum permissible torsional stresses which occur during operation at entries, slewing gears, windmills, etc., are summarized in the table below. If the limits are exceeded, this can lead to a reduction in service life. In critical cases, the cable manufacturer should be consulted.

Torsional stresses created by the systems involved (e.g. due to misalignment of cable guidance systems, oblique cable pay out) should be avoided and are not included here.

Maximum torsional stresses during operation of flexible electric cables for mining applications

Flexible cables	Type	α (°/m) 	
		With semiconductive rubber layer	With copper core shield
PROTOLON (M)-R und -F	(N)TSCGEWÖEU	± 100	-
PROTOLON (SB-SAM)	NTSCGEWÖEU	± 100	± 25
PROTOLON (ST)	NTSCGEWÖÜ	± 100	± 25
PROTOLON 1-core	NTMCGCWÖÜ	-	± 25
PROTOMONT	(N)SHÖU, NSSHÖU	± 100	± 25
PROTOMONT EMV-FC	NSSHCOEU	-	± 25
OPTOFLEX (M)		± 100	-
PROTOMONT MSR-mining	ZYSLGCGÖÜ	-	± 25
PROTOMONT (Z)	NSSHCGEÖÜ	± 10	-
PROTOMONT (V)	NSSHCGEÖÜ	± 25	-
SUPROMONT rubber	(N)3GHSSYCY	-	± 25
CORDAFLEX (S)	NSHTÖU	± 25	-
TENAX M	(N)TSCGEWÖEU	± 50	-
TENAX SAS	NTSCGEWÖEU	± 100	-
TENAX CTE	NSSHCGEOEU	± 50	-
FELTOFLEX	NTMCWÖEU	-	± 25
PROTOMONT(VO)	NTSCGECWÖEU	± 50	-
TENAX LK	NTSKCGEWÖEU	± 100	-
PROTOMONT(S)	(N)SSHCGEÖEU	± 50	-
TENAX HTT	NTSCGECWÖEU	± 100	-

Minimum bending radii





If the bending radii are smaller than those permitted, a reduced service life can be expected depending on the stress conditions. The values given in the table below should be taken as a basis.

The minimum bending radii are shown as the product of the overall diameter of the cable and a factor, which is dependent on the diameter of the cable (e.g.: 3 x d).

The minimum permissible bending radii are valid within the specified ambient temperature range (see thermal parameters page 201), subject to the provision that the permissible tensile loads are not exceeded (see mechanical parameters, page 203).

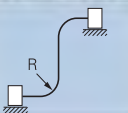
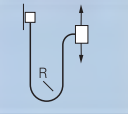
In critical cases, the cable manufacturer should be consulted.

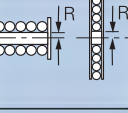
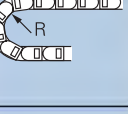
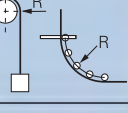
Minimum permissible bending radius R

Flexible cables		CORDAFLEX, PROTOMONT, MSR-Mining, TENAX	PROTOLON, SUPROMONT, TENAX
Rated voltage U_0/U		Up to 0.6/1 kV	Above 0.6/1 kV
	Fixed installation	4 x d	6 x d
	Fully flexible operation	5 x d	10 x d
	For the entry, e.g. at a centre feed point	5 x d	10 x d
	For forced guidance with reeling operation	6 x d	12 x d
	For forced guidance with power tracks	5 x d PROTOMONT (V)/(VO), TENAX CTE at max. 5 N/mm ² : 2.3 x d	10 x d
	For forced guidance with sheaves	7,5 x d	15 x d
	Drawing by means of a roller stirrup	4 x d	8 x d

d = Max. overall cable diameter

Mining cables

Mechanical parameters

Travel speeds

Flexible electric cables for mining applications are intended for use on mobile equipment and are designed to cope with the technical requirements of the application.

In order to collect, release and move flexible electric cables, there are different cable guidance systems such as reels, drum cars, power tracks, sheave guided cable storage systems as well as sheaves and multi-roller guides.

Mining equipment and consequently also the cable guidance systems are operated at different travel speeds and are therefore subject to stress which can vary from low to very high.

During operation of the mobile equipment, the flexible electric cables are subject to stress such as tension, transverse pressure, torsion and bending. Thus, the travel speed and the acceleration are to be considered as indirect criteria for the stresses applied to the flexible electric cables.

The maximum permissible travel speed for the individual flexible electric cables are summarized in the table below.

If the travel-speed limits are exceeded, a reduction in service life cannot be excluded. The cable manufacturer should be consulted.

Maximum travel speed for flexible electric cables for mining applications

Flexible cables	Type	Material handling equipment on tracks	Material handling equipment on caterpillar-type running gear	Loader operation or tyre mounted equipment	Rewinding with drum car
		m/min	m/min	m/min	m/min
PROTOLON (M)-R	(N)TSCGEW0EU	60	10	60	100
PROTOLON (SB-SAM)	NTSCGEW0EU	no application	10	no application	100
PROTOMONT (M)	(N)SH0EU, NSSH0EU	no application	no application	no application	100
CORDAFLEX (S)	NSHT0EU	no application	no application	160	100
PROTOMONT (Z)/(V)/(V0)	NSSHCGE0EU	Max. travel speed of the coal cutter 15 m/min			
TENAX M	(N)TSCGEW0EU	30	30	30	100
TENAX SAS	NTSCGEW0EU	-	10	-	100
TENAX CTE	NSSHCGE0EU	Max. travel speed of the coal cutter 15 m/min			
TENAX LK	NTSKCGE0EU	160	160	160	100
PROTOMONT(S)	(N)SSHCGE0EU	160	160	160	100
PROTOMONT TBM	(N)TSCGEW0EU	30	30	-	100
TENAX HTT	NTSCGECW0EU	30	30	-	100

Additional tests

Adequate testing of the operating characteristics needed for flexible electric cables for mining applications is not possible with the tests specified by DIN VDE. Our flexible electric cables for mining applications are therefore subject to additional and continuous mechanical tests at the manufacturer's facilities.

These additional tests facilitate time-compressed examination of the running and service characteristics under different kinds of mechanical stress, such as reserved bending strength, running over sheaves, flexing work and reeling operation in relation to tensile load and bending radii.

The additional tests are shown below and on the next two pages.

Schematic representation of the additional tests

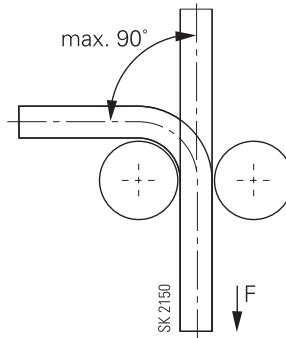
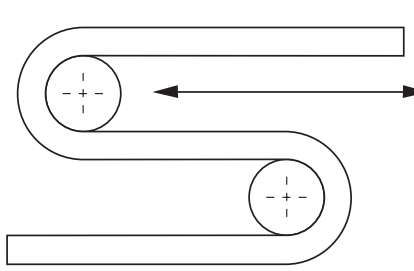
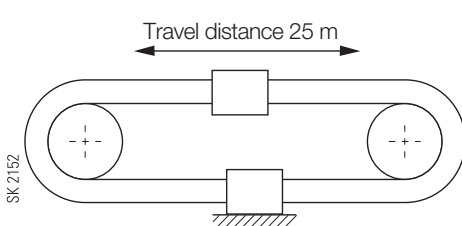
<p>Reversed bending test</p> <p>Based on DIN VDE 0281, Part 2</p> <p>Testing of flexible electric cables for mining applications under increased loads.</p> <p>Cable diameter up to 50 mm, maximum tensile load 3000 N.</p> <p>Each movement from one extreme position to another (180°) is counted as a cycle.</p>	
<p>Roller bending test type A</p> <p>Testing the roller bending characteristics of flexible electric cables for mining applications based on DIN VDE 0282, Part 2.</p> <p>Cable diameter up to 50 mm.</p> <p>Each movement between the extreme position is counted as a cycle.</p>	
<p>Roller bending test type B</p> <p>(Tender test)</p> <p>Practice-oriented testing of flexible electric cables for mining applications with reference to running and service characteristics.</p> <p>Cable diameter from 20 up to 60 mm.</p> <p>Each movement between the extreme position is counted as a cycle.</p>	

Mining cables

Mechanical parameters

Schematic representation of the additional tests

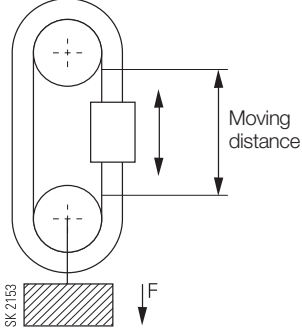
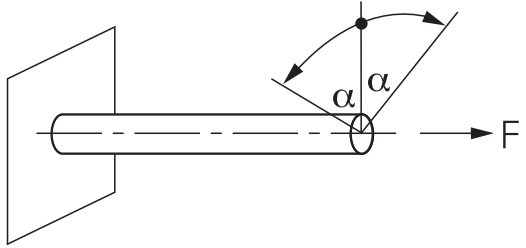
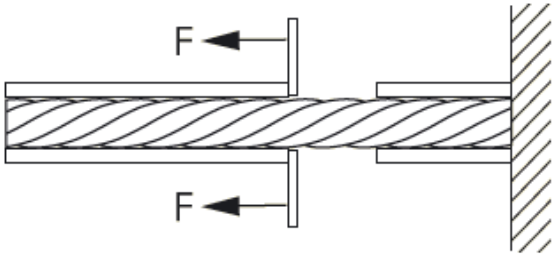
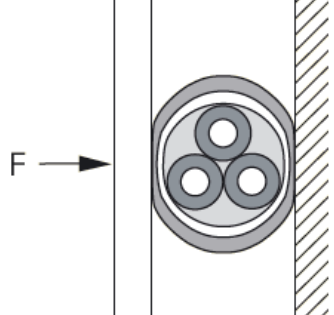
<p>Roller bending test type C (Flexing test)</p> <p>Testing the running characteristics (flexing) of flexible electric cables for mining applications for evaluation of the mechanical service characteristics.</p> <p>Cable diameter from 60 up to 120 mm.</p> <p>Each movement between the extreme position is counted as a cycle. Moving distance 2 m.</p>	
<p>Torsional stress test</p> <p>The cable is alternately twisted left and right through an angle α by application of the tensile force F.</p> <p>Torsional angle max. $\pm 360^\circ$ Torsional torque max. 200 Nm Tensile force max. 4000 N</p> <p>Test duration at temperatures: -40°C to $+50^\circ\text{C}$.</p>	
<p>Sheath shifting test</p> <p>Flexible electric cables for mining applications are generally stressed by dragging over the underground in open-cast mining applications.</p> <p>The test determines the magnitude of the force required to slide the sheath along the core.</p>	
<p>Transverse pressure test</p> <p>This test demonstrates the behaviour of electric cables subjected to transverse pressure, e.g. as a result of jamming in plant components, being hit by falling stones (blocks of stones), etc.</p> <p>The test is passed when no electrical event occurs up to the specified value (earth-fault or short-circuit).</p>	

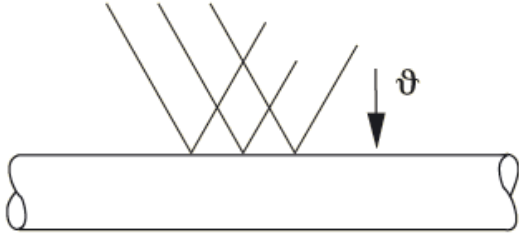
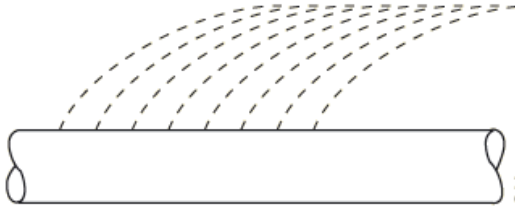
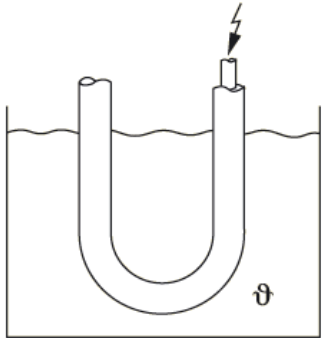
<p>Welding beads test</p> <p>During constructional and maintenance work on large mobile equipment such as excavators, putting-down machines, etc., welding beads can fall on previously installed electric cables. This test verifies the resistance of the outer sheath to such stresses.</p>	 <p>The diagram shows a horizontal cable with a coiled end on the left. Above the cable, several diagonal lines represent welding beads falling onto the surface. A downward-pointing arrow labeled with the Greek letter ϑ indicates the direction of the impact.</p>
<p>Brine resistance</p> <p>Automatic material handling and reloading installations (e.g. bunkering and blending plants) are sprayed with brine to prevent them from freezing in order to guarantee smooth trouble-free operation in winter. This test verifies the resistance of the outer sheath of mining-type cables to such stresses.</p>	 <p>The diagram shows a horizontal cable with a coiled end on the left. Above the cable, several dashed curved lines represent a spray of brine being directed at the cable's surface.</p>
<p>Water resistance</p> <p>During operation of flexible electric cables for mining applications, the possibility that they will be operated in water over considerable periods of time cannot be excluded. Verification of the resistance to water is carried out according to EN 50525-2-21.</p>	 <p>The diagram shows a U-shaped cable submerged in a container of water. The cable has a coiled end on the left and a vertical end on the right. A lightning bolt symbol is positioned above the vertical end, indicating an electrical test. A Greek letter ϑ is located in the bottom right corner of the diagram.</p>

Mining cables

Mechanical parameters

Additional tests

The following table depicts the test conditions for the individual flexible electric cables for mining applications. Under the severe conditions in mining operation, cables are subjected to considerable mechanical stresses, which by far exceed those defined in the requirement profile according to the VDE standards. These additional tests assure compliance with the special requirement profile for mining applications and document the suitability of our electric cables for all applications in open-cast and underground mines in a convincing manner. The tensile loads and the bending and sheave radii are specified and the minimum number of cycles which must be achieved. The decisive criterion for passing the mechanical test is the number of individual broken wires in the copper conductor and/or non-continuity of the electrical conductor. In the roller bending tests type A and B, the degree of deformation (cork-screwing effect) is tested additionally.

Additional mechanical tests		PROTOLON (M)	TENAX M	PROTOLON (M)	CORDAFLEX (S), PROTOMONT (S)	TENAX LK
		R-(N)TSCGEWÖU	(N)TSCGEWÖEU	F-(N)TSCGEWÖU	NSHTÖU, (N)SSHCGEÖEU	NTSKCGEÖEU
Reversed bending test	Tensile load	20 N/mm ²	10 N/mm ²	5 N/mm ²	20 N/mm ²	20 N/mm ²
	Bending diameter	10 x D	10 x D	10 x D	10 x D	10 x D
	Number of cycles	15 000	10 000	30 000	60 000	60 000
Roller bending test (test type A) D < 50 mm	Tensile load	15 N/mm ²		2.5 N/mm ²	5 N/mm ²	5 N/mm ²
	Bending diameter	10 x D		10 x D	10 x D	10 x D
	Number of cycles	50 000		30 000	200 000	200 000
Roller bending test (test type B) 20 mm < D < 60 mm	Tensile load				5 N/mm ²	5 N/mm ²
	Bending diameter				320 mm	320 mm
	Number of cycles				300 000	300 000
Roller bending test (test type C) 60 mm < D < 120 mm	Tensile load	20 N/mm ²	20 N/mm ²	20 N/mm ²	20 N/mm ²	20 N/mm ²
	Bending diameter	10 x D	10 x D	10 x D	10 x D	10 x D
	Number of cycles	30 000	10 000	15 000	30 000	30 000
Torsional stress test	Tensile load	10 N/mm ²	10 N/mm ²	10 N/mm ²		
	Torsional angle	± 100 °/m	± 100 °/m	± 100 °/m		
	Number of cycles	50 000	25 000	50 000		
Sheath shifting test	Pulling speed	20 mm/min		20 mm/min		
	Shifting force	> 20 kN		> 10 kN		
Transverse pressure test	Pressure force	> 150 kN		> 150 kN		
	Degree of deformation	< 50%		< 50%		
Resistance to welding beads	Testing temperature	450 °C	450 °C	450 °C	450 °C	450 °C
	Criterion	no damage	no damage	no damage	no damage	no damage
Brine resistance	Storage in	27 % brine solution		27 % brine solution		
	Temperature	60 °C		60 °C		
	Duration	14 days		14 days		
Water compatibility according to EN 50525-2-21	Duration of storage in water	100 days		100 days		
	Temperature	50 °C		50 °C		

PROTOLON (SB-SAM)	TENAX SAS	PROTOLON (ST)	PROTOMONT (Z)	PROTOMONT (V)/(VO)	TENAX CTE	PROTOMONT (M)	OPTOFLEX (M)
NTSCGEWOU	NTSCGEWOEU	NTSCGEWOU	NSSHCGEOU	NSSHCGEOU/ NTSCGECWOEU	NSSHCGEOEU	(N)SHOU	
	20 N/mm ²					5 N/mm ²	300 N
	10 x D					10 x D	250 mm
	30 000					30 000	50 000
						2.5 N/mm ²	300 N
						10 x D	250 mm
						30 000	75 000
	20 N/mm ²		30 N/mm ²	5 N/mm ²	5 N/mm ²	15 N/mm ²	
	10 x D		10 x D	5 x D	5 x D	10 x D	
	30 000		5 000	3 000	3 000	30 000	
						10 N/mm ²	300 N
						± 100 °/m	± 120 °/m
						50 000	50 000
20 mm/min	20 mm/min						
> 10 kN	> 10 kN						
						> 50 kN	
						< 50%	
450 °C	450 °C	450 °C	450 °C	450 °C	450 °C	450 °C	450 °C
no damage	no damage	no damage	no damage	no damage	no damage	no damage	no damage
						27 % brine solution	27 % brine solution
						60 °C	60 °C
						14 days	14 days
		100 days				100 days	100 days
		50 °C				50 °C	50 °C

Mining cables

Chemical parameters

Resistance to chemicals

The individual basic types of materials used for flexible electric cables for mining applications, such as PCP or EPR can be very different from each other in their resistance to chemicals depending on the required properties. Furthermore, the properties of the materials can vary greatly from manufacturer to manufacturer.

Other factors which influence flexible electric cables for mining applications, such as the concentration and degree of wetting of the chemicals, their temperature and the penetration time have different effects on the resistance to chemicals and have to be investigated from case to case.

The chemical industry has drawn up a table which shows a rough summary of the resistance to chemicals of various basic types of material; the overview in the table below is **not** to be deemed a substitute for a detailed examination.

Chemical	Material				
	EPR	PVC	CSM	PCP	PU
Aceton	Resistant	Non-resistant	Limited resistance	Limited resistance	Not tested
Acetic acid, 30 %	Non-resistant	Non-resistant	Limited resistance	Limited resistance	Limited resistance
Aluminium chloride solution	Resistant	Resistant	Resistant	Resistant	Not tested
Aluminium sulfate solution	Resistant	Resistant	Limited resistance	Limited resistance	Not tested
Ammonia, anhydrous	Resistant	Limited resistance	Resistant	Resistant	Not tested
Ammonium chloride solution	Resistant	Resistant	Resistant	Resistant	Not tested
Ammonium hydroxide solution	Resistant	Not tested	Resistant	Resistant	Not tested
Ammonium sulfate solution	Resistant	Resistant	Resistant	Resistant	Not tested
Amyl acetate	Limited resistance	Not tested	Limited resistance	Limited resistance	Not tested
Aniline	Limited resistance	Non-resistant	Non-resistant	Non-resistant	Not tested
Asphalt	Non-resistant	Limited resistance	Limited resistance	Limited resistance	Resistant
Benzene	Non-resistant	Non-resistant	Limited resistance	Resistant	Resistant
Benzole	Non-resistant	Non-resistant	Non-resistant	Non-resistant	Non-resistant
Borax solution	Resistant	Resistant	Resistant	Resistant	Not tested
Boric acid solution	Resistant	Resistant	Resistant	Resistant	Not tested
Butyl acetate	Limited resistance	Non-resistant	Non-resistant	Non-resistant	Not tested
Calcium bisulphite solution	Resistant	Not tested	Limited resistance	Limited resistance	Not tested
Calcium chloride solution	Resistant	Resistant	Resistant	Resistant	Not tested
Calcium hydroxide solution	Resistant	Not tested	Resistant	Resistant	Not tested
Carbon disulphide	Non-resistant	Non-resistant	Non-resistant	Non-resistant	Not tested
Carbon tetrachloride	Non-resistant	Non-resistant	Non-resistant	Non-resistant	Non-resistant
Chlorobenzene	Non-resistant	Non-resistant	Non-resistant	Non-resistant	Not tested
Chloroacetic acid	Limited resistance	Not tested	Limited resistance	Limited resistance	Not tested
Chlorine gas, wet	Limited resistance	Non-resistant	Non-resistant	Limited resistance	Not tested
Chlorine gas, dry	Limited resistance	Non-resistant	Limited resistance	Limited resistance	Not tested
Chloroform	Non-resistant	Non-resistant	Non-resistant	Non-resistant	Not tested
Copper chloride solution	Resistant	Not tested	Resistant	Resistant	Not tested
Copper sulphate solution	Resistant	Not tested	Resistant	Resistant	Not tested
Cyclohexane	Non-resistant	Non-resistant	Limited resistance	Non-resistant	Not tested
Dibutylphthalate	Limited resistance	Non-resistant	Not tested	Non-resistant	Not tested
Diesel oils	Non-resistant	Resistant	Resistant	Resistant	Resistant
Ethyl acetate	Limited resistance	Non-resistant	Non-resistant	Non-resistant	Not tested
Ethyl alcohol	Resistant	Not tested	Not tested	Not tested	Not tested
Ethylene glycol	Resistant	Limited resistance	Resistant	Resistant	Resistant

Resistant
Limited resistance
Non-resistant
Not tested

Chemical	Material				
	EPR	PVC	CSM	PCP	PU
Ethylen oxide	Non-resistant	Not tested	Limited resistance	Non-resistant	Not tested
Formaldehyde, 10 %	Resistant	Not tested	Resistant	Resistant	Not tested
Fuel oil	Non-resistant	Not tested	Limited resistance	Limited resistance	Not tested
Glycerine	Resistant	Not tested	Resistant	Resistant	Not tested
Hydraulic oils	Non-resistant	Limited resistance	Resistant	Resistant	Resistant
Hydrochloric acid, 20 %	Resistant	Resistant	Resistant	Limited resistance	Non-resistant
Hydrogen sulphide	Resistant	Resistant	Resistant	Limited resistance	Not tested
Kerosine	Non-resistant	Limited resistance	Non-resistant	Non-resistant	Not tested
Lactic acid	Resistant	Not tested	Resistant	Limited resistance	Not tested
Linseed oil	Non-resistant	Not tested	Limited resistance	Limited resistance	Not tested
Lubricating oils	Non-resistant	Resistant	Limited resistance	Limited resistance	Not tested
Magnesium chloride solution	Resistant	Resistant	Resistant	Resistant	Not tested
Methanol	Resistant	Resistant	Resistant	Resistant	Resistant
Methyl chloride	Non-resistant	Non-resistant	Non-resistant	Non-resistant	Not tested
Methyl ethyl ketone	Resistant	Non-resistant	Limited resistance	Limited resistance	Not tested
Methyl alcohol	Resistant	Limited resistance	Resistant	Resistant	Non-resistant
Mineral oil	Non-resistant	Non-resistant	Limited resistance	Limited resistance	Not tested
Naphta	Non-resistant	Not tested	Non-resistant	Limited resistance	Not tested
Naphtalene	Non-resistant	Non-resistant	Non-resistant	Limited resistance	Not tested
Nitric acid, 10 %	Resistant	Resistant	Limited resistance	Limited resistance	Not tested
Perchlor ethylene	Non-resistant	Non-resistant	Non-resistant	Non-resistant	Not tested
Petroleum	Non-resistant	Non-resistant	Limited resistance	Limited resistance	Resistant
Phenol	Non-resistant	Non-resistant	Non-resistant	Non-resistant	Not tested
Phosphoric acid	Resistant	Resistant	Resistant	Resistant	Limited resistance
Picric acid	Resistant	Resistant	Resistant	Resistant	Non-resistant
Potassium chloride	Resistant	Resistant	Resistant	Resistant	Resistant
Pyridine	Non-resistant	Non-resistant	Non-resistant	Non-resistant	Not tested
Soap solution	Resistant	Resistant	Resistant	Resistant	Not tested
Sodium hydroxide, 25 %	Resistant	Limited resistance	Resistant	Resistant	Non-resistant
Sodium hypochloride	Resistant	Not tested	Resistant	Limited resistance	Not tested
Soya bean oil	Non-resistant	Non-resistant	Limited resistance	Limited resistance	Not tested
Sulphur	Resistant	Resistant	Resistant	Resistant	Limited resistance
Sulphurous acid	Resistant	Resistant	Resistant	Limited resistance	Not tested
Sulphuric acid < 50%	Resistant	Resistant	Resistant	Resistant	Non-resistant
Stearic acid	Resistant	Limited resistance	Resistant	Resistant	Not tested
Toluene	Non-resistant	Non-resistant	Non-resistant	Non-resistant	Not tested
Transformer oil	Non-resistant	Resistant	Resistant	Resistant	Resistant
Tributyl phosphate	Limited resistance	Not tested	Non-resistant	Limited resistance	Not tested
Trichlorethylene	Non-resistant	Non-resistant	Non-resistant	Non-resistant	Non-resistant
Triethanolamine	Resistant	Not tested	Resistant	Limited resistance	Not tested
Turpentine	Non-resistant	Non-resistant	Non-resistant	Non-resistant	Not tested
Vegetable oils and grease	Limited resistance	Limited resistance	Resistant	Resistant	Resistant
Water	Resistant	Resistant	Resistant	Resistant	Limited resistance
Xylene	Non-resistant	Non-resistant	Non-resistant	Non-resistant	Not tested
Zinc chloride solution	Resistant	Resistant	Resistant	Resistant	Not tested

Resistant
Limited resistance
Non-resistant
Not tested

Mining cables

Conductors

Conductors for flexible electric cables are designed according to DIN EN 60228 (VDE 0295). Nowadays, the conductors are made of copper (Cu). Aluminium and other materials have not found general acceptance. An overview of the common kinds of conductors is shown here:

Abbreviation	Designation	Specification/regulation
RE conductor	Circular, solid	DIN VDE 0295 Class 1
RM conductor	Circular, stranded	DIN VDE 0295 Class 2
RMV conductor	Circular, stranded, compacted	DIN VDE 0295 Class 2
F conductor	Finley stranded	DIN VDE 0295 Class 5
FS conductor	Very finely stranded	Prysmian specification
FF conductor	Extremely finely stranded	DIN VDE 0295 Class 6

In many countries, the design of the conductors according to DIN VDE 0295 is accepted. The regulation corresponds to EN 60228 and IEC 60228.

The conductor classes F, FS and FF are employed for flexible electric cables for mining applications. The conductor classes are divided into nominal cross-sections. The individual conductor classes F, FS and FF and the nominal cross-section are defined by specification of the maximum diameter of the single wires and by the maximum resistance of the conductor at 20 °C (see also the table below).

These flexible conductors are made of bare or tinned annealed copper. The conductors are constructed of many single wires, all of which must have the same diameter.

Nominal Cross-section mm ²	Max. diameter of the single wires mm			Resistance of the conductor at 20 °C Ω/km	
	F conductor (Class 5)	FS conductor (Prysmian Group)	FF conductor (Class 6)	Bare single wires	Tinned single wires
0.5	0.21	0.16	0.16	39	40.1
0.75	0.21	0.16	0.16	26	26.7
1	0.21	0.16	0.16	19.5	20
1.5	0.26	0.21	0.16	13.3	13.7
2.5	0.26	0.21	0.16	7.98	8.21
4	0.31	0.26	0.16	4.95	5.09
6	0.31	0.26	0.21	3.30	3.39
10	0.41	0.26	0.21	1.91	1.95
16	0.41	0.31	0.21	1.21	1.24
25	0.41	0.31	0.21	0.780	0.795
35	0.41	0.31	0.21	0.554	0.565
50	0.41	0.36	0.31	0.386	0.393
70	0.51	0.36	0.31	0.272	0.277
95	0.51	0.41	0.31	0.206	0.210
120	0.51	0.41	0.31	0.161	0.164
150	0.51	0.41	0.31	0.129	0.132
185	0.51	0.41	0.41	0.106	0.108
240	0.51	0.41	0.41	0.0801	0.0817
300	0.51	0.41	0.41	0.0641	0.0654

The conductors used in flexible electric cables for mining applications are summarized in the table below.

The conductor for flexible electric cables is designed according to EN 60228 (VDE 0295), as described in the table below and especially in the table on the left page. The construction of the conductor itself and its design features are open to variation.

Flexible cable	Type	Conductor used
PROTOLON (M)	R-(N)TSCGEW0EU	Electrolytic copper not tinned, very finely stranded, Class "FS"
PROTOLON (M)	F-(N)TSCGEW0EU	Electrolytic copper not tinned, finely stranded, Class "F"
PROTOLON (SB-SAM)	(N)TSCGEW0EU	Electrolytic copper not tinned, finely stranded, Class "F"
PROTOLON (ST)	NTSCGEW0EU	Electrolytic copper tinned, finely stranded, Class "F"
PROTOLON 1-core	NTMCGCW0EU	Electrolytic copper tinned, finely stranded, Class "F"
OPTOFLEX (M)		Fibre-optics, no copper conductors
PROTOMONT (M)	(N)SHOEU	Electrolytic copper not tinned, finely stranded, Class "F"
PROTOMONT	NSSH0EU	Electrolytic copper tinned, finely stranded, Class "F"
PROTOMONT (Z)/(V)/(VO)	NSSHC0EU	Electrolytic copper tinned, finely stranded, Class "FS"
SUPROMONT	(N)3GHSSYCY	Electrolytic copper not tinned, finely stranded, Class "F"
CORDAFLEX (S)	NSHT0EU	Electrolytic copper tinned, very finely stranded, Class "FS"
PROTOMONT EMV-FC	NSSHC0EU	Electrolytic copper tinned, finely stranded, Class "F"
TENAX M	(N)TSCGEW0EU	Electrolytic copper not tinned, finely stranded, Class "F"
TENAX SAS	NTSCGEW0EU	Electrolytic copper tinned, finely stranded, Class "F"
TENAX CTE	NSSHC0EU	Electrolytic copper tinned, very finely stranded, Class "FS"
FELTOFLEX 1-core	NTMCW0EU	Electrolytic copper tinned, finely stranded, Class "F"
PROTOMONT(S)	(N)SSHC0EU	Electrolytic copper tinned, very finely stranded, Class "FS"
TENAX LK	NTSKCGEW0EU	Electrolytic copper tinned, very finely stranded, Class "FS"
TENAX HTT	NTSCGECW0EU	Electrolytic copper tinned, finely stranded, Class "F"

Mining cables

Conductors

The figure shows the design elements of a conductor for flexible electric cables for mining applications. Depending on the cross-section of the conductor, a flexible conductor consists of one or more strands which are laid up around a central strand in several layers. In the diagram, six individual strands (second layer) are laid up around a central strand (first layer). A third layer would then be made from $6 + 6 = 12$ individual strands, arranged around the second layer.

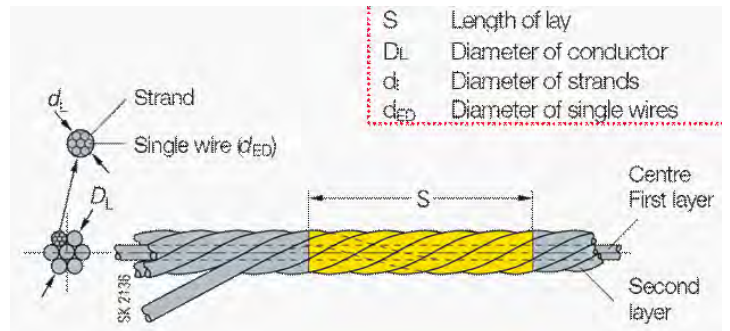

The strands of the flexible conductors consist of many single wires bunched together. The single wires can be laid up (bunched) to the right or left, thus determining the direction of lay. This is shown in the figure as the Z direction of lay (right) or the S direction of lay (left).

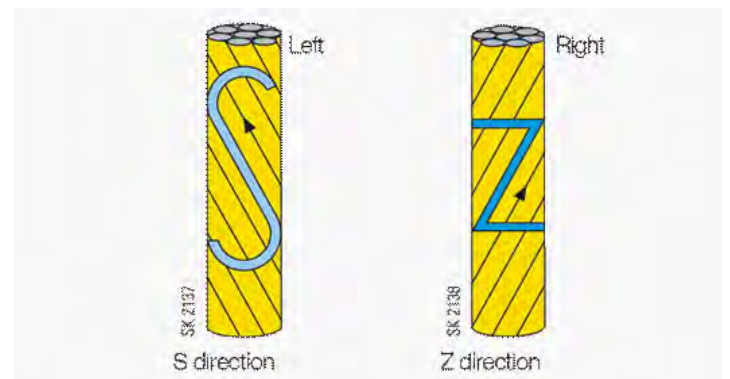

This also applies to a conductor which is laid up of single strands.

The conductor design and the nominal cross-section of the flexible F, FS and FF conductors for flexible electric cables are usually as shows in the table.

Conductor design		
	Bunched	Stranded
F conductor	up to 10 mm ²	from 16 mm ²
FS conductor	up to 2.5 mm ²	from 4 mm ²
FF conductor	up to 2.5 mm ²	from 4 mm ²

Depending on the combination of the individual design elements of a conductor, there are three basic types of conductors (see table):

The main advantage of the **uniform-lay conductor** is its high flexibility. As a result of its design, the conductor also has a smaller diameter than other types of conductors. Disadvantages are its susceptibility to torsional loads (unstable) and its poor resistance to axial compression and sharp bending. The uniform-lay conductor is used for all TENAX cables.

The **alternating-lay conductor** is very stable with respect to torsional loads and is not sensitive to axial compression and sharp bending. A disadvantage is its relatively low flexibility. As a result of its design the many crossing points of the single wires cause a lot of friction, which can lead to early breaking of the conductor, as compared to the other two types of conductors. The alternating-lay conductor has the largest diameter compared to the other two types of conductors.

The design of the **opposite-lay conductor** best meets the requirements of flexible electric cables for mining applications. It combines the advantages of both the uniform-lay conductor and the alternating-lay conductor without any of their disadvantages. The conductor is highly flexible, remains stable with respect to torsional loads and exhibits high axial compression and sharp bending strength. It has proven its excellent characteristics in many years of practice. The opposite-lay conductor is used for CORDAFLEX, PROTOMONT, SUPROMONT and PROTOLON.

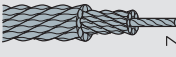
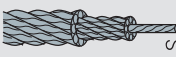
Types of conductor				
Uniform-lay conductor		Design	Strand	Layer
		Centre	Z	
		2 nd layer	Z	Z
		3 rd layer	Z	Z
Alternating-lay conductor		Design	Strand	Layer
		Centre	Z	
		2 nd layer	S	Z
		3 rd layer	Z	S
Opposite-lay conductor		Design	Strand	Layer
		Centre	S	
		2 nd layer	S	Z
		3 rd layer	S	Z

Mining cables

Compounds

Insulating and sheathing compounds

The table below gives an overview of all common compounds used for flexible electric cables. A basic distinction is made between thermoplastics and elastomers:

Thermoplastics, generally known as plastic, are usually **not cross-linked**

Elastomers, generally known as rubber, are always **cross-linked**

Serial No.	Material	Abbreviation	Type designation	
			VDE	Harm.
Thermoplastics				
1	Polyvinyl chloride	PVC	Y	V
2	Cross-linked polyvinyl chloride	PVC	X	V4
3	Polyethylene	PE	2Y	E
4	Cross-linked polyethylene	XLPE	2X	X
5	Low-pressure polyethylene	PE	2Yn	E2
6	Foam polyethylene	PE	02Y	
7	Polystyrene	PS	3Y	Q3
8	Polyamide	PA	4Y	Q4
9	Polytetrafluor ethylene	PTFE	5Y	E4
10	Perfluor ethylene propylene	PEP	6Y	E5
11	Ethylene tetrafluor ethylene	ETFE	7Y	E6
12	Polyimide	PI	8Y	Q5
13	Polypropylene	PP	9Y	E7
14	Polyvinylidene fluoride	PVDF	10Y	Q6
15	Polyurethane	TPU/PU	11Y	Q
16	Polyterephthalic acid ester	PETP	12Y	Q2
17	Polyester thermoplastic		13Y	
18	Perfluor ethylene oxyalkane	PFA	14Y	
19	Polychlorotrifluor ethylene	ECTFE	15Y	
Elastomers				
20	Natural rubber	NR	G	R
21	Synthetic rubber	SR	G	R
22	Styrene-butadiene rubber	SBR	G	R
23	Silicon rubber	SIR	2G	S
24	Isobuthylene-isoprene rubber	IIR	3G	B3
25	Ethylene-propylene rubber	EPR/EPDM	3G	B
26	Ethylene vinylacetate	EVA	4G	G
27	Chloroprene rubber	CR	5G	N
28	Chlorosulfonated polyethylene	CSM	6G	N4
29	Fluor elastomers		7G	
30	Nitrile butadiene rubber	NBR	8G	N5
31	Chlorated polyethylene	CM/CPE	9G	

Notes

Y: Type designation for a thermoplastic material

G: Type designation for an elastomeric material

X: Type designation for a cross-linked thermoplastic material (the letter „X“ replaces the „Y“ in „2X“ for cross-linked polyethylene)

0: Additional designation for foam materials (the zero is placed in front of the relevant type designation, e.g. „02Y“ for foamed PE)

The insulating and sheathing compounds, which are employed in flexible electric cables for mining applications constructed according to the existing VDE standards listed below, are compared with respect to the individual requirements in the table below. The characteristics are specified in DIN VDE 0207 or EN 50290 and allow a preliminary estimation of the properties of these compounds.

Requirements		Unit	Compound			
			Sheath	Sheath	Sheath	Insulation
			CR/CM	CR/CM	SR	EPR
			5GM3	5GM5	GM1b	3GI3
Max. permissible operating temperature at the conductor		°C	90	90	90	90
Tensile strength before ageing	min.	N/mm ²	10.0	15.0	4.2	4.2
Elongation at break before ageing	min.	%	300	300	200	200
Ageing	at	°C	100 ±2	100 ±2	100 ±2	135 ±2
	over	d	7.0	7.0	7.0	7.0
Change in tensile strength after ageing	max.	%	±30	±30	-	±30
Elongation at break after ageing	min.	%	250	250	200	-
Change in elongation at break after ageing	max.	%	±40	±40	-	±30
Abrasion	max.	mm ³	-	300	-	-
Resistance to tear propagation	min.	N/mm	-	30	-	-
Thermal expansion	at	°C	100 ±2	100 ±2	-	200 ±3
	over	min.	15	15	15	15
	with	N/cm ²	20	20	20	20
	loaded max.	%	175	175	175	175
	relieved max.	%	25	25	25	25
Resistance to oil (ASTM Oil No. 2)	at	°C	100 ±2	100 ±2	-	127 ±1
	over	h	24	24	-	40
	with	bar	-	-	-	5.5 ±0.2
Change in tensile strength	max.	N/mm ²	±40	±40	-	±30
Change in elongation at break	max.	%	±40	±40	-	±30
Surface resistance at 20°C	min.	Ω	10 ⁹	10 ⁹	10 ⁹	-
Volume resistance at 20°C	min.	Ω x cm	-	-	-	10 ¹²

Mining cables

Shield

The shield is a „barrier“ against electromagnetic fields and protects electric signals against external signals. The aim is to weaken or stop unwanted signals to such an extent that the wanted data signals can be transmitted without interference in the endangered signalling conductor. There are three basic types of shield structure:

- Overall shield over several cores
- Shielded pairs
- Individually shielded cores.

An overall sheath over several cores, which as a rule is situated between the inner and outer sheath of a cable, has not found general acceptance for reeling cables, because as a result of frequent bending the tensile and pressure forces within the cable lead to premature destruction of the shields and to failure of the cable.

Shielded pairs and individually shielded cores, on the other hand, have proven themselves in practice and are successfully used in Prysmian Group cables.

Braided screens are characterized by their transfer impedance which is defined as the ratio of the voltage drop along the shield on the interfered side to the parasitic current on the other side. The transfer impedance R_k (DIN 40500) is given for a specific frequency in $m\Omega/m$ and is usually plotted with respect to frequency. The lower the transfer impedance of a shield, the better the screening effect. The transfer impedance of the braided screens usually used for flexible electric cables for mining applications is optimized at 30 MHz and is therefore focussed on data-processing quality.

A typical transfer impedance characteristic is shown in the diagram.

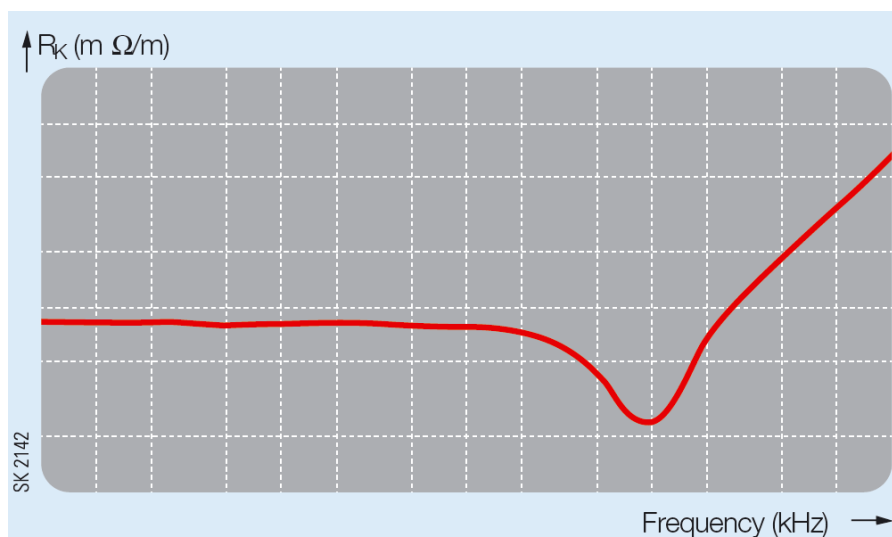

Electrical field control with cables

The cores of MV-reeling and trailing cables of voltage level 6 kV and above are always equipped with inner and outer semiconductive layers made of semiconductive rubber.

The inner and outer semiconductive layers are extruded with the insulation in a single-pass operation. Secure bonding to the insulation is obtained as a result of this method of extrusion.

The inner semiconductive layer prevents build-up of excessive electrical field strength at the individual wires of the flexible conductor and partial discharges between the conductor and the insulation.

The outer semiconductive layer serves as a core shield and performs the following tasks:

- Protection against electric shock
- Avoidance of partial discharges in the conductor assembly
- Generation of the radial electrical field in the insulation
- Discharge of current in the event of a fault.

The core shield is thus an integral component of the protective-earth conductor.

The resistance between the protective-earth conductor and any point on the outer semiconductive layer must not exceed 500 Ω . The protective-earth conductor, which touches the core shield, is covered with semiconductive rubber and ensures longitudinal conductivity of the system. The figure below shows the cross-section of a MV-cable with inner and outer semiconductive layers.

In addition to the electrical requirements, the core shield in flexible electric cables for mining applications must also be able to cope with the high (sometimes very high) mechanical stresses.

Metal shields are more liable to become defective when used in flexible electric cables for mining applications and are inferior to shields made of semiconductive rubber material.

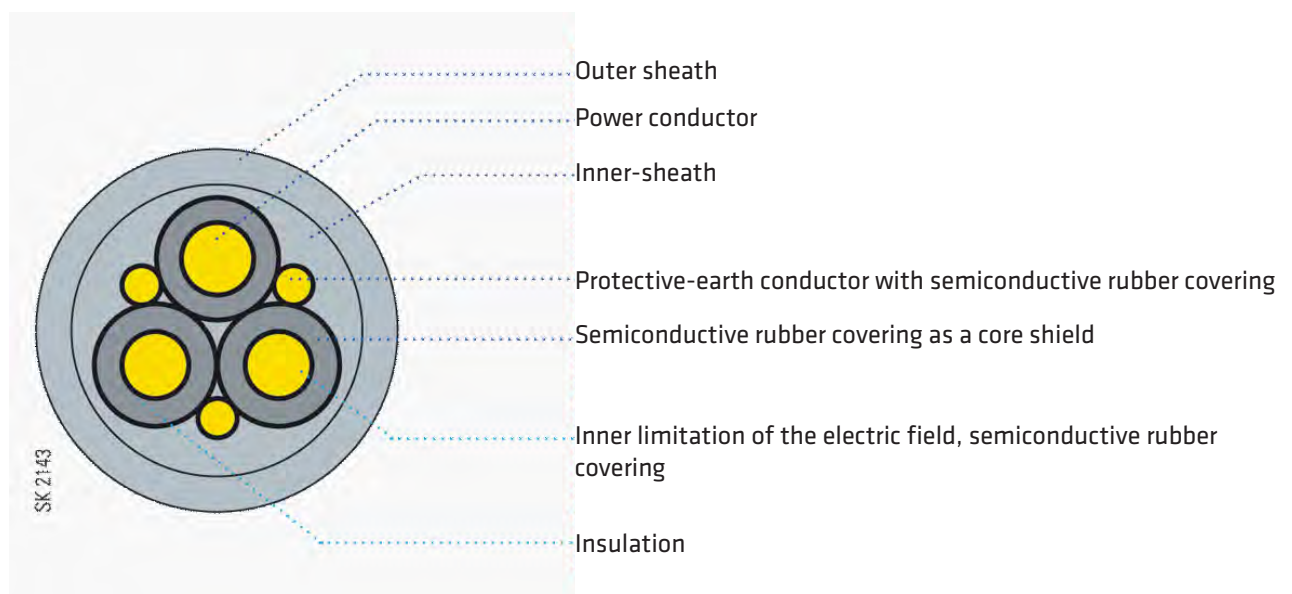

Mining cables

Core arrangement

The basic criteria of the core arrangement for flexible electric cables for mining applications are summarized in the adjacent table.



In round flexible electric cables, the individual cores are arranged by laying them up. Up to four cores are laid up without a central element. Five cores and above are laid up around a centre, which can also consist of three-core stranded elements.

A stretched core in the centre of the flexible cable (as the actual centre or placed in the centre) is not permitted according to the DIN VDE standards. A stretched core at the centre of the flexible cable would quickly result in premature failure of the conductor due to breakage, especially in flexible electric cables for mining applications.

A maximum of three core layers is best for the conductor assembly. Investigations have shown that, if there are more than three layers, the internal stability of the flexible cable and in consequence the service life is reduced as a result of increasing secondary and relative forces between the cores.

The length of lay S is a design feature used for laying up the conductor assembly (see table) and influences the bending flexibility and the bending stability. The length of lay is an important factor for the service life of flexible electric cables for mining applications.

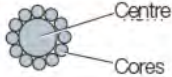
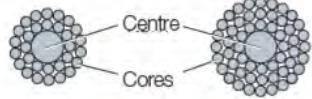
Round flexible cables

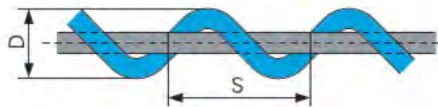
 <p>2x 3x 4x</p>	<p>Laying up of two to four cores without a centre</p>
 <p>Centre Cores</p>	<p>Laying up of five or more cores with centre Special design: the centre comprises three cores</p>
 <p>Centre Cores</p>	<p>Maximum three-layer design (standard up to 44 cores)</p>
 <p>Stretched core</p>	<p>A stretched core in the centre of a flexible cable is not permitted</p>
 <p>D S</p>	<p>The length of lay S is the length, measured in the direction of the lay, over which a core circumscribes 360° around the laying axis. It is given as a multiple of the diameter D over the conductor assembly, e.g. $S = 8 \times D$.</p>

The table below shows the normal lengths of lay in flexible electric cables for mining applications.

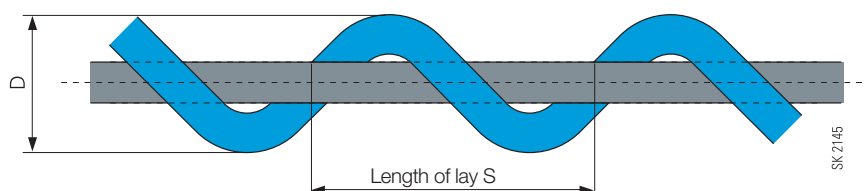

Type of cable	Length of lay for flexible electric cables for mining applications		Flexible cables
Flexible reeling cables			
R-(N)TSCGEWOEU		7 x D	PROTOLON (M)-R
(N)TSCGEWOEU		12 x D	TENAX M
Rubber-sheathed flexible cables			
(N)SHOEU and NSSHOEU	Power cable	15 x D	PROTOMONT (M),
	Control Cable	25 x D	PROTOMONT
Flexible cables for trailing operation			
(N)TSCGEWOEU		10 x D	PROTOLON (SB-SAM)
NTSCGEWOEU		6,5 x D	TENAX SAS
Trailing cables for dredger			
NTSCGEWÖU		10 x D	PROTOLON (ST)
Rubber-sheathed flexible fibre-optic cables	Especially laid-up around a GFK support element		OPTOFLEX (M)
Medium-voltage flexible cables			
F-(N)TSCGEWÖU		12 x D	PROTOLON (M)-F
Medium-voltage flexible cables			
(N)3GHSSYCY		12 x D	SUPROMONT
Underground chain cables			
NSSHCGEOEU, NTSKCGEOEU		6 x D	PROTOMONT(V), (VO)
NSSHKCGEOEU		6 x D	TENAX CTE
Data, signal and control cables for mining installations			
2YSLGCGÖU	Laid-up pairs	≥ 25 x D	PROTOMONT MSR-Mining
	Laid-up cores	≥ 15 x D	
Underground reeling cables			
NSHTOEU		5 x D	CORDAFLEX (S)
NSSHCGEOEU		5 x D	PROTOMONT (S)
NTSKCGEOEU		7 x D	TENAX LK

Mining cables

Support elements

Flexible electric cables for mining applications should not be stressed above the limits set out in table „Maximum tensile loads“ on page 203 for the permissible tensile forces. If higher tensile forces are expected, support elements have to be provided as part of the structure of the cable. There are several possibilities for integration of support elements in cables.

Two variants are normally used:

- A support element located in the centre of the cable or
- A braid between the inner and outer sheath

The force/elongation diagram in the figure shows the characteristic of these cables with different arrangements of support elements as compared to a cable without a support element.

After a compacting phase, in which the individual cable elements are initially pulled together, until the copper conductor begins to bear the tensile force, the cable without a support element remains linear in the first section of the curve (curve C). In the next phase, elongation increases considerably on a slight increase of force.

Cables with a braid as a support element between the inner and outer sheath behave in the first section of the curve (curve B) in a similar manner to cables without a support element. The braid becomes effective as a support element and bears the applied force only after the force and the consequent elongation have increased over a certain period of time. The tensile force, which is borne, increases with less elongation than that of the cable without a support element. The braid as a support element can prevent the cable, e.g. from tearing.

Cables with a central support element behave differently provided that the support element was correctly dimensioned. The support element bears the tensile forces from the very beginning and thus relieves the copper conductor (curve A).

The force/elongation characteristics of the support elements and of the copper conductors are decisive for correct design of the support element and dimensioning of the flexible cables. The actual design should be worked out in close co-operation with the cable manufacturer.

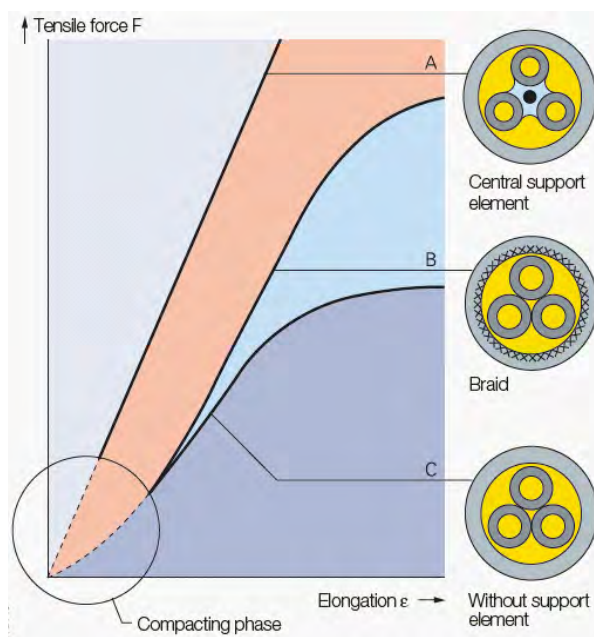

Anti-torsion braid

Flexible electric cables for mining applications are often fitted with an anti-torsion braid between the inner and outer sheath in order to minimize twisting under torsional loads. This applies to CORDAFLEX (S), PROTOLON (M)-R, TENAX LK, PROTOMONT (S) and TENAX SAS.

The effect of an anti-torsion braid on the angle of torsion α with increasing torsional moment for comparable cables with and without an anti-torsion braid is shown in the figure below.

The flexible cable with anti-torsion braid tends to twist less than the flexible cable without a braid for the same torsional moment.

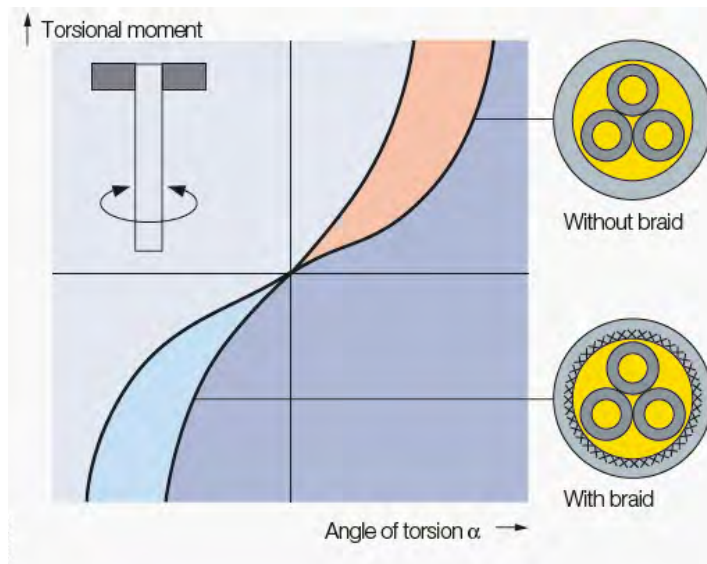

Mining cables

Cable Drum Overview

Drum size	Weight	Dimensions	Volume
	kg	Ø x width cm	m ³
051	9	50 x 46	0.09
071	23	71 x 48	0.19
081	28	80 x 48	0.26
091	43	90 x 64	0.45
101	50	100 x 64	0.70
121	125	125 x 76	1.09
141	145	140 x 95	1.37
161	210	160 x 95	2.01
181	280	180 x 110	2.80
200	380	200 x 110	4.24
220	500	224 x 138	5.44
224	700	240 x 138	7.26
281	900	280 x 138	10.10
300	1100	300 x 170	12.14
320	1200	320 x 170	18.10
340	1400	340 x 220	20.43

Comparison

Cross section metrical mm ²	mm ²	AWG-Sizes
0.75	0.653	19
	0.823	18
	1.04	17
1.5	1.31	16
	1.65	15
2.5	2.08	14
	2.62	13
4.0	3.31	12
	4.17	11
6.0	5.26	10
	6.63	9
10.0	8.37	8
	10.55	7
16.0	13.30	6
	16.77	5
25.0	21.15	4
	26.67	3
35.0	33.63	2
	42.41	1
50	53.48	1/0
70	67.43	2/0
95.0	85.03	3/0
120.0	107.20	4/0
	126.64	250 MCM
150.0	152.00	300 MCM
185.0	177.35	350 MCM
	202.71	400 MCM
240.0	253.35	500 MCM
400.0	380.00	750 MCM
500.0	506.71	1000 MCM
625.0		

AWG = American Wire Gage

Mining cables

Worldwide Prysmian Group mining cables acc. to local standards

Brandname	Cable Type	Standard	Country
Minemaster	Type 210; 241; 275; etc.	AS/NZS 1802	Australia
Minemaster	Type 409; 441; 450; etc.	AS/NZS 2802	Australia
Tech Cables	interlocked armour	based on CSA	Canada
Mold cured	SHD-GC; G-GC; G; SOW	ICEA, CSA	USA
Airguard	MPF; MPF-GC	ICEA, CSA	USA
Fiber Optic Mining	RLTM; S816; S835; S946	US-standards	USA
China Mining Cables	MYP; MYPT; MCPJB; MCPT	MT 818	China
Superprene Mining	SHD-GC; G-GC; SOW; G	ICEA, NEMA/NBR	Brazil
Tunnelflex	FE40Pu; FG70R 1kV	Italian standard	Italy

Contact:

Global:	miningcables-global@prysmiangroup.com
China:	miningcables-china@prysmiangroup.com
Asia:	miningcables-asia@prysmiangroup.com
Australia:	miningcables-australia@prysmiangroup.com
North America:	miningcables-northamerica@prysmiangroup.com
South America:	miningcables-southamerica@prysmiangroup.com
Europe:	miningcables-europe@prysmiangroup.com

Prysmian Kabel und Systeme GmbH
Alt Moabit 91D
10559 Berlin
Germany
T +49 (0) 30 3675 0
F +49 (0) 30 3675 40
www.prysmiangroup.com

© by Prysmian Kabel und Systeme GmbH 2016

Issue: January 2016

The preparation of text and illustration has been carried out with great care. Nevertheless mistakes can not be excluded. Do not scale the drawings. All photographs are the exclusive property of Prysmian Group.
Prysmian Group does not accept any liability for casual or consequential damage in connection with the use of this catalog. Improvement proposals and advices are to be sent to the above address.

All rights reserved. This document may not be copied in whole or in part, be reproduced, translated into another language or stored on electronic media.

Please note: Prysmian Group herewith warrants that the delivery items contained in this catalogue will be of the agreed nature and quality upon passing of the risk. Aforementioned nature of the delivered items shall be exclusively rated and measured by the sales and purchase agreements made in writing between Prysmian Group and the purchaser about nature and quality, properties and characteristic performance features of the respective delivery item. Illustrations and information contained in catalogues, price lists and other information material disclosed to the purchaser by Prysmian Group as well as any information describing the product shall be only legally binding, if expressly being referred to as binding information. Under no circumstances, such information shall be taken as guarantee for the special quality or nature of the delivery item. Such quality guarantees must be explicitly agreed upon in writing. Prysmian Group herewith reserves the right to modify the content of the catalog at any time.

AND BEST IN CLASS R&I
STRONGER PLATFORM TO ENHANCE CUSTOMER SERVICE
DNS **LINKING THE FUTURE** LEADING TE
WORLDWIDE LEADER

Prysmian
Group

